



**National
Coaching
Certification
Program**



Coaching
Association
of Canada

Community Coaching – Cross-Country Skiing
REFERENCE MATERIAL



*Community Coaching
Cross-Country Skiing*

REFERENCE MATERIAL



Community Coaching Cross-Country Skiing

REFERENCE MATERIAL



At this stage fundamental movement skills are mastered, motor development emphasized and basic cross-country ski skills learned. For optimal sport-specific acquisition, all basic ski skills, both classic and skating, should be learned before the end of this period.

Cross-Country Skiing - A Sport For Life

Prepared under the authority of
Cross Country Canada's
Coach and Athlete Development Committee



The National Coaching Certification Program is a collaborative program of the Government of Canada, provincial/territorial governments, national/provincial/territorial sport organizations, and the Coaching Association of Canada.

Partners in Coach Education



The programs of this organization are funded in part by Sport Canada.



Canadian
Heritage

Patrimoine
canadien

Sport Canada

© This document is copyrighted by the Coaching Association of Canada (2010) and its licensors. All rights reserved.

Printed in Canada.



ATHLETE & COACH DEVELOPMENT PROGRESSION

Athlete Age	LTAD Stage	NCCP Context
23 +/- males 23 +/- females	Training to Win (T2W)	Competition Coaching: High Performance (CCHP)
20 - 23 +/- males 19 - 23 +/- females	Training to Compete (T2C)	Competition Coaching: Development Advanced Gradation (CCDAG - T2C)
16 - 20 +/- males 15 - 19 +/- females	Learning to Compete (L2C)	Competition Coaching: Development (CCD – L2C)
12 - 16 males 11 - 15 females	Training to Train (T2T)	Competition Coaching: Introduction (CCI – T2T)
9 - 12 males 8 - 11 females	Learning to Train (L2T)	Competition Coaching: Introduction (CCI – L2T)
6 - 9 males 6 - 8 females	FUNdamentals	Community Coaching: (CC)
0 - 6	Active Start	Community Coaching: Introduction (ICC)





Illustration by Doris Barrette



Table of Contents

Section 1 - Introduction and Setting the Scene

1.1	Why Sport Experiences are Important for Children.....	1
1.1.1	Why Choose Cross-Country Skiing?.....	3
1.2	The Role of a Community Coach.....	4
1.2.1	Major Functions and Tasks of a Community Coach.....	4
1.2.2	Skill Development Program (SDP) Coaches.....	5
1.3	Glossary of Terms	7

Section 2 - Children and Their Sport Needs

2.1	Stages of Long Term Athlete Development (LTAD).....	11
2.1.1	The LTAD Framework for Cross-Country Skiing	11
2.1.2	The LTAD Stages for Cross-Country Skiing	12
2.1.3	FUNDamentals Stage of Development.....	14
2.1.4	Coaching Tips	15
2.2	Physical Literacy	16
2.2.1	The Difference Between Fundamental Movement Skills and Fundamental Sport Skills	17
2.2.2	Physical Literacy During the FUNDamentals Stage of Development.....	18
2.3	Detailed Growth and Development Considerations	20
2.4	CCC Athlete Development Grid	26
2.5	Trainability.....	28

Section 3 - Values and Ethics in Coaching

3.1	Introduction to Making Ethical Decisions	31
3.1.1	Values and Ethics: What Are They?.....	31
3.1.2	The Ethical Decision-Making Process.....	31
3.2	Examples of Coaching Situations That Have Ethical Implications	33
3.2.1	What Influences How You See?.....	38
3.3	NCCP Code of Ethics.....	39
3.3.1	Ethical Principles and Their Corresponding Behaviours/ Expectations	40
3.4	A Simplified Ethical Decision-Making Framework	41
3.5	Community Sport as a Discrimination-Free Zone	43
3.6	A Participant-Centred Environment.....	46
3.7	Sport and Self-Esteem	51
3.7.1	Are the Children Having Fun?	55
3.8	How Parents Can Encourage Girls to Play Sport.....	56



Section 4 - Teaching Classic Technique

4.1	General Factors to Consider When Teaching Technique	60
4.1.1	Checklist of Important Considerations	60
4.1.2	Role Models/Video Replay	61
4.1.3	Snow Play Goals	61
4.1.4	Ski Exercises	62
4.2	Teaching Classic Technique	65
4.2.1	Classic Technique Checklists	66
4.3	Teaching Cross-Country Ski Skills to Children	70
4.3.1	Skill Criteria and Evaluation Benchmarks - Level 1	70
4.3.2	Skill Checklist – Level 1	75
4.3.3	Skill Criteria and Evaluation Benchmarks - Level 2	76
4.3.4	Skill Checklist – Level 2	81
4.3.5	Skill Criteria and Evaluation Benchmarks - Level 3	82
4.3.6	Skill Checklist – Level 3	87
4.3.7	Skill Criteria and Evaluation Benchmarks - Level 4	88
4.3.8	Skill Checklist – Level 4	93
4.3.9	Games for Teaching Technique	94
4.3.10	Progress Report	103

Section 5 – Designing an Overall Plan for the Season

5.1	Designing a Seasonal Plan	107
5.1.1	Seasonal Plan Checklist	107
5.1.2	Incorporating Special Activities	107
5.1.3	Seasonal Plan Chart	109
5.1.4	Seasonal Plan Worksheet	111
5.2	Designing a Practice Plan	115
5.2.1	Introducing Pre-Ski Season Activities	116
5.2.2	Sample Pre-Ski Season Practice Plans	117
5.3	Practice Plans: FUNdamentals Stage of Development – Level 1	125
5.4	Practice Plans: FUNdamentals Stage of Development – Level 2	160
5.5	Practice Plans: FUNdamentals Stage of Development – Level 3	206
5.6	Practice Plans: FUNdamentals Stage of Development – Level 4	282
5.7	Nature and Environment	359

Section 6 - Preparing for Your Practice Coaching Session

6.1	Tips for Leading a Practice Session	365
6.2	Self Assessment Sheet	369
6.3	Giving Feedback	373

Section 7 - Equipment Selection and Ski Preparation

7.1	Ski Equipment	377
-----	---------------------	-----



7.1.1	Know the Terms	377
7.1.2	Selecting the Right Equipment.....	378
7.1.3	Ski Equipment Considerations for Children in the FUNdamentals Stage of Development	380
7.1.4	Binding Placement	381
7.2	How to Care for Your Ski Equipment.....	383
7.2.1	Ski Care	383
7.2.2	Ski Care Considerations for Children.....	383
7.3	Base Preparation, Glide and Grip Waxing	384
7.3.1	Base Preparation	384
7.3.2	Factors That Affect the Performance of Waxes.....	385
7.3.3	Application of Glide Wax	386
7.3.4	Application of Grip Wax.....	388
7.3.5	Waxing Skis for Children	389

Section 8 - Introducing Competition to Children

8.1	Children and Competition.....	393
8.1.1	The Benefits of Competition.....	393
8.1.2	Getting Started the Right Way!	394
8.1.3	What Does Success Mean to a Child?.....	395
8.2	Parents Code of Conduct.....	397
8.3	Competition Model for Cross-Country Skiing	398
8.3.1	The Different Race Formats.....	398
8.3.2	An Appropriate Competitive Pathway.....	399
8.3.3	Racing Rocks!.....	400
8.3.4	Guidelines for Organizing Other Club Events/Special Activities	404
8.4	Competition and the Community Coach	406
8.4.1	Tasks of a Community Coach – Regional Races	406
8.4.2	The Basic Rules of a Cross-Country Ski Competition.....	408

Section 9 - Teaching Skating Technique

9.1	Teaching Skating Technique	411
9.1.1	Skating Technique Checklists	411

Section 10 - Practice Coaching Session

10.1	Self-Assessment Sheet.....	415
10.2	Facility Safety Checklist	421
10.3	Assessment Tools for Coaches.....	425
10.3.1	Are the Children Having Fun?	426
10.3.2	Are You Spreading Your Attention Around?.....	427
10.3.3	How Are You Acting During Competitions?	428



Section 11 – Evaluation

11.1 NCCP Community Coaching Certification Process..... 431
11.1.1 NCCP Community Coaching Certification Steps.....433
11.2 Community Coaching Flowchart436
11.3 Recommended Training Standards for Coaches 437
11.4 NCCP Community Coaching Certification Test439
11.5 NCCP Community Coaching Experience Form443
11.6 Evaluation Form445

Appendix A: Coaching Athletes with a Disability

A.1 Introduction449
A.1.1 Coaching Athletes with a Disability449
A.1.2 Glossary of Terms449
A.2 Important Factors Influencing the Development Process for Athletes
with a Physical Disability453
A.3 Stages of LTAD for Athletes with a Disability 461
A.3.1 LTAD Progression Chart462
A.3.2 Active Start/Awareness.....463
A.3.3 FUNdamentals/First Contact464
A.3.4 Learning to Train.....465
A.3.5 Active for Life465
A.3.6 Athlete Development Pathway Chart466
A.3.7 NCCP: AWAD Stream.....467
A.3.8 Athlete Development Grid.....468
A.4 Considerations for Working with Athletes with a Disability470
A.4.1 General Considerations470
A.4.2 Considerations Specific to Cross-Country Skiing472
A.5 Modified Games479

RESOURCE LIBRARY
The purpose of the NCCP Reference Materials is to provide you, as a community coach,
with a resource “library” to assist you in the ongoing development of your coaching skills.
The content of this document is intended to complement the information provided in your
Introduction to Community Coaching materials, and is directed primarily at supporting you
in your role as a coach working with children in the FUNdamentals age range.



SECTION 1 - INTRODUCTION AND SETTING THE SCENE



Coaching Tip: Physical literacy refers to competency in movement and sports skills (fundamental movement skills and fundamental sport skills = physical literacy). Physical literacy should be developed before the onset of the adolescent growth spurt.

Source: Cross-Country Skiing A Sport For Life



1.1 Why Sport Experiences are Important for Children

Physical Activity and Health

Compelling scientific evidence demonstrates that physical activity plays a key role in improving health and in preventing disease, disability and premature death:

- Physical activity reduces the risk of many conditions, including heart disease, obesity, high blood pressure, Type II diabetes, osteoporosis, stroke, depression and colon and breast cancer. The reduction in risk is comparable to the avoidance of tobacco use.
- Physical activity is fundamental to healthy childhood growth and development.
- Physical activity increases life and health expectancy. People who are active tend to live longer and healthier lives. Physical activity compresses the morbidity curve, reducing the period of illness and dependency, and the need for institutionalization, in the latter stages of life.
- Physical inactivity is a primary risk factor associated with Type II diabetes.
- People who are regularly active also tend to eat healthier and maintain a healthy body weight. Despite this evidence, high levels of physical inactivity constitute a serious threat to public health in Canada.
- 64% of Canadians are not active enough for optimal health benefits. While physical inactivity levels declined during the 1980s and early 1990s, improvements have stalled since 1995.
- The health of Canada's children and youth is at risk due to unacceptably high levels of physical inactivity and rising rates of obesity. More than one-half of our young people are not active enough to lay a solid foundation for health and well-being. An obese pre-schooler has a 25% chance of becoming an obese adult. An obese teenager has a 75% chance of remaining obese for life.
- 60% of older adults are not sufficiently active to achieve full health benefits. Due to this high level of physical inactivity, older adults, in general, are at higher risk of poor health.
- It is estimated that physical inactivity results in at least 21,000 premature deaths annually.
- It is estimated that physical inactivity costs the health care system at least \$2.1 billion annually in direct health care costs.

Physical Activity and Health, Population & Public Health Branch, Health Canada





Sport and Physical Activity Quotes

“Because physical activity is so directly related to preventing disease and premature death and to maintaining a high quality of life, we must accord it the same level of attention that we give to other important public health practices that affect the entire nation. Physical activity thus joins the front ranks of essential health objectives, such as sound nutrition, the use of seat belts, and the prevention of the adverse effects of tobacco...

Most significantly, regular physical activity greatly reduces the risk of dying from coronary heart disease, the leading cause of death in the United States. Physical activity also reduces the risk of developing diabetes, hypertension, and colon cancer, enhances mental health, fosters healthy muscles, bones and joints, and helps maintain function and preserve independence in older adults.”

US Surgeon General's Report on Physical Activity and Health

“Kids who are regularly active are less susceptible to stress, perform as well or better academically, exhibit positive attitudes about school and themselves, are less aggressive and play better with other children.”

The Canadian Association for Health, Physical Education and Recreation

“More than 80% of Canadians between the ages of ten and 24 who are active have never smoked.”

The Campbell's Survey, Canadian Fitness and Lifestyle Research Institute

“Physical activity sharply declines during adolescence. Childhood and adolescence may thus be pivotal times for preventing sedentary behavior among adults by maintaining the habit of physical activity throughout the school years.”

US Surgeon General's Report on Physical Activity and Health

“Physical activity programs and initiatives face the challenge of a highly technological society that makes it increasingly convenient to remain sedentary and that discourages physical activity in both obvious and subtle ways.”

US Surgeon General's Report on Physical Activity and Health





“In particular, sport properly played demonstrably teaches the benefits of self-discipline, perseverance, teamwork and the pursuit of excellence.”

Discussion paper: Federal/Provincial/Territorial Ministers Responsible for Sport and Recreation Conference, 1995

“Whatever else you learn in school, I would like you to master at least two “life sports”, those you can play long after you are out of school.

Sports are wonderful, they can bring you comfort and pleasure for the rest of your life.

Sports can teach you so much about yourself, your emotions and character, how to be resolute in moments of crisis, and how to fight back from the brink of defeat. In this respect, the lessons of sport cannot be duplicated easily.”

Arthur Ashe, Wimbledon Tennis Champion, in his letter to daughter Camera just prior to his death.

1.1.1 Why Choose Cross-Country Skiing?

Cross-country skiing is an ideal “lifestyle” sport for individuals of all ages and abilities. Everyone can and should participate, whether they do so casually during the winter to enjoy the outdoors, or train all year round and aspire to become a World Cup champion.

The sport has a strong family orientation. Skiers range in age from three to 100 years, and clubs traditionally focus on events/activities in which the entire family can participate. Many high performance competitions encourage family participation as well, with categories ranging from seven and under to 70 plus.

This is a sport that is low impact and very easy on the joints. It is almost injury free. It activates all the body’s major muscle groups, and is an excellent developer of the cardiovascular system. Physically, cross-country skiing is an ideal activity!!

For most Canadians, cross-country skiing is accessible. Facilities are available in many areas of Canada, and individuals can move from one community to another and continue their involvement with the sport. Moreover, due to the nature of the sport, anyone can enjoy some level of activity without costly lessons or months of training. Most important of all, this is an outdoor winter activity that allows people to appreciate our long Canadian winters and the beautiful country in which we live.

Cross Country Canada believes and teaches that sport is an ethical pursuit, one which builds character and shapes attitudes.





1.2 The Role of the Community Coach

The Community Coach is trained to lead a skill development program at the club level. They are responsible for:

- Teaching an effective series of skill development sessions for children in the FUNdamentals stage of athlete development (e.g. CCC's Jackrabbit Program).
- Providing a learning environment for participants that is:
 - ✓ **Comfortable.** Incorporates a proper understanding of equipment, clothing and other requirements for participating in outdoor winter activities.
 - ✓ **Educational.** Provides the opportunity for progressive improvement;
 - ✓ **Enjoyable.** Is fun and motivating through the provision of activities that: are stimulating and novel and contain an appropriate degree of challenge.
 - ✓ **Safe.** Incorporates appropriate safety and risk management procedures, including the development of an appropriate Emergency Action Plan (EAP).
 - ✓ **Age Appropriate.** Adheres to the principles of CCC's Long Term Athlete Development (LTAD) model.
 - ✓ **Ethical.** Ascribes to the NCCP Code of Ethics.
 - ✓ **Parent Supported.** Parents are engaged and supportive of the objectives and methodology of the program.
- Providing leadership that will:
 - ✓ motivate children to learn more, ski more and continue in the sport; and
 - ✓ meet the approval of the parents.

1.2.1 Major Functions and Tasks of a Community Coach

Responsibilities include the following:

- providing leadership with regard to sport equipment - guidance regarding clothing and equipment selection, teaching good ski care habits, teaching ski preparation skills (refer to section 7 of this document and section 3 of the Introduction to Community Coaching Reference Material);
- ensuring a suitable setting for practice sessions - appropriate signage and boundaries, age/skill and lesson-appropriate terrain, appropriate grooming, etc. (refer to section 4.1 of this document and section 4.1 of the Introduction to Community Coaching Reference Material);
- educating parents to help ensure positive sport experiences for the children in the program;
- developing a comprehensive and effective seasonal plan;
- planning and delivering effective practice sessions (dryland, on-snow and classroom sessions);





- teaching and evaluating technique;
- tracking progress and providing technique awards, report cards, etc.;
- tracking progress and/or providing opportunities for skiers to achieve program awards;
- recruiting parents for various roles (coaches, officials, administrators, etc.);
- mentoring developing coaches;
- liaising with the club head coach and the leaders of the skill development groups above and below the skill level you are working with;
- providing inspiration and enthusiasm;

Additional Coaching Tips:

- Refer to section 8.1.4 of the Introduction to Community Coaching Reference Material for a detailed checklist of common tasks; and
- Refer to section 8.4 of this Reference Material for detailed checklists of tasks relating to competitions.

1.2.2 Skill Development Program (SDP) Coaches

SDP coaches lead group sessions. If a group of children are in the Active Start stage of development this role may be filled by community coaches “in training”, but if the group is in the FUNDamentals stage of development, they must be “trained” community coaches - technically competent, good role models and able to present the program well. General responsibilities might include the following:

- planning and conducting activity/practice sessions for their own group of children (dryland, on-snow and classroom sessions);
- teaching and evaluating ski technique;
- teaching ski preparation skills and respect for ski equipment; and
- providing inspiration and enthusiasm.

If your club SDP is large, it may be necessary for one of the coaches to take the role of team leader in order to oversee the planning and coordination of all the group sessions. This person requires a good understanding of the program. Responsibilities might include the following:

- coordinating the training and development of all the coaches working with SDP program, including new coaches recruited to replace retiring coaches;





- ensuring suitable substitutes for coaches who cannot make an activity/practice session;
- liaising with the club head coach and the next level of athlete development program above the SDP;
- ensuring the provision of current information on equipment selection, ski preparation etc.;
- ensuring the coordination of games when the various SDP groups assemble together, as well as the coordination of appropriate equipment; hoops, soccer balls etc.;
- coordinating the regular involvement of appropriate “role models”; and
- coordinating use of the ski area to suit the needs of the different ages/skill levels within the groups.

Skill development during the FUNdamentals stage of athlete development should be well-structured, positive and FUN!





1.3 Glossary of Terms

- ❑ **Adolescence** is a difficult period to define in terms of onset and termination. During this period, most bodily systems become adult both structurally and functionally. Structurally, adolescence begins with an acceleration of the rate of growth in stature, which marks the onset of the adolescent growth spurt. The rate of statural growth reaches a peak, begins a slower or decelerative phase, and finally terminates with the attainment of adult stature. Functionally, adolescence is usually viewed in terms of sexual maturation, which begins with changes in the neuroendocrine system prior to overt physical changes and terminates with the attainment of mature reproductive functions.
- ❑ **Ancillary capacities** refer to the knowledge and experience base of an athlete and includes warm-up and cool-down procedures, stretching, nutrition, hydration, rest, recovery, restoration, regeneration, mental preparation, and taper and peak. The more athletes know about these training and performance factors, the more they can enhance their training and performance levels. When athletes reach their genetic potential and physiologically cannot improve any more, performance can be improved by using the ancillary capacities to full advantage.
- ❑ **Childhood** ordinarily spans the end of infancy – the first birthday – to the start of adolescence and is characterized by relatively steady progress in growth and maturation and rapid progress in neuromuscular or motor development. It is often divided into early childhood, which includes pre-school children aged one to five years, and late childhood, which includes elementary school-age children aged six through to the onset of adolescence.
- ❑ **Chronological age** refers to the number of years and days elapsed since birth. Growth, development, and maturation operate in a time framework; that is, the child's chronological age. Children of the same chronological age can differ by several years in their level of biological maturation. The integrated nature of growth and maturation is achieved by the interaction of genes, hormones, nutrients and the physical and psychosocial environments in which the individual lives. This complex interaction regulates the child's growth, neuromuscular maturation, sexual maturation and general physical metamorphosis during the first two decades of life.
- ❑ **Developmental Age** refers to the interrelationship between growth and maturation in relation to the passage of time. The concept of development also includes the social, emotional, intellectual, and motor realms of the child. Developmental age reflects the true overall situation of an individual's growth and maturation and may be thought of as an index of development stated as the age in years of an individual and determined by specified standardized measurements such as motor and mental tests and body measurements. The terms "growth" and "maturation" are often used together and sometimes synonymously. However, each refers to specific biological activities. Growth refers to observable, step-by-step, measurable changes in body size such as height, weight, and percentage of body fat. Maturation refers to qualitative system changes, both structural and functional in nature, in the organism's progress toward maturity; for example, the change of cartilage to bone in the skeleton.





- ❑ **Peak height velocity (PHV)** is the maximum rate of growth in stature during growth spurt. The age of maximum velocity of growth is called the age at PHV.
- ❑ **Periodization** is time management. As a planning technique it provides the framework for arranging the complex array of training processes into a logical and scientifically based schedule to bring about optimal improvements in performance.
- ❑ **Physical Literacy** refers to the mastering of fundamental motor skills and fundamental sport skills.
- ❑ **Post-natal growth** is commonly, although sometimes arbitrarily, divided into three or four age periods, including infancy, childhood, adolescence and puberty.
- ❑ **Puberty** refers to the point at which an individual is sexually mature and able to reproduce.
- ❑ **Skeletal age** refers to the maturity of the skeleton determined by the degree of ossification of the bone structure. It is a measure of age that takes into consideration how far given bones have progressed toward maturity, not in size, but with respect to shape and position to one another.
- ❑ **Speed** may be thought of as the ability to move a limb, limbs, or the whole body at the greatest possible velocity. In addition, speed involves the capability to react to a stimulus or signal (such as a starting signal, stumble, or fake/deke) in the shortest possible time.
- ❑ **Trainability** refers to the generic endowment of athletes as they respond individually to specific stimuli and adapt to it accordingly. Malina and Bouchard (1991) defined trainability as “the responsiveness of developing individuals at different stages of growth and maturation to the training stimulus.”
- ❑ **Window of Optimal Trainability** refers to a point in the development of a specific behaviour when experience or training has an optimal effect on development. The same experience, introduced at an earlier or later time, has no effect on or retards later skill acquisition.





REFERENCES

Canadian Sport for Life. *Long-Term Athlete Development Resource Paper*, Canadian Sport Centres, 2005, pp. 8-11.

Supporting Healthy Living for Canadians. *Physical Activity and Health*, Population & Public Health Branch, Health Canada.

Cross Country Canada, *Cross-Country Skiing, A Sport For Life*, 2007.





SECTION 2 - CHILDREN AND THEIR SPORT NEEDS



Coaching Tip: The coach is the central leadership figure in the sporting life of an athlete.

Source: Unknown



This section on Children and Their Sport Needs expands on the information provided in section 2 of your Introduction to Community Coaching Reference Material, and is directed primarily at supporting you in your role as a coach working with children in the FUNdamental stage of development.

2.1 Stages of Long Term Athlete Development (LTAD)

Cross-country skiing is a late specialization sport. During the first three stages of Canada's LTAD model, children grow and improve within the sport through programs permitting a broad exposure to activities that develop overall motor and sport skills. Following the first three stages, there is a transition to either further development and excellence in cross-country skiing or life-long participation in skiing and/or other sports at the recreational or less competitive level. For athletes who wish to pursue excellence, increasing specialization in cross-country skiing and an expanding focus on competition permit them to mature athletically and aspire to national and international podiums. Regardless of the level of excellence or sport-mastery achieved however, participation in cross-country skiing – a “sport for life” - can enhance the health, fitness and mental well-being of Canadians of all ages.

2.1.1 The LTAD Framework for Cross-Country Skiing

The first three stages encourage physical literacy and “Sport for All”:	The next four stages focus on development and competitive excellence:	The final stage encourages life-long physical activity:
1. Active Start 2. FUNdamentals 3. Learning to Train	4. Training to Train 5. Learning to Compete 6. Training to Compete 7. Training to Win	8. Active for Life





Figure 2.1

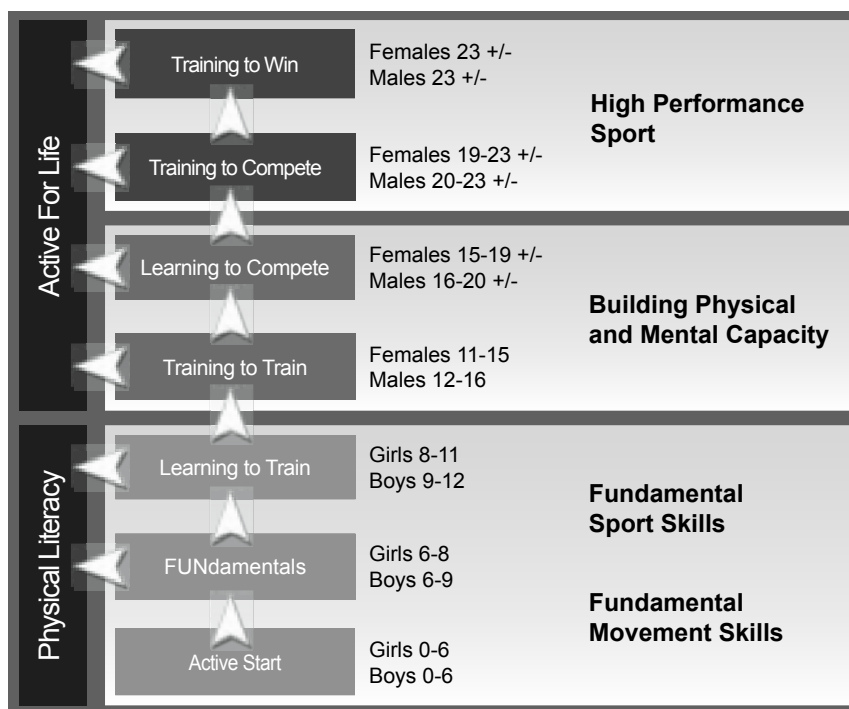

2.1.2 The LTAD Stages for Cross-Country Skiing

To promote a healthy and logical development for each athlete, the LTAD model identifies sequential stages for training and competition that respect the athlete's physical, mental and emotional development. This approach encourages lifelong physical activity for athletes of all levels of ability and disability. It also provides an effective route for athletes to pursue excellence up to and including the national and international levels of competition.

Following is an overview of the eight LTAD stages:

Active Start (Boys and Girls 0-6)

- ❑ This is an important period for acquiring the fundamental movement skills that lay the foundation for more complex movements, thereby preparing children for a physically active lifestyle.
- ❑ Young children should be physically active through active play, and encouraged to begin cross-country skiing at an early age.

FUNdamentals (Boys 6-9 and Girls 6-8)

- ❑ Fundamental movement skills are mastered, motor development emphasized and basic cross-country ski skills learned. For optimal sport specific acquisition, all basic ski skills, both classic and skating, should be learned before the end of this period.



**Learning to Train** (Boys 9-12 and Girls 8-11)

- This is an important period for motor development and **window of optimal trainability for motor-coordination**. Children are developmentally ready to acquire the general sport skills that will be the cornerstone of their athletic development.
- Fitness becomes increasingly important.

Training to Train (Males 12-16 and Females 11-15)

- This is an important period for developing aerobic capacity, which is especially critical for cross-country skiing (a lot of skiing at low intensity!).
- Social and emotional considerations are very important. Team building, group interaction and social events should be emphasized.

Learning to Compete (Males 16-20 (+/-) and Females 15-20 (+/-))

- Fitness preparation, sport and individual specific skills are developed. The development of self-awareness and independence should be emphasized.
- Training and racing should be integrated gradually and seamlessly into the overall timetable and lifestyle of the aspiring competitive athlete.

Training to Compete (Males 20-23 (+/-) and Females 19-23 (+/-))

- This is an important period for individualized fitness preparation. Fitness and medical monitoring is increasingly sophisticated, and sport and individual specific skills are mastered.
- Self-awareness and independence become increasingly important.
- Athletes learn to compete internationally.

Training to Win (Males 23 (+/-) and Females 23 (+/-))

- During this stage athletes focus on high performance and undertake multi-year preparations for major events (i.e. Olympics, World Championships).
- High performance sport specialist support is optimized, as is fitness and medical monitoring.
- All aspects of training and performance are highly individualized.
- Podium performances are the goal.

Active for Life (This stage can be entered at any age)

- There is a better opportunity to be “Active for Life” if physical literacy is achieved before the “Training to Train” stage.





2.1.3 FUNdamentals Stage of Development

At this stage fundamental movement skills are mastered, motor development emphasized and basic cross-country ski skills learned. For optimal sport specific acquisition, all basic ski skills, both classic and skating, should be learned before the end of this period.

Objectives

- To develop all fundamental movement skills and build overall motor skills.
- All basic cross-country ski skills should be learned by the end of this stage.

Optimal Windows of Trainability

- Speed development.
- Flexibility development.

The Goals

- Encouraging FUN and participation.
- Developing the ABCs of athleticism - agility, balance, coordination and speed.
- Participation in many activities/sports 4-6 times a week, year-round.
- Frequent cross-country skiing during the snow season (several times a week).
- Good technique habits developed through repeated practice; use the Jackrabbit Program "Snow Goals" Awards to encourage time on snow.
- Continued use of ski playgrounds/terrain parks.
- Developing basic cross-country ski skills (both classic and skating techniques); equal use of techniques; developing downhill abilities.
- Utilizing games to develop technique, speed, skills and fitness.
- Providing programs that are well-structured and monitored. No periodization.
- Integrated mental, cognitive and emotional development.
- Introducing basic flexibility exercises.
- Developing linear, lateral and multi-directional speed with the duration of repetitions less than five seconds.
- Introducing strength training exercises using the child's own body weight as well as medicine balls and Swiss balls.
- Developing a team/social atmosphere (increasingly important towards the end of this stage).





- Focusing on balance, agility and rhythm (on-snow).
- Introducing competition in a team environment whenever possible
- Encouraging inter-club social, skill and fitness-oriented ski activities (e.g. camps during the ski season).

Psychological Training

- Gain an awareness of the importance of mental skills.
- Exposure to positive thinking skills to build confidence and the ability to cope with stress.

Children who do not develop their fundamental motor skills by 12 years of age are unlikely to reach their genetic athletic potential.

2.1.4 Coaching Tips

- Continue to make use of settings that allow children to learn to ski naturally (terrain parks/ski playgrounds). However the practices should now be both well-structured and monitored.
- Link skill development into play and games. Learning skills should be FUN!
- At this age, children appreciate variety.
- Design activities that help children to feel competent and comfortable while being challenged.
- Make good use of the short snow season. Maximize opportunities for on-snow sessions while snow is available.
- Include activities that encourage a social atmosphere within the group. Arrange for social time following practice sessions.
- Put a big emphasis on team building.
- Treat all children in the group equally.
- Insist that the individuals in your group show respect for each other.
- Introduce on-snow skill development camps during the latter part of this stage of development.





2.2 Physical Literacy

- ❑ FUNDamental movements skills and FUNdamental sports skills = physical literacy.
- ❑ Physical literacy refers to competency in movement and sports skills.
- ❑ Physical literacy gives children the tools they need to take part in physical activity and sport, both for healthy life-long enjoyment and for sporting success.
- ❑ Physical literacy should be developed before the onset of the adolescent growth spurt.

In the Introduction to Community Coaching (ICC) workshop you were introduced to the concept of physical literacy and learned how important it was for children in the Active Start stage of development to learn fundamental movements and link them together into play. Refer to section 2.4 of your ICC Reference Material if you wish to review this information.

Figure 2.2: Learning Fundamental Movement Skills

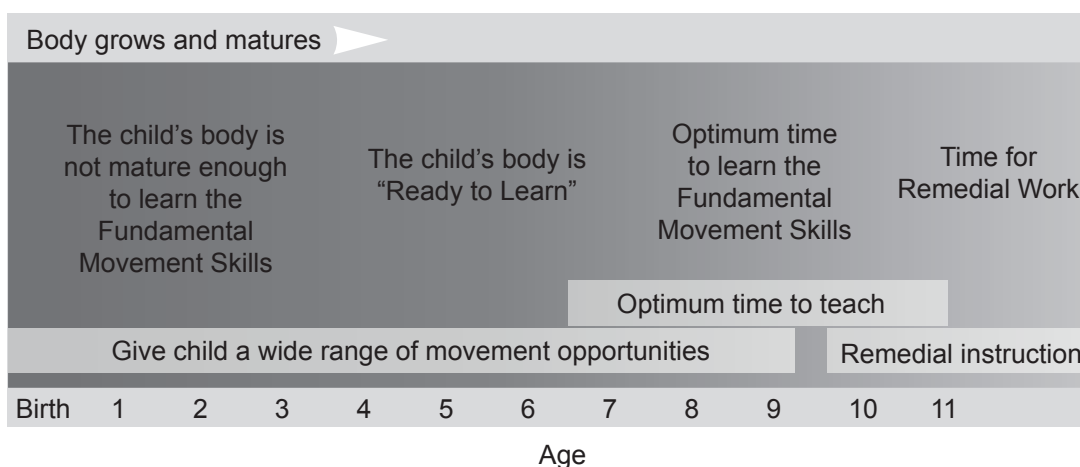

In this workshop you will learn about physical literacy during the FUNDamental stage of development. At this stage fundamental movement skills should be mastered, motor development emphasized and basic cross-country ski skills learned. For optimal sport specific acquisition, all basic cross-country ski skills, both classic and skating, should be **learned** before the end of this period.

The third stage of development (Learning to Train) will be the most important period of motor development, and a window of accelerated adaptation to motor co-ordination. You will learn more about this stage during the first CCI workshop – the L2T (Dryland) workshop. This is the stage when children are developmentally ready to acquire the general sport skills that are the cornerstones of all athletic development. For optimal sport specific acquisition, all basic cross-country ski skills, both classic and skating, should be **refined** before the end of this period.





For children to have success in sport - either as a health-related recreational activity or a competitive activity - it is important that they master fundamental movement skills before learning fundamental sport skills, and it is important that they learn fundamental sport skills before being introduced to specific techniques.

2.2.1 The Difference Between Fundamental Movement Skills and Fundamental Sport Skills

The difference can be illustrated by the following examples:

- ❑ When children learn to throw a variety of balls of different sizes with one hand or both hands, and to throw the ball at different speeds - sometimes for accuracy using a variety of different targets, and sometimes for distance - they are learning a fundamental movement skill.
- ❑ When children learn to throw a softball using a softball pitching motion, and attempt to pass the ball over home plate, they have moved from learning a “fundamental movement skill” to learning a “fundamental sport skill”.

Some further examples of this are:

❑ Kicking Skills

- ✓ In the “fundamental movement skill” stage, children should learn the basic kicking action with each foot. They should kick a wide variety of balls and try different things – e.g. kicking as far as they can, kicking to hit a target, kicking to keep the ball on the ground, kicking the ball as high in the air as they can.
- ✓ In the “fundamental sport skill” stage (e.g. soccer), children learn to kick a soccer ball without touching the ball with their hands, how hard they have to kick the ball in order to get it to another team member and how to kick the ball with the inside of the foot to increase passing accuracy.

❑ Catching Skills

- ✓ In the “fundamental movement skill” stage, children learn to catch - first with both hands together in a two handed catch, and then with one hand. They will learn to catch a wide variety of balls of different sizes and weights, to catch the ball while they are standing still and when to move towards the ball. These are skills that can later be transferred to any sport they take up.
- ✓ In the “fundamental sport skill” stage (e.g. baseball), children learn to catch a baseball using a baseball glove. As their skill level improves they learn to catch the baseball when it is thrown at them, and then when it is hit with the bat.

For more information on movement skills and sport skills refer to section 4.4 of this Reference Material.





2.2.2 Physical Literacy During the FUNDamentals Stage of Development

Objective: Learn all fundamental movement skills and build overall motor skills.

This is a critical stage for the development of physical literacy, and it is during this time that the foundations of many advanced skills are laid down.

Skill development for children this age is best achieved through a combination of unstructured play in a safe and challenging environment; and quality instruction from knowledgeable teachers/leaders/coaches in community recreation activities, schools, and minor sport programs.

- ❑ Physical Literacy during the FUNDamental Stage of LTAD Skill development during this stage should be well-structured, positive and FUN, and should concentrate on developing the ABCs – of Agility, Balance, Coordination and Speed, plus rhythmic activities.
- ❑ Hand and foot speed can be developed especially well by boys and girls during this stage and if this window of opportunity to develop speed is missed, body speed later in life may be compromised.
- ❑ This is a great age for children to take part in a wide range of sports – and they should be encouraged to take part in land-based, water-based and ice/snow based activities at different times of the year.
- ❑ It is important that all children including those with a disability, master fundamental movement skills before sport specific skills are introduced.
- ❑ Strength, endurance and flexibility need to be developed, but through games and fun activities rather than a training program.
- ❑ Learning to “read” the movements going on around them and make sound decisions during games are critical skills that should be developed at this stage.

Things to think about:

Children this age should not specialize in a single sport. Although they may well have a preferred sport that they take part in once or twice a week, they should take part in other sports or activities at least three to four times per week. Children this age have a strong sense of what is “fair” and should be introduced to the simple rules and ethics of sports. Basic tactics and decision making can be introduced.

Using equipment that is the right size, and that fits well makes learning activities much more enjoyable and also safer. Equipment swaps and rentals are one way to keep the cost of participation down – and this is particularly important for children with a disability who need specialized sports equipment.

Fundamentals – Physical Literacy Activities

- ❑ Encourage children to engage in unstructured physical play with their friends every day, regardless of the weather.





- ❑ Continue to play catching, throwing, hitting, running and other physically demanding games with both boys and girls. If possible, enroll children in programs that offer a wide variety of different activities (multi-sport programs) or in a wide range of different activities. Try as many different activities as possible.
- ❑ Attend parent-teacher, or other school meetings and advocate for quality physical education programs in the school – with sufficient time allocated (recommended allocation 150 minutes per week – 30 minutes per day) taught by a qualified physical educator.
- ❑ Don't be concerned with the score. At this age many programs that include competition don't keep score. This puts the focus of the program on learning and having fun, rather than on doing whatever it takes to win matches, games and leagues.
- ❑ Don't believe the myth that early specialization in sports such as soccer or hockey will lead to far greater performance later in life. Developing all-round athletes at this age is far better, but remember that a few sports (such as gymnastics and figure skating) do require early specialization.

This is a paramount message to coaches and parents: if the fundamental and basic sport-specific skills are not established before ages 11 and 12 respectively, athletes are unlikely to reach their optimal or genetic potential!

Children who are physically educated will:

- ❑ feel confident and be encouraged to continue to build on these skills through recreational and competitive sport activity;
- ❑ enjoy overall health benefits by developing greater physical literacy, which encourages them to be more physically active throughout their lives. Increased activity reverses the current trends in childhood and adult obesity and cardiovascular disease; and
- ❑ discover a pathway to competition that – if pursued – may lead to excellence at the international level.





2.3 Detailed Growth and Development Considerations

6-7 Years, Growth and Development of Participants

<p>General Remarks</p>	
<ul style="list-style-type: none"> • At this age the child remains fairly individualistic and self-centred; needs a lot of attention and must be in the company of an adult and/or in a small group • High dependence on parents • Acknowledges the coach as the leader • Needs to have a well-established routine in daily activities • Has no athletic or competitive background • Interest in sport activities may begin to grow 	
<p>Psychosocial</p>	
<ul style="list-style-type: none"> • Rather individualistic; often tries to expand social circle and the number of friends, especially with individuals of the same sex • Sometimes shy • Is conscious of own feelings and emotions, and of those of others toward him/her; can play on these feelings to obtain privileges • Boys and girls can be involved in the same activities without difficulty 	
<p>Learning</p>	
<ul style="list-style-type: none"> • Learns best by observing, quickly followed by doing • Short attention span (a few minutes) • Ability to reason is limited to what is readily observable • May be afraid of the unknown • Is likely to imitate and be highly imaginative; is often curious and wants to know everything 	
<p>Physical</p>	
<ul style="list-style-type: none"> • Development of the nervous system is almost complete • Rate of physical growth is constant, yet relatively slow; on average, little difference is observed between boys and girls with regard to height and weight • Head is still very fragile; bones, tendons, muscles and ligaments cannot sustain heavy loads • Always seems to be moving; coordination is not very well developed; endurance is low 	





- Resting heart rate and heart rate during exercise are higher than for adults; resting heart rate is approximately 100 bpm. Aerobic metabolism predominates during effort; low anaerobic capacity
- Sweating mechanism of children is not well developed, which reduces their capacity to dissipate heat during exercise; children are at an increased risk of overheating injuries such as hyperthermia
- Children cool off rapidly, and do not tolerate cold well, which is why it is important for them to dress appropriately for winter activities (refer to sections 3 and 6 for more information)

Preferences

- Enjoys individual activities, with some interaction with the group (e.g. tag); likes to throw, catch, hit, kick, run, jump, climb and other activities where the whole body is involved
- Enjoys all types of activities that require imagination or involve imitating an adult
- Games should encourage creativity and have few rules

To Avoid

- Activities that require repeated impact or wherein there is a risk of collision
- Repetitive activities and activities that feature too much structure (to prevent boredom and also overuse injuries)
- Exercising in a very cold or hot environment
- Using equipment that is not designed for children (i.e. too big, too heavy)
- Specialization in a sport or in a position
- Repetition of all-out efforts lasting between 20 and 60 seconds; work against a high resistance; prolonged aerobic endurance efforts
- Emphasizing the result or performance
- Negative competitive experiences
- Comparisons with other children
- Lengthy explanations
- Negative criticism



Suggestions

- All activities should take the form of games; conditions in which activities or games take place should be varied to promote the development of a variety of motor patterns and skills





- Rules should be adapted to encourage a high degree of interaction between and involvement of participants, and to increase the probability of success during the activity; modified, scaled-down equipment should be used
- Demonstrations should be highly specific, simple and aimed at the achievement of a well-defined objective; duration of activities should be relatively short, and exercises should change frequently
- Children need to be praised and complimented generously and regularly for their efforts; feedback should focus on one point only; choose the most important one; children should be encouraged to be proud of their own performance, and to congratulate others for theirs
- Basic motor abilities should be developed through games; techniques should be introduced in ways that stimulate the child's imagination (e.g. refer to a funny situation of the child's life, a cartoon)
- Encourage children to drink water, and in hot conditions ensure that there are plenty of beverages available

Examples

- Relay or obstacle races
- Somersaults, pirouettes, jumps, runs, lateral movements, rope climbing, rope skipping, use of play structures, sliding, throwing, catching, passing a ball with hands or feet, hitting a ball
- Basic strength exercises using the child's own body weight (push-ups, pull-ups, squats with own body weight)





8-9 Years, Growth and Development of Participants

General Remarks	
<ul style="list-style-type: none">• Has a high degree of imagination; being active is very important; likes to work, learn and accomplish things• Still needs a well-established routine in daily activities• Wants to act on his/her own; does not like conventions or norms, but will accept the coach's instructions if there is a sense that he/she participates in the establishment of the rules and conditions governing the activity• May have very little or no athletic background• Interest in sport activities is often high	
Psychosocial	
<ul style="list-style-type: none">• Is still individualistic and self-centred, but shows an increasing interest in the group; wants to be accepted by others, and usually shows a great deal of loyalty toward the team• Needs praise and positive feedback• Is conscious of own feelings and emotions, and of those of others toward him/her; can play on these feelings to obtain privileges• Boys and girls may be involved in the same activities without difficulty• Seeks the approval of others; may reject opportunities to interact with individuals of the opposite sex	
Learning	
<ul style="list-style-type: none">• Accepts following instructions to learn faster, and reacts favourably to positive feedback/praise; ability to concentrate and to pay attention is relatively good; can begin to make some generalizations• The emphasis should be on motor development and the learning of skills in a variety of sports• It is possible to start teaching the rules of the game and fundamental tactical principles• Is capable of assessing the angles of moving objects (e.g. balls), yet may still have some difficulty distinguishing between right and left• Ability to reason and solve problems is limited to what can be observed	



**Physical**

- Physical characteristics are similar to children aged 6-7, but coordination and stamina are better; growth rate is slow, which tends to allow for a greater degree of motor control and autonomy
- The development of the nervous system is almost complete
- Reaction time is slow; shows an increased ability to make coordinated and quick movements
- Large muscle masses (e.g. the legs) show a greater degree of development compared to smaller ones (e.g. arms, hands)
- Very little potential for increased muscle mass (hypertrophy); strength gains result primarily from increased coordination and neural factors
- Resting heart rate and heart rate during exercise are higher than for adults; aerobic metabolism predominates during effort and anaerobic capacity is low
- The sweating mechanism of children is not well developed, which reduces their capacity to dissipate heat during exercise; children are at an increased risk of overheating injuries such as hyperthermia

Preferences

- Enjoys individual or group games, and drills where participants are paired
- Likes activities where the whole body is involved (e.g. jumping, running)
- Likes to assume some responsibility, and to take part in decisions relating to games or activities played
- Prefers activities that will allow him/her to shine and to be successful

To Avoid

- Activities that feature repeated impacts or where there is a risk of collision; repetitive activities (for reasons of boredom but also to prevent overuse injuries); activities that are too structured
- Mechanical and/or highly repetitive approach to the teaching of fundamental techniques; use of equipment that is not designed for children
- Repetition of all-out efforts lasting between 20 and 60 seconds; work against a high resistance; prolonged aerobic endurance efforts
- Exposure to a hot or cold environment (unless dressed appropriately for a cold environment)
- Specialization in a sport or for a position
- Emphasizing winning and creating a pressure to perform
- Comparisons with other children





- Negative competitive experiences
- Lengthy explanations
- Negative criticism

Suggestions

- Establish guidelines for acceptable behaviour, and act in a consistent and predictable manner; however, accept each child unconditionally
- Children need to be praised and complimented generously and regularly for their efforts; feedback must focus on one point only; choose the most important one; emphasize the following: development of confidence, self-esteem, peer interaction, cooperation, having fun, putting winning and losing into perspective, and giving a 100% effort
- Demonstrations must be highly specific, simple and aimed at the achievement of a well-defined objective; duration of activities must be relatively short, and exercises must change frequently
- Focus on activities that are aimed at developing coordination, balance and proper motor patterns; encourage participation in a variety of sports and activities; encourage the use of both right and left hands and feet whenever possible to enhance motor patterns and improve coordination; good age to use speed games
- Modified, scaled-down equipment should be used; competitive games where ability levels are matched; create opportunities for the child to demonstrate the progress he/she has made in a way that will enhance self-image; participants should have the opportunity to take some responsibility, and to assess the impact of such decisions; rules should be adapted to encourage a high degree of interaction between and involvement of participants, and to increase the probability of success during the activity
- Encourage children to drink water, and ensure that plenty of beverages are available when exercising in the heat





2.4 CCC Athlete Development Grid

LTAD STAGE	COACH LEVEL	FACILITIES	TECHNIQUE	PHYSIOLOGY	STRENGTH & FLEXIBILITY	MENTAL SKILLS	COMPETITION	OTHER
<p>“FUNDamentals” stage of athlete development.</p> <p>Boys and Girls 6 - 7 (first part of the FUNDamentals stage)</p>	<p>NCCP Community Coach (i.e. completed NCCP Community Coaching (CC) workshop)</p> <p>Minimum 26 hrs. training.</p>	<p>Varied terrain, groomed tracks for skating and classic techniques.</p> <p>Daylodge in stadium area.</p> <p>Continue to make use of ski playgrounds/ terrain parks.</p> <p>Lit ski playground.</p>	<p>Master fundamental movement skills, develop overall motor skills.</p> <p>Acquire basic cross-country ski skills (both classic and skating techniques); equal use of techniques;</p> <p>develop downhill abilities.</p> <p>Focus on balance, agility and rhythm.</p> <p>Use “Snow Goals” to encourage time on snow. Good technique habits are developed through repeated practice.</p>	<p>Window of optimal trainability for speed 1 and flexibility development.</p> <p>Develop general fitness through participation in a variety of sports/ activities on a regular basis, year round.</p> <p>Utilize games to develop technique, speed, skills and fitness.</p>	<p>Introduce basic flexibility exercises.</p> <p>Introduce strength exercises using the child’s own body weight, medicine balls, Swiss balls.</p>	<p>Create awareness of the importance of mental skills.</p> <p>Exposure to positive thinking skills to build confidence and the ability to cope with stress.</p> <p>Integrated mental, cognitive and emotional development.</p>	<p>Ski tournaments, club relays, treasure hunts, year-end activities.</p> <p>5 - 10 min. (0.5 to 1 km)</p> <p>4 races/ season. Use varied terrain, include some unconventional settings (e.g. obstacle courses, terrain parks).</p> <p>Introduce competition in a team environment whenever possible.</p>	<p>Ensure appropriate ski equipment including waxable skis.</p> <p>Practice sessions: two per/wk, minimum 16 on-snow sessions 60 min. organized activity plus supervised active ski play.</p> <p>Practice sessions should be well-structured and monitored.</p> <p>Time on skis in addition to practice sessions - as many ski playground experiences as possible (several times a week).</p> <p>Basic ski care.</p>





LTAD STAGE	COACH LEVEL	FACILITIES	TECHNIQUE	PHYSIOLOGY	STRENGTH & FLEXIBILITY	MENTAL SKILLS	COMPETITION	OTHER
<p>"Fundamentals" stage of athlete development. Boys and Girls 8 years (girls) and 8-9 years (boys) - second step in the Fundamentals stage</p>	<p>NCCP Community Coach (i.e. completed NCCP Community Coaching (CC) workshop) Minimum 26 hrs. training.</p>	<p>Varied terrain, groomed tracks for skating and classic techniques. Daylodge in stadium area. Continue to make use of ski playgrounds/ terrain parks. Lit ski playground.</p>	<p>Master fundamental movement skills, develop overall motor skills. Acquire basic cross- country ski skills (both classic and skating techniques); equal use of techniques; develop downhill abilities. Focus on balance, agility and rhythm. Use "Snow Goals" to encourage time on snow. Good technique habits are developed through repeated practice.</p>	<p>Develop linear, lateral and multi- directional speed with the duration of repetitions less than five seconds. Avoid anaerobic (capacity and power) efforts (i.e. 30-90 sec at highest intensity).</p>	<p>Introduce basic flexibility exercises. Introduce strength exercises using the child's own body weight, medicine balls, Swiss balls.</p>	<p>Create awareness of the importance of mental skills. Exposure to positive thinking skills to build confidence and the ability to cope with stress. Integrated mental, cognitive and emotional development.</p>	<p>Ski tournaments, club relays, treasure hunts, year-end activities. 4-6 races/ season Distance: 0.5 to 1 km (5 - 10 min.) Sprints: 100-200 m (skills race) Introduce competition in a team environment whenever possible. Adapt race distances to time guidelines for the stage of development. No racing below -15°C.</p>	<p>Ensure appropriate ski equipment including waxable skis. Practice sessions: two per/wk, minimum 30 on- snow sessions, 90 min. organized activity plus supervised active ski play, 10 pre-ski season/ classroom sessions. Practice sessions should be well- structured and monitored. Time on skis in addition to practice sessions - as many ski playground experiences as possible (several times a week). Basic ski care. Encourage inter- club social, skill and fitness-oriented ski activities (e.g. camps) during the ski season. Develop a team/ social atmosphere.</p>





2.5 Trainability

Trainability has been defined as the responsiveness of developing individuals at different stages of growth and maturation to the training stimulus. Although all systems are always trainable, some periods of growth and development provide windows of enhanced trainability.

Figure 2.5: Pacific Sport Windows of Optimal Trainability (adapted from Balyi and Way, 2005)

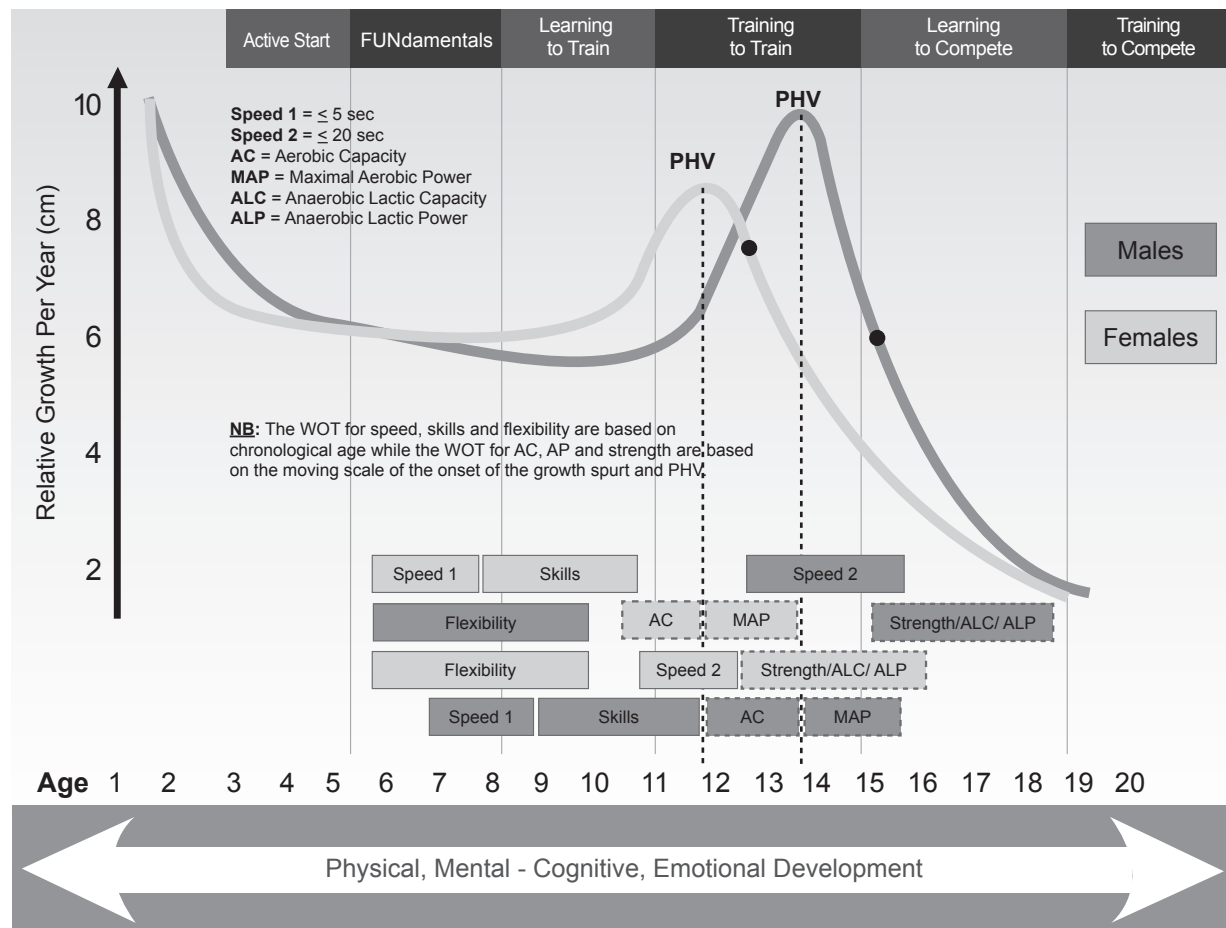

The five Basic S's of training are: stamina (endurance), strength, speed, skill and suppleness (flexibility). Of those five, three have windows of optimal trainability that are relevant to children in the FUNdamentals stage of development:

- ❑ **Skill.** Provide the base requirements for future advances in movement capacity. The window for optimal skill training begins late in the FUNdamentals stage of development (nine years of age for boys and 8 years of age for girls). This window ends at the onset of the growth spurt.
- ❑ **Speed.** Window of optimal trainability (Speed 1) for girls, and also for boys at the end of this stage. Develop linear, lateral and multi-directional speed with repetitions of duration of less than five seconds. For more information refer to section 4.3 of the CCI Learning to Train (Dryland) Reference Material.





- ❑ **Suppleness (Flexibility).** Basic static and dynamic flexibility/stretching exercises should be introduced in an appropriate setting, with an emphasis on proper technique. Development can occur through participation in a variety of off-snow activities. The window of optimal trainability for suppleness in both boys and girls occurs between six and 10 years of age. For more information refer to section 4.2 of the CCI Learning to Train (Dryland) Reference Material.

There is evidence that supports the fact that there is a high degree of variation in the trainability of children, both from the standpoint of magnitude of change and the time course of response to a given stimulus. This diversity must be taken into consideration when teaching skills to children.





REFERENCES

Cross Country Canada, *Cross-Country Skiing, A Sport For Life*, 2007.

Canadian Sport Centres, *Developing Physical Literacy*, 2007.

Detailed Growth and Development Considerations:

Bar-Or, O. (Editor) *The Encyclopedia of Sports Medicine: The Child and the Adolescent Athlete* (IOC Medical Commission Publication), Blackwell Scientific Publishers, Oxford, 1996.

Coaching Association of Canada, *NCCP Level 1 Coaching Theory manual*, Ottawa, 1989.

Coaching Association of Canada, Task 16: *Athlete Long-Term Development*, NCCP Level 4/5, Ottawa, 1994.

Coaching Association of Canada, *Straight Talk about Children and Sport*, Ottawa, 1996.

Malina, R., Bouchard, C., *Growth and Development of Children*, Human Kinetics, Champaign, 1991.



SECTION 3 - VALUES AND ETHICS IN COACHING



Coaching Tip: “Sports are wonderful; they can bring you comfort and pleasure for the rest of your life. Sports can teach you so much about yourself, your emotions and character, how to be resolute in moments of crisis and how to fight back from the brink of defeat. In this respect, the lessons of sport cannot be duplicated easily.”

Arthur Ashe



This section on Values and Ethics in Coaching expands on the information outlined in section 1 of the Introduction to Community Coaching Reference Material and will assist you in your role working with athletes at all stages of development.

3.1 Introduction to Making Ethical Decisions

As a coach, you will deal with a wide range of issues. Depending on the type of issues you encounter, you may experience a variety of emotions and thoughts.

Sometimes, you may feel that an action or behaviour is wrong. At other times, you may suspect or even know that a particular behaviour is illegal. In other instances, you may feel unsure about a situation and a decision, since there seem to be a number of acceptable alternatives. If you ask yourself this type of question, the issue probably has ethical implications.

A conversation with the person(s) involved is often all that's needed to deal with the situation. However, at other times this is not enough, and you may have to make a more formal intervention or refer the matter to another level of authority.

3.1.1 Values and Ethics: What Are They?

Our values represent a set of deeply held beliefs upon which our thoughts and actions are based. We refer to our values in evaluating our own actions, as well as the actions and decisions of others. In coaching, our core values are expressed as a series of principles defined by the *NCCP Code of Ethics*. A code of ethics defines what is considered good and right behaviour.

Ethical issues arise when our values and the corresponding ethical principles are compromised in some way. When this happens, the decisions are often sensitive and difficult to make. In these situations, the quality of the decisions a coach makes depends on a number of factors. These include the following:

- An understanding of the facts of the situation.
- An awareness of his/her own values and of the various factors that can influence his/her decision.
- The use of appropriate benchmarks to analyse the situation and understand what is involved.
- The ability to apply a rigorous decision-making framework to the situation at hand.

This module deals with each of these factors as part of an ethical decision-making process.

3.1.2 The Ethical Decision-Making Process

This module introduces a process that will enable you to make thoughtful and responsible decisions in situations presenting ethical or moral dilemmas. The process has six steps which are:





Step 1: Establish the Facts in a Situation. When faced with any situation or problem in coaching, you must establish exactly what has happened (or is happening) and who is involved in the situation before trying to figure out what to do about it.

Step 2: Determine Whether the Situation Involves Legal or Ethical Issues. Once the facts have been clearly established, the next step consists of determining whether the situation has legal implications. Two useful questions to ask yourself at this stage are:

- Has anyone been harmed by the action or decision of another, and if so, in what way?
- Does the action or the situation contravene an existing law?

Step 3: Identify Your Options and Possible Consequences. This step of the decision making process involves identifying your options for decision or action.

Step 4: Evaluate Your Options. Once you've identified your options and their possible consequences, you need to evaluate them, i.e. assess the pros and cons of each against a common reference point: the values of the NCCP Code of Ethics. This is a critical step in reaching a decision.

Step 5: Choose the Best Option. This is a crucial phase in the process, i.e. the one where a *decision must be made*. Steps 1 through 3 of the process provided you with objective information based on issues at play, options for decisions, and potential consequences. In Step 4, you analyzed the various options using a common reference point. Making an ethical decision now requires a final reflection on what is the best decision under the circumstances – a just and reasonable decision that will apply where an ethical dilemma is involved.

Step 6: Implement Your Decision. In Steps 1 to 5, you go through a reflection process that makes it possible for you to make a just and reasonable decision in response to an ethical situation. The final step in the ethical decision-making process is to implement your decision.

If you follow the above ethical decision-making process, you will:

- have a thorough process for making sensitive decisions;
- have solid arguments to justify your decisions from an ethical point of view; and
- feel confident you can assume the consequences of your decisions, knowing that it was the right thing to do under the circumstances.





3.2 Examples of Coaching Situations That Have Ethical Implications

Playing Time

At an early season meeting with players and parents, you indicated that your philosophy is to give each member of the team equal playing time – whatever the state of the game – as long as they are attending practices and are giving their best effort. Your most skilled player has just missed the last three practices because of family holidays. A less skilled player who plays in the same position has been at all practices. Both the players and their parents are waiting for you to decide who will be in the starting line-up, and how much playing time each player will get.

Some Issues in This Situation

- Living up to your word, consistency between intentions and actions.
- Consequences of demonstrating your values in action.
- Victory versus values.
- Leadership.
- Pressure from other players and from parents to play to win.
- Emotions/reactions of the players concerned.
- Perception of unfairness or fairness by the parents and players.
- Registration fee paid by all players.
- Whether practices missed because of family vacations are considered missed practices.



Some Possible Interventions by the Coach

- Consider family vacation as out of the child's control and play all participants equally.
- Play the more skilled participant for a greater percentage of time.
- Sit out the participant that missed the practices, and make no exceptions to the missed practice policy.
- Call a team meeting.
- Address only the participants and parents involved.

Note: Before following through on a chosen action, be sure that your intervention is consistent with the NCCP Code of Ethics and with fair play concepts.





Shaking Hands

After each competition, you have the participants on your team shake hands with their opponents. After a tough competition, one of your participants refuses to shake hands, on the grounds that some of the opponents mistreated him/her. The participant's parents seem to support this position, and encourage him/her to leave for home immediately.

Some Issues in This Situation

- Respect for team rules.
- Respect for the opponent.
- Fair play.
- Leadership of the coach versus influence of the parents.
- Parents as models for children.
- Confusion on the part of the participant about whose directions to follow.
- Authority of parents versus authority of the coach.
- Values of parents versus values of the coach.
- Breach of team contract.



Some Possible Interventions by the Coach

- Do nothing; the decision is the responsibility of the parents.
- Look around to see if anyone has noticed the situation and, if so, what seems to be their position?
- Intervene and insist that the participant shakes hands with the opponents.
- Do nothing at the time, but speak in private with the parents and the participant at a later time.
- Do nothing at the time, but speak in private to the parents at a later time.
- Do nothing at the moment, but speak in private to the participant at a later time.
- Hold a brief meeting with the parents and members of the team to re-emphasize the importance of shaking hands as a means of demonstrating fair play and honouring the team contract.

Note: Before following through on a chosen action, be sure that your intervention is consistent with the NCCP Code of Ethics and with fair play concepts.





Loud Mouth Fans

You are a coach of young participants and at a parent meeting a few days before a weekend competition one of the parents tells you he/she is not happy about the behaviour of some other parents. "Some parents on our team keep shouting directions to their child and to other kids on the team. They also harass kids and coaches on the other teams. I don't feel this is right at all," he/she says.

Some Issues in This Situation

- Quality of the competitive environment, and of the sport experience.
- Leadership of the coach.
- Image presented by those associated with the team.
- Respect for others.
- Self-control of parents in situations where there is an emotional involvement.
- Self-control in public.
- Parents as models of proper behaviour for children.
- Safety of the environment (verbal harassment, verbal abuse).
- Freedom of expression.
- Potential escalation (general security on the premises if parents come to blows).
- Potential to lose volunteers if the situation persists (coaches, other parents).
- The participant may be confused – Who should he/she be listening to: the parents or the coaches?



Some Possible Interventions by the Coach

- Talk with the parent who is voicing concern, but do not intervene with the other because you do not feel there is a problem (this is just a case of two parents who do not like each other).
- Intervene alone with the parent who is yelling.
- Intervene with all parents as a group.
- Intervene by requesting a meeting with the parent who is complaining, the parent who is yelling, and yourself as mediator.
- Have your team prepare a parent code of conduct and have a group of parents responsible for enforcing it.





- Talk to the participants about ignoring the yelling from the stands – they should only concern themselves with coaches, other players and the officials.
- Have the noisy parent banned from the stands.

Note: Before following through on a chosen action, be sure that your intervention is consistent with the NCCP Code of Ethics and with fair play concepts.

The Inclusive Team

A participant who has a mental disability has registered for your team. Parents of another child tell you they feel that a participant with a mental disability should not be allowed on the team because the program will be watered down and their own child's needs will not be met. Other parents hear the remark and are awaiting your response.

Some Issues in This Situation

- Respect for others.
- Parents as models for children.
- Inclusion.
- Quality of the sport environment.
- Potential to lose participants and parents.



Some Possible Interventions by the Coach

- Talk with the parent who is expressing concern.
- Intervene by having a meeting with all the parents.
- Have a team meeting with all the participants.
- Do nothing.
- Educate the complaining parent about inclusion in community sport.

Note: Before following through on a chosen action, be sure that your intervention is consistent with the NCCP Code of Ethics and with fair play concepts.





The Ignorant Coach

You are a coach of young male participants, and your team is from an ethnically diverse neighbourhood. One of the participants is physically disabled. After a league competition that you win, both teams are doing their cool-down close to each other. The other team's coach says to his/her assistant coach, at a volume that all can hear, "I can't believe we just lost to a team made up of foreigners and cripples. We played like a big bunch of girls." You can't believe what you, your team and the parents watching have just heard and you are fuming.

Some Issues in This Situation

- Discrimination.
- Safety of the environment (verbal harassment, verbal abuse).
- Respect for others.
- Parents/coaches as models of proper behaviour for children.
- Freedom of expression.
- Potential escalation (general security on the premises if parents/coaches come to blows).
- Leadership of the coach.
- Image presented by those associated with the team.
- Self-control in situations where there is an emotional involvement.
- Self-control in public.



Some Possible Interventions by the Coach

- Do nothing; pretend that you missed the comment entirely.
- Tell your team and parents to pay no attention to the comments.
- Tell the coach who made the comment that what he/she said is out of line.
- Intervene privately with the coach and address issues of respect and a safe environment for all.
- Intervene publicly with the coach and address issues of respect and a safe environment for all.
- Address your team and parents, indicating your displeasure with what you heard.

Note: Before following through on a chosen action, be sure that your intervention is consistent with the NCCP Code of Ethics and with fair play concepts





3.2.1 What Influences How You See?

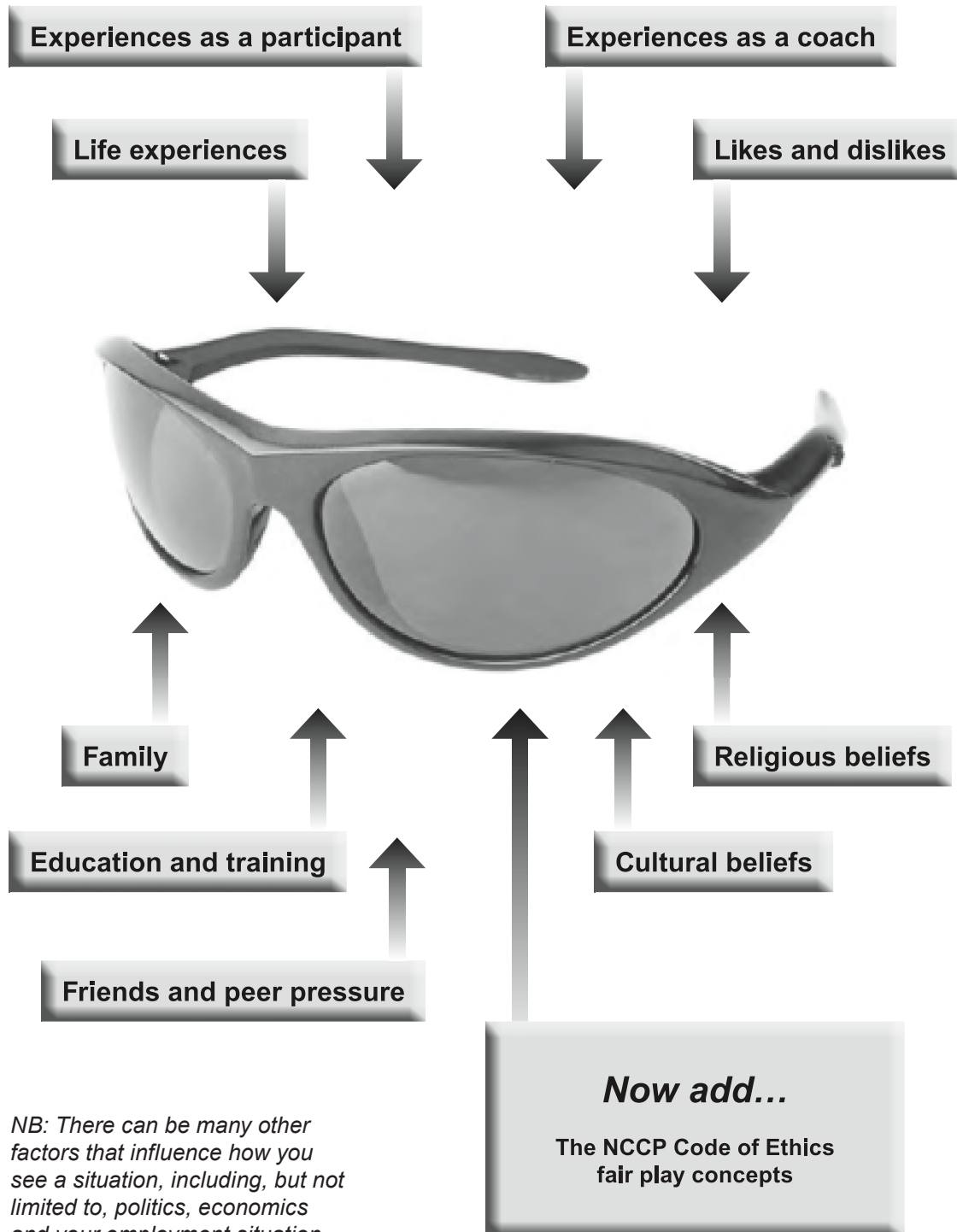

NB: There can be many other factors that influence how you see a situation, including, but not limited to, politics, economics and your employment situation if you are a paid coach.





3.3 NCCP Code of Ethics

What is a Code of Ethics?

A code of ethics defines what is considered good and right behaviour. It reflects the values held by a group. These values are usually organized into a series of core principles that contain standards of behaviour expected of members while they perform their duties. It can also be used as a benchmark to assess whether certain behaviours are acceptable.

Why a Code of Ethics in Coaching?

Core coaching values have been formalized and expressed as a series of principles in the NCCP Code of Ethics. These principles can be thought of as a set of behavioural expectations regarding participation in sport, coaching athletes or teams, and administering sports.

The NCCP Code of Ethics can help coaches to evaluate issues arising within sport because it represents a reference for what constitutes both “the good and right thing to do”. For example, the code of ethics helps coaches make balanced decisions about achieving personal or team goals and the means by which these goals are attained.

Values Underpinning the NCCP Code of Ethics

The NCCP Code of Ethics is a simplified version of the Code of Ethics of Coaches of Canada (formerly the Canadian Professional Coaches Association). However, both codes deal with the same fundamental values of safety, responsible coaching, engaging in relations with integrity, respecting athletes, and honouring sport. These values are expressed as 5 core ethical principles.

- Physical safety and health of athletes.
- Coaching responsibly.
- Integrity in relations with others.
- Respect of athletes.
- Honouring sport.

The following chart provides a description of each principle and outlines some implications for coaches.





3.3.1 Ethical Principles and Their Corresponding Behaviours/Expectations

Principle	Standards of Behaviour Expected of Coaches
Physical safety and health of athletes	Ensure that training or competition site is safe at all times
	Be prepared to act quickly and appropriately in case of emergency
	Avoid placing athletes in situations presenting unnecessary risk or that are beyond their level
	Strive to preserve the present and future health and well-being of athletes
Coaching responsibly	Make wise use of the authority of the position and make decisions in the interest of athletes
	Foster self-esteem among athletes
	Avoid deriving personal advantage for a situation or decision
	Know one's limitations in terms of knowledge and skills when making decisions, giving instructions or taking action
	Honour commitments, word given, and agreed objectives
	Maintain confidentiality and privacy of personal information and use it appropriately
Integrity in relations with others	Avoid situations that may affect objectivity or impartiality of coaching duties
	Abstain from all behaviours considered to be harassment or inappropriate relations with an athlete
	Always ensure decisions are taken equitably
Respect	Ensure that everyone is treated equally, regardless of athletic potential, race, sex, language, religion, or age
	Preserve the dignity of each person in interacting with others
	Respect the principles, rules, and policies in force
Honouring sport	Strictly observe and ensure observance of all regulations
	Aim to compete fairly
	Maintain dignity in all circumstances and exercise self-control
	Respect officials and accept their decisions without questioning their integrity





3.4 A Simplified Ethical Decision-Making Framework

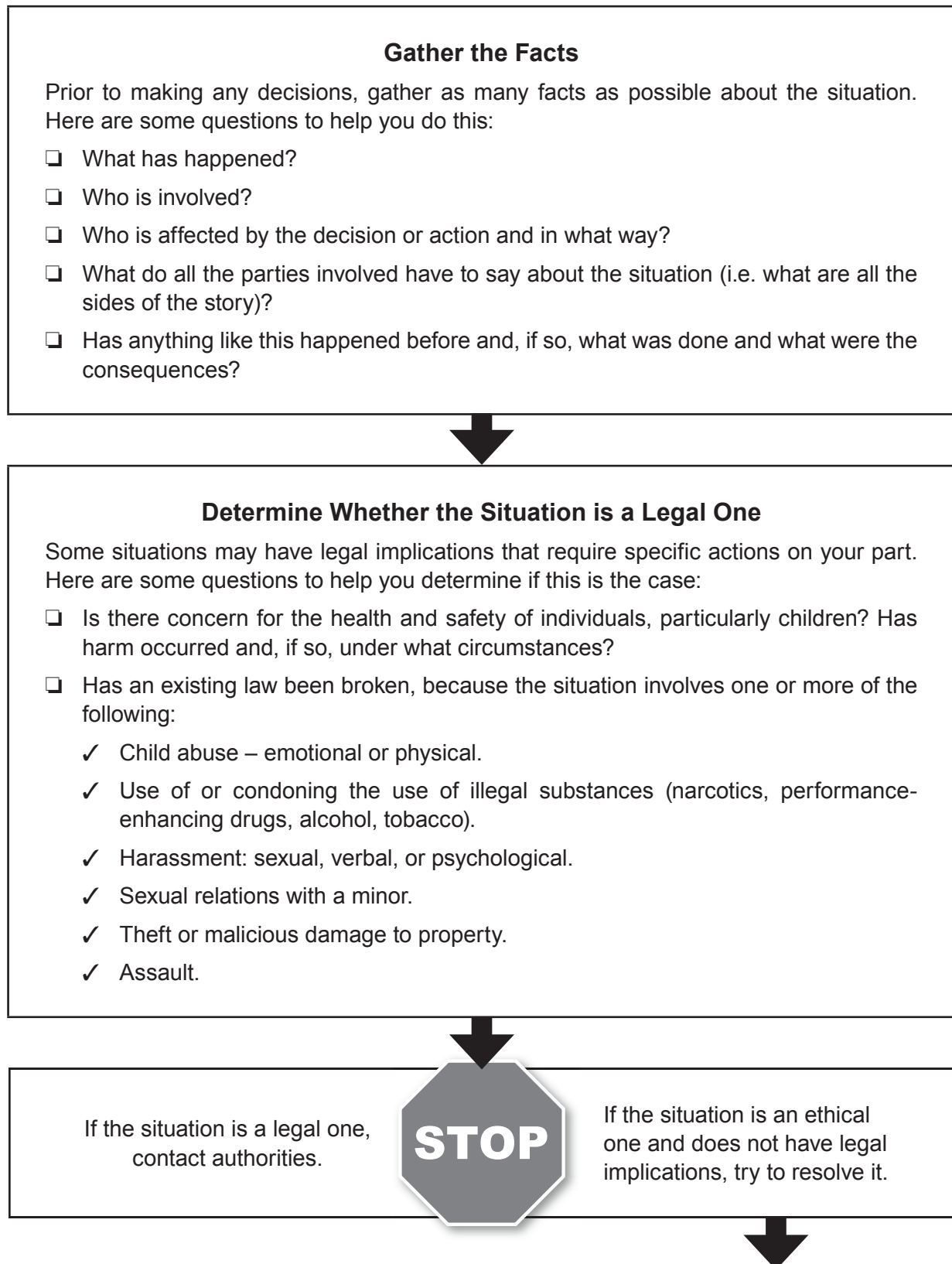



Identify All the Ethical Issues

Here are some questions to help you clearly identify all the issues that are at play:

Outcomes

- ✓ Did the actions of an individual or group prevent an individual or group from reaching a goal?
- ✓ Did certain actions or non-actions result in harm to anyone?

Means

- ✓ Was the issue related to the way someone did something?
- ✓ Are there guidelines that indicate how a similar situation should be addressed?

Rules and Laws

- ✓ Have specific rules or laws (of the game) been broken?
- ✓ Have team policies been violated?
- ✓ Have specific rules or laws been misinterpreted (accidentally or deliberately)?
- ✓ Does the rule or law need to be changed?

Responsibilities and Duties

- ✓ What duties and responsibilities did the parties involved have toward each other?
- ✓ Has an individual or individuals failed to fulfil duties or responsibilities?



Consider What Might Influence How You See the Situation

Some factors that may influence you are outlined on section 3.2.1.



Use the NCCP Code of Ethics to Guide Your Choice of Action

Here are some questions to consider as you are choosing what you are going to do:

- Is it possible to park the situation until emotions cool?
- If appropriate, can you resolve the situation in an informal way?
- Can/should others be involved in the decision?





3.5 Community Sport as a Discrimination-Free Zone

Every individual is equal before and under the law and has the right to the equal protection and equal benefit of the law without discrimination and, in particular, without discrimination based on race, national or ethnic origin, colour, religion, sex, age or mental or physical disability.

Canadian Charter of Rights and Freedoms

One of your shared responsibilities with participants and parents is to ensure that discriminatory behaviour on the basis described in the charter and in the NCCP Code Of Ethics is not tolerated in your sport environment.

- Discrimination** occurs when an individual or group is treated unfavourably or unequally because of *prejudice* or *stereotyping*.
- Prejudice** is the use of prejudgment, or having a preconceived opinion about someone.
- A **stereotype** is the broad, often inaccurate, belief about the characteristics of a cultural, ethnic or racial group used to describe an individual thought to be a member of that group.
- Harassment** is comments or conduct that should reasonably be known to be unwelcome to another, and can include actions such as jokes that isolate a particular group or groups, verbal slurs and insults, and condescending or intimidating behaviours.

What can I do to create a discrimination-free zone with my group or team?

There are many influences on participants that affect their ability to treat each other fairly and with respect. For example, the participants may have been exposed to racist or sexist behaviour all around them at school, at home or at play. The best thing you can do as a coach is to watch what you say and do, to intervene if someone on or around your team acts in a discriminatory way, and to encourage the participants and their parents to intervene themselves if they see or hear this type of behaviour.

Addressing how participants want to be treated and how they are going to treat others is a great starting point for building a team code together, which will go a long way toward preventing discriminatory behaviour before it happens.

What Can I Do If I Witness Discriminatory Behaviour?

Understand clearly that not responding is actually interpreted by others as a response; this passive response can indicate that you are OK with what was said or done. A passive response, although leaving you at little personal risk, does nothing to change or stop the behaviour from happening again.





An aggressive response usually seeks to shame the person who has shown the discriminatory behaviour. This type of response usually escalates the situation and does not model respect for others.

Choose a Positive Response to Intervene Effectively!

<p>Passive Response (doing nothing)</p> <p>Not recommended</p>	<ul style="list-style-type: none"> • The goal is to ignore the behaviour. • Sometimes an attempt is made to rationalize the behaviour. • This assumes the other person will not stop/change the behaviour if an intervention is made. • Considers time on task and/or personal safety as more important. <p>Examples: Laughing along with a discriminatory joke, or saying nothing when a discriminatory remark is made.</p>
<p>Aggressive Response (confronting)</p> <p>Not recommended</p>	<ul style="list-style-type: none"> • The goal is to stop the behaviour in the short term. • Comes across as judging the person, not the behaviour. • Usually results in the other person wanting to retaliate. • Often based on a sense of superior authority, strength or numbers. • The safety of the person whom you are confronting is now also at risk. <p>Examples: “I can’t believe you said that. How ignorant can you be?” “Don’t you know that what you are saying is wrong?”</p>
<p>Positive Response (seeking change)</p> <p>Recommended</p>	<ul style="list-style-type: none"> • The goal is to stop the behaviour in the short term and to change the behaviour in the long term. • Names the behaviour as unacceptable. • Points out what is needed in the situation. • Does not judge the other person. • Is based on modeling respect. <p>Example: “Please do not say that; it is hurtful. How about treating that person as you would like to be treated, and as we agreed to treat one another as team members?”</p>





By choosing a positive response and intervening when you witness discriminatory behaviour, you are modeling respect for others, and attempting to educate for change.

What is Inclusion?

Inclusion means welcoming and providing full access to teams and programs for participants from under-represented groups and persons with a disability in your community.

Inclusiveness is a value that is the opposite of discrimination. It is manifest in programming that encourages the active involvement of participants from all segments of society in all aspects of a team or sport activity. It does not mean that the focus of the team or sport program should be on under-represented groups or athletes with a disability, but rather that they should have access to the mainstream sport system and play just as integral a role as any member of the team or program.

A Checklist - Is Our Team Environment a Discrimination-Free Zone?



- People-first language is used (i.e. language that does not demean a particular person or group).
- Posters and other materials that demean a particular group are not displayed or exchanged (e.g. posters, cards, magazines, cartoons, videos/DVDs, screen-savers).
- Name calling is not tolerated.
- Jokes that poke fun at specific populations are not tolerated.
- Every participant is given equitable coach attention.
- Every participant is given equitable playing time in community sport.
- Every participant has a say in developing the team code of conduct.
- The team code of conduct outlines behaviours that will promote a discrimination-free zone and this code is enforced by all.
- Initiation ceremonies are not practiced.





3.6 A Participant-Centred Environment

“Give a person a fish and you will feed him/her for a day; teach a person to fish and you will feed him/her for a lifetime.”

What is a Participant-Centred Environment?

A participant-centred environment in sport means that the coach actively seeks to build conditions in which the participants can develop as whole and independent persons, capable of making decisions and choices regarding their learning and experiences in sport. The process can begin once the coach fully understands the growth and development stage of the participants.

In contrast, a coach-centred environment is one in which all decisions and feedback originate from the coach and are imposed on the participants. Participants who develop in a coach-centred environment tend to be more dependent on their coach and less able to function well when their coach is not at their side all of the time.

In a participant-centred environment, participants who are taught over time to take control of their learning and progress learn to become dependent upon themselves; they also develop the ability to identify their needs and to seek out help when required. Many more variables are therefore within the participant's control and, as a consequence, the participant generally performs better in group situations or in competition with or without the presence of the coach and is more likely to take responsibility for both successes and failures. You play a key role in setting the foundation for participants' development as sport learners and as athletes, should they choose to continue in the sport.

There is no doubt that, as an adult who is coaching children, you are responsible for the safety and the structure of the learning environment. Children depend on the coach to establish with them and to maintain consistent guidelines for what is acceptable behaviour in their sport learning environment. Involving participants in the process makes each child feel valued and safe to take risks and grow.

Participant-centred coaching does not mean that the coach is not responsible for planning practices, establishing a structure and framework for each practice or sharing expertise during practices. It simply means that the coach should:

- allow for choice in what is to be done and how it is to be done;
- encourage input from participants;
- allow time for participants to explore several options and come to understand for themselves why some options are more effective than others; and
- value and respond to each participant's input.

Participant-centred coaching often requires more planning on your part than a practice in which





you are in full control of what the participants do and how they do it.

What Does a Participant-Centred Environment Look Like?

Novices in any activity rely on direct coaching input to get them started. Coaches often make the mistake of maintaining the same approach as development progresses, even when the participants are more able to give feedback on their needs. Participant-centered coaching means sharing the responsibility for learning with the participant; it is about coaching for empowerment, not coaching to be in power.

A Participant-Centred Environment	A Coach-Centred Environment
There is a clear structure and organization to what is going on; everyone is on task.	Free-play with everyone doing what they want or coach dictates who goes where and does what at all times.
Participants are involved in the decision-making (rules of an activity, ideas for activities, groupings, movement between stations).	The coach decides what is going to be done, when it will be done, who will do it, and for how long.
All participants are active and engaged in a task, because stations are set up and running simultaneously.	Participants do a lot of waiting in line as the whole group does a single drill.
Parents and/or assistants are involved in the practice as facilitators (if you set up stations to maximize active time, then you will need help with them).	The coach is the only one managing the activities; practice is drill oriented rather than activity oriented; parent involvement is discouraged.
Direction is given only when there is a need for information (instructions on getting started or how to perform a task – skill, activity, explaining rules of a game).	The coach talks a lot and constantly gives orders.
Feedback starts with questioning the participants (guided discovery – participants are prompted rather than told).	Feedback starts with the coach telling a participant what to do differently in order to correct mistakes.





Participants control the pace of learning, so that if more practice time is needed, it is available; participants move on to a higher challenge when they are ready.	The entire group constantly shifts from one activity to the next, with little attention paid to what was learned or if it was learned or a single activity is done repetitively to the point of boredom.
Participants try things out, are not afraid of failure, and ask for the coach's help when needed. They seek help not from a position of dependency but on their own terms.	Participants look to the coach all the time to "teach me".
Participants play mini games or a version of the game that is adapted for their stage of development.	The adult game is played by the participants.

What Are the Effects of a Participant-Centred Environment?

Participant-centred coaching not only builds the skills of the sport in participants, but it also teaches them life skills such as problem-solving, self-direction, ownership and responsibility of their actions and their learning, and creativity.

A Participant-Centred Environment Results in Participants Who:	A Coach-Centred Environment Results in Participants Who:
Are able to make decisions on the playing field at critical moments.	Hesitate and have difficulty reading a situation on the fly.
Are eager to be challenged (want the ball in the decisive moment) and free to take risks – failure is OK and accepted as a stimulus to learning.	Don't want to be challenged too much (they fear failure, and do not want to be on the field at critical times).
Are able to clearly state their needs and do not fear assistance.	Cannot state clearly what they need (because they may have no training in identifying their needs).





Are able to take responsibility for their mistakes.	Blame or deflect responsibility (because they really have no control over the situation so it can't be their fault).
Are able to change their response after a mistake.	Are locked into prescribed responses and so have limited ability to recover from mistakes and adapt future responses.
Can manage on their own if the coach is unable to attend a competition.	Have difficulty making decisions without input from the coach.
Are aware of their emotions and therefore are able to learn to control them – they don't feel locked into their prescribed response.	Are overwhelmed by the emotions they feel they have no control over and therefore cannot change.
Are open to creative responses and new ideas when situations change.	Can respond appropriately only if the situation in competition is exactly as it is practised; however, if the situation changes in any way, they cannot adapt.

How Do I Build a Participant-Centred Environment?

It takes time to build this kind of environment. Initially, participants will be looking for the coach to give them permission to think freely. Once you allow this to happen, they will soon take ownership of their learning.

- ❑ **Set the Scene.** At the beginning of the season, hold a parent meeting at which you will explain this type of philosophy in practice. Request parent help to accomplish this. Gather the following:
 - ✓ Sample practice plans to help you get started in coaching.
 - ✓ Games/activities to develop basic skills in a variety of ways.
 - ✓ Teaching aids and equipment – in addition to sport equipment, you will need clipboards.
 - ✓ Parent volunteers, assistants.





- ❑ **Set Practice Goals with the Participants.** Use the cool-down and wrap-up of one practice to ask for participant input on the goals for the next practice (participant generated, coach guided). Some sample questions you can ask include:
 - ✓ What worked best?
 - ✓ Why did that work?
 - ✓ What didn't work so well?
 - ✓ Why didn't it work?
 - ✓ What would you like to learn next practice?
 - ✓ Can we do this or do we need to learn something else first?
 - ✓ What do you think we could do to help us learn this?

- ❑ **Set the Environment**
 - ✓ Set up learning stations where participants can explore and challenge themselves at different levels.
 - ✓ Use activities and mini games instead of repetitive drills.
 - ✓ Challenge participants to develop their own games that can help develop a skill.
 - ✓ Whenever possible, be sure to have sufficient equipment for participants to play with without having to wait their turn.

- ❑ **Prompt Participants to Think for Themselves.** Instead of telling, ask lead questions:
 - ✓ Did you accomplish your goal with efficiency (e.g. get from point A to point B as quickly as possible)?
 - ✓ Did you get the desired result?
 - ✓ Are there other ways to do the same thing?
 - ✓ Can you try some other options? Which one works best for this situation?
 - ✓ What could you do now to get better in this situation?
 - ✓ Do you need to continue trying the activity or is it better to change the activity?





3.7 Sport and Self-Esteem

What is Self-Esteem?

Self-esteem is an outcome of how positively an individual feels about himself/herself. A person's self-esteem can be directly affected by the positive and negative comments of others toward him/her, including those received during participation in sport.

The Importance of Self-Esteem in Sport

Sport gives participants the opportunity to acquire new abilities and to assess their skills in competition. Those participants that have high self-esteem tend to learn quicker and perform better than those with poor self-esteem. One of the most important phases of self-esteem development occurs between the ages of six and 11. Therefore, parents, coaches, and other adults who work directly with young participants play significant roles in helping them feel good about themselves.

Even remarks that seem insignificant to the person that made them may have an impact on a participant. Parents and coaches should always point out things that the participant is doing well, as well as those that need to be improved. Positive reinforcement can be given on how a participant is performing a skill/activity, and can also be provided for aspects of behavior that have little to do with performance in sport (e.g. following the rules, playing fair, being on time, taking good care of equipment, making others laugh or relax).

What you say matters a lot to the participants. Coaches can directly impact the self-esteem of the participants, and therefore must carefully assess the potential impact of the words they use and the comments they make on the participants before they are made.

Indicators of Low Self-Esteem in Children

The following behaviors may indicate that a child has low self-esteem:

- He/she avoids performing a task or accepting a challenge, or drops out after an initial error or poor performance.
- He/she cheats or lies in order to avoid losing a game, or to avoid being perceived as a poor performer.
- He/she shows signs of regression by acting immaturely for his/her age.
- He/she becomes uncompromising in order to hide a feeling of incompetence, frustration, or powerlessness.
- He/she finds excuses ("The coach is stupid") or diminishes the importance of the event ("I don't like this sport anyway").
- He/she marginalizes himself/herself by losing or reducing contact with his/her friends, or with others in general.





- He/she experiences mood swings, is sad, cries, and/or has temper tantrums, is frustrated, or is silent.
- He/she expresses negative comments about himself/herself (e.g. “I never do anything well,” “No one loves me,” “I’m ugly,” “It’s all my fault”).
- He/she has difficulty accepting compliments or criticism.
- He/she is excessively concerned about the opinions of others.
- He/she is highly influenced by his/her friends, even when the influence is very negative.
- He/she helps too much, or never helps at all.

Tips to Help Children Improve Their Self-Esteem

- Give them a warm and personal welcome when they arrive, and make sure they are happy to be there.
- Show them that you have confidence in their ability to learn and improve.
- Show respect for them.
- Tell them what their positive qualities are, and what they do well.
- Show them you appreciate them as persons.
- Communicate with them in a positive way.
- Design activities that are suited to their level of performance. Establish realistic goals and expectations based on their abilities.
- Give sincere and frequent praise, especially to young children. Encourage effort and avoid always focusing on results. However, avoid giving false praise, as participants will soon stop valuing your feedback.
- Avoid games involving an elimination process because they may create unnecessary pressure. Create situations with high chances for success.
- Be specific when you praise efforts or performance.
- Praise them for their special achievements; recognize the progress they make.
- Smile, wink, or nod when you want to express acknowledgment. A pat on the back or a “high five” is an excellent indication of support.
- Give them responsibilities. Involve them in the decision-making process and give everyone the opportunity to be a leader (e.g. alternate captains regularly).
- Ask for their opinions and encourage them to ask questions.





Tips to Help Children Develop Confidence and Self-Esteem in Various Sport Situations

❑ During a Selection

- ✓ Meet with each participant individually.
- ✓ Reaffirm the strengths of each participant.
- ✓ Offer improvement strategies.
- ✓ Respect everyone's dignity at all times.
- ✓ Contact all parents in order to provide answers to their questions.

❑ When Commenting or Providing Feedback About the Practice

- ✓ Make simple and specific suggestions.
- ✓ Have the participants take responsibility for their actions.
- ✓ Encourage the participants.
- ✓ Be enthusiastic and constructive.
- ✓ Avoid giving the impression that coaching is a burden - have fun!
- ✓ Be as specific and thorough with your positive comments as you are with your corrections.
- ✓ Actively seek their contribution and input.
- ✓ Respect their opinion.
- ✓ Be flexible regarding your positions and opinions.
- ✓ Value their participation.

❑ During a Pre-Competition Talk

- ✓ Avoid dramatization; have the participants focus on their actions, not on the final result.
- ✓ Be enthusiastic and constructive.
- ✓ Acknowledge their feelings, and listen to them.
- ✓ Remind them of the things they do well.
- ✓ Express the trust you have in them.

❑ After a Competition Win

- ✓ Always comment on the competition.
- ✓ Enjoy the victory.
- ✓ Emphasize what they did right.
- ✓ Discuss what can be improved.
- ✓ Acknowledge the efforts of the opponent.
- ✓ Refer to what lies ahead and how what was learned in this competition will contribute to future success.





□ After a Competition Loss

- ✓ Acknowledge their efforts.
- ✓ Identify things done well and the strong points of the performance.
- ✓ Let them know specifically what can be improved.
- ✓ Ensure that participants learn from the defeat.
- ✓ Remind participants that there will be other opportunities, and that what is important is giving their best effort.





3.7.1 Are the Children Having Fun?

While the children were participating, the following was observed:
(Tick once in the shape for each time it was observed)



A child smiled



A child laughed or giggled



A child encouraged another
(cheer, pat on back, high five)

YOUR SELF-ESTEEM METER (count your ticks)

***Today, your coaching helped make a child feel good about
himself/herself _____ times.***

Way to go!





3.8 How Parents Can Encourage Girls to Play Sport

☐ Photograph Your Child Being Active

- ✓ Enlarge the photo.
- ✓ Be proud of it.

☐ Actively Support Your Daughter's Involvement in Physical Activity

- ✓ Buy her good equipment – not her brother's hand-me-downs.
- ✓ Come and watch her games.
- ✓ Consider volunteering.
- ✓ Drive her to and from practice.
- ✓ Make sure your daughter has time in her life to be active – don't make your daughter sacrifice her involvement in sport so she can baby-sit or do housework.

☐ Take Your Daughter to the Park and be Active With Her

- ✓ Help her learn the fundamental skills of running, throwing, catching and kicking.
- ✓ Be an active role model.
- ✓ Mom's participation in sport increased participation rates of her child by 22%.
- ✓ Dad's participation in sport increased participation rates of his child by 11%.

☐ Emphasize Fun and Fitness Rather Than Competition and Slimness

- ✓ Encourage your daughter to try a variety of new activities, and help her acquire the skills and equipment she needs to participate.
- ✓ Avoid comments about your daughter's body size and shape. Love and support her just the way she is.
- ✓ Don't undermine her confidence and take the joy out of her playing by telling her "she throws like a girl". Help her to learn the skills she needs to enjoy sport.

☐ Introduce Your Daughter to Active Women. All too often women in sport are viewed as cheerleaders, water girls or chauffeurs. Your daughter needs to be exposed to women who are athletes, coaches, officials, and leaders in the sport:

- ✓ Buy sports books about women athletes.
- ✓ Watch women's sport events on TV with your daughter.
- ✓ Read the sport pages with her and ensure that she is aware of the performances of great Canadian athletes like Beckie Scott, Silken Laumann, Perdita Felicien, Catriona LeMay Doan, Myriam Bedard and Alison Sydor.

☐ Plan Active Vacations or Weekend Excursions

- ✓ Try hiking, cycling, rafting.





REFERENCES

CPCA Coaching Code of Ethics, Canadian Professional Coaches Association.

How Parents Can Encourage Girls to Play Sport. Promotion Plus.

Some images and pictures contained in this document are the property of CARDISPORT or HEMERA TECHNOLOGIES INC. and are copyrighted.

The Coaching Association of Canada expresses its thanks to the Aboriginal Sport Circle and Executive Director Rick Brant, the Canadian Association for the Advancement of Women and Sport and Physical Activity and acting Executive Director Karin Lofstrom, and the Special Olympics Canada Director of Coach Development Mary Bluechardt, for permission to adapt their materials on racism, equity, and inclusion.





SECTION 4 - TEACHING CLASSIC TECHNIQUE



Coaching Tip: If children practice a sport incorrectly, they are unable to change and adapt (later), and then they cannot move on. We must have coaches who can teach youngsters the right techniques from the beginning.

Source: Fennell



Teaching Cross-Country Skiing

Your success as a coach will depend in large part on your understanding of the principles of teaching, adapted to the group that you are coaching. Section 4 (Teaching Classic Technique), section 5 (Designing an Overall Plan for the Season) and section 9 (Teaching Skating Technique) of the Reference Material are intended to provide you with the information you will need to effectively teach ski technique to children in the FUNDamental stage of development. The table below highlights the resource material that will be of highest priority to you.

Essential Material

- 1. General Factors to Consider When Teaching Technique.** (Section 4.1) Information to help you understand the many factors that will influence your success in teaching technique, regardless of how well you teach it.
- 2. FUNDamentals Practice Plans – Levels 1 to 4.** (Section 5.3 to 5.6) A progression of comprehensive practice plans outlining what to do from the beginning of a practice session to the end of it, for every practice session in a season.
- 3. Ski Exercises for Developing Balance.** (Section 4.1.4) A selection of basic exercises that are age-appropriate and teach balance, agility and coordination. You can draw from this list as needed to modify the recommended practice plans.
- 4. Games for Teaching Technique.** (Section 4.3.9) A selection of games that are age-appropriate and teach balance, agility, coordination and ski technique. You can exchange games from the recommended practice plans if those games do not suit the snow conditions or available terrain, or simply incorporate them to your plan as needed to enhance your practice session.
- 5. FUNDamental Skill Criteria and Evaluation Benchmarks.** (Section 4.3) Tools that explain the technique standard expected for each of the four progressive levels/stages (coordinated with the four levels of practice plans).
- 6. FUNDamental Skill Checklists – Levels 1 to 4.** (Section 4.3) Tools to record the technical skills achieved at each progressive level/stage (coordinated with the four levels used for the practice plans and technique awards).
- 7. Progress Report.** (Section 4.3.12) An example of a report card that summarizes a child's progress at the end of each season.
- 8. Classic Technique Checklist.** (Section 4.2) Information to help you teach the classic techniques.
- 9. Skating Technique Checklist.** (Section 9.1) Information to help you teach the skating techniques.





4.1 General Factors to Consider When Teaching Technique

There are many factors that can influence a good learning environment for the acquisition of ski technique. Below are some of the key points that you should keep in mind when you are preparing to teach an on-snow practice session. You should also keep in mind that most of the factors or considerations need to be adapted to the age and skill level of the children you are coaching in order for you to achieve maximum effectiveness.

4.1.1 Checklist of Important Considerations

The following bullets highlight the key considerations that you must address as you prepare to teach children in the FUNDamental stage of athlete development how to ski. Where appropriate, the bullets direct you to the point in the Reference Material where you can find more information on the subject.

- Appropriate Clothing.** Refer to section 3 in your Introduction to Community Coaching Reference Material for more information.
- Appropriate Ski Equipment.** Refer to section 7 in this manual and section 3 in your Introduction to Community Coaching Reference Material for more information.
- Appropriately Prepared Skis.** Refer to section 7 in this manual and section 3 in your Introduction to Community Coaching Reference Material for more information.
- Appropriate Terrain/Setting.** Children will learn best at a kid-friendly ski area with a variety of terrain to choose from, adventure-based features such as obstacle courses and/or adventure trails, and a daylodge/shelter in close proximity to where the majority of their skiing takes place. Refer to section 4 in your Introduction to Community Coaching Reference Material for more information.
- Appropriate Grooming.** An appropriately packed and trackset ski area/trail is essential for learning technique.
- Good Coaching Methods and Technique Instruction.** Refer to section 4.2 of this reference material for information on teaching classic technique; section 9.1 on teaching skating technique; section 4.3 on teaching cross-country ski skills to children and section 5 on the delivery of effective practice sessions. Refer to sections 4 and 8 of the CCI Learning to Train (On-Snow) Reference Material for more advanced information on teaching skating, classic and downhill techniques.
- Use of Effective Role Models.** Refer to section 4.1.2 of this manual for more information.
- Use of Relevant Technology.** Refer to section 4.1.2 of this reference material for information on the use of video feedback for error detection and correction. Refer to section 3.3 of the CCI Learning to Train (On-Snow) Reference Material for more detailed information.
- Appropriate Use of Games.** Refer to sections 4.3.9 and sections 5.1 of this manual for more information.





- ❑ **Appropriate Level of Physical Fitness.** Skiers must be sufficiently fit to be able to participate in the program
- ❑ **Opportunity to Practice Skills between Practice Sessions.** Refer to section 4.1.3 of this manual for more information.

4.1.2 Role Models/Video Replay

Children like to imitate good technique. It looks fast, smooth and exciting to them. Therefore it is worth your time to recruit technically competent role models to ski with your group occasionally. Some suggestions are: (1) a technically competent skier in the age group just above the group you are working with (the children can identify with the age of the skier and their skills appear more achievable); (2) a successful junior athlete from your club or region; and/or (3) a senior/master skier they look up to. Children also respond well to learning technique from videos or DVDs, providing the footage is action-packed and fast moving.

Video replay, especially using cameras that feature frame-by-frame replay, is another effective teaching tool. It can be introduced during the FUNdamentals stage, as children love to watch themselves on camera, but it will be more effective with older skiers. If you do use video replay, it is preferable to do so on snow where the children have an opportunity to repeat a technique immediately after seeing themselves on the camera and receiving feedback, and where interaction with the coach is one-on-one, not in front of their peers.

4.1.3 Snow Play Goals

It is essential for children to have the opportunity for unstructured play-time on skis in addition to practice sessions if they are going to develop technical competence.

Although exposure to a variety of sports/activities is an important requirement of a child's physical development, coaches should keep in mind that the snow season is short in the context of year-round activity. Therefore, if children are going to develop competence in cross-country skiing, they may have to achieve it in a period as short as 10 to 12 weeks per year. This means that when snow is available, participation in cross-country skiing should be as frequent as four or five times per week, depending on the age of the skier. Generally speaking, children need to ski more than once a week to retain new skills, and four to five times a week if they wish to improve their skill level significantly.

Age	# Practice Sessions	# Play-time on Skis in Addition to Practice Sessions
6 years	16 on snow; 2 per week	minimum of 2x/wk over 3 months = 24
7 years	16 on snow; 2 per week	minimum of 2x/wk over 3 months = 24
8 years	30 on snow; 2 per week	minimum of 3x/wk over 3 months = 30
9 years	30 on snow; 2 per week	minimum of 3x/wk over 3 months = 30





For children six to nine years of age, the preferred setting for play-time on skis is a ski playground or terrain park. In addition to using a kid-friendly setting, coaches can improve the potential benefit from unstructured play-time on snow if they provide their skiers with some direction during the practice sessions. A well-prepared coach will give each child specific suggestions as to which skills to work on between sessions, and then follow up at the next practice.

To ensure play-time on skis is time well spent, the importance of kid-appropriate settings/activities and quality time on skis should be emphasized to parents, as they will have the most influence on their children's skill development outside of practice sessions. Parents should also be encouraged to coordinate transportation and ski playground supervision with other parents, and to give their children an opportunity to use head lamps if they live in a communities where a lit trail system is not accessible.

4.1.4 Ski Exercises

These activities are designed to improve the balance, agility, coordination, rhythm and confidence on skis that will establish the foundation on which ski technique skills can be developed.

The exercises are generally listed in order of difficulty. Some are appropriate for children under six while others are more suitable for older novice skiers. They are presented most effectively when interspersed throughout the practice session. When practising these exercises the skier should be stationary and without poles.

- ❑ **Soldiers.** At a command to stand at “attention”, the skiers stand tall with locked knees and straight backs. At a command to stand “at ease”, they relax their knees and let their upper body slouch.
- ❑ **Tippy Toes.** The skiers roll onto the balls of their feet until the heels of their feet are about to lift off the ground. They then roll onto their heels until their toes lift against the inside of their boots. Next they do the “Teeter-Totter”, rocking back and forth from the balls of their feet to their heels.
- ❑ **Reach for the Sky.** The skiers reach for the sky, first going up on their tiptoes, and then settling back on both feet at the same time.
- ❑ **Touch Your Tongue.** The skiers press their shins against the tongues of their ski boots, experimenting with the use of both slight and strong pressure as they squat down. This exercise teaches them the difference between a knee and an ankle bend. When skiers have mastered this activity, they can try it using one leg/ski at a time.
- ❑ **Flea Leaps.** The skiers jump into the air (on their skis) and land softly in a balanced position.
- ❑ **The Stork Stance.** The skiers practice standing on one leg while remaining balanced. They are allowed to extend their hands sideways to steady themselves. Alternate legs.
- ❑ **Rubber Leg.** The skiers first stand tall on one leg/ski, and then relax it, letting it slump into a flexed position at the ankle and knee. Alternate legs.
- ❑ **One-Legged Pops.** The skiers pop/spring off one leg, which is bent, and then land on it. Alternate legs.





- ❑ **Jackrabbit.** Each letter represents a stretch or activity. Have the participants guess the next letter and/or activity:
 - ✓ **J** Jump and reach for the sky three times.
 - ✓ **A** Arch your back, in all directions, three times.
 - ✓ **C** Crouch and stand five times.
 - ✓ **K** Kick each leg out slowly to the front and back, three times each side.
 - ✓ **R** Reach to the left and right extending far enough to pull your opposite leg off the ground - five times each side.
 - ✓ **A** Achilles tendon stretch – slide your right ski forward and bend your knee parallel to the ground. Keep your left leg straight with your ankle locked. Repeat with the other leg.
 - ✓ **B** Bounce on your toes fifteen times.
 - ✓ **B** Bend like a tree - left side, front, right side.
 - ✓ **I** Itch – scratch each shoulder.
 - ✓ **T** Tips - touch the tips of your skis with your hands.
- ❑ **Back Leg Lifts.** The skiers extend one leg/ski rearward and off the snow while bending forward at the waist. They then move the same leg/ski forward, without weighting it, and return their upper body to an upright position. Repeat with the opposite leg.
- ❑ **Poison Peanut Butter.** The skiers lift one ski and then the other off the snow so that the “poison peanut butter” (i.e. the snow), doesn’t stick to their skis. The coach encourages the skiers to keep moving by saying “quick, don’t let the peanut butter stick!”
- ❑ **Stepping Movements.** These movements are the basis of the Side Step and Star Turn. They follow on from the “Poison Peanut Butter” exercise above. This exercise should be introduced on packed snow, but it can also be practised in deeper snow when the skiers are ready for the challenge. Another option is to set several ski tracks parallel to each other. To begin with, have the ski poles lying on each side of the skier, parallel to their skis. The skiers step over the poles going first in one direction, and then the other. As the skiers gain competence, several poles can be lined up for them to step over, or they can be placed farther apart to require a longer step. The skiers can also try to jump over the poles with both feet.
- ❑ **Pushaways.** Two skiers (partners) face each other, standing on their skis with their feet wide apart for solid balance. One ski is placed between the partner’s skis, with the tips reaching behind the partners’ heels. The skiers can improve their balance and agility skills by trying to push their partner off balance.
- ❑ **Snakes.** Skiers form a line, one after the other, with about two metres between each. The skier at the end of the line weaves between the other skiers until he/she comes to the front of the line and then becomes the new leader. For advanced skiers, this exercise can be practised with all the skiers moving slowly forward while the skier from the end of the line is trying to weave forward to the front of the group. Variations can be done on the flat, on a slight downhill, or by skiing around other skiers or other objects.





- ❑ **Rubber Knees.** The skiers descend a slight incline using rubber knees and ankles to help absorb bumps.
- ❑ **Tip and Tail Touch.** While skiing down a gentle slope, the skiers alternate between touching the tips and tails of their skis with their hands.
- ❑ **Slide Tall and Slide Small.** The skiers descend a slight slope, exerting pressure on the tongues of their boots by bending their legs slightly. They alternate between putting a lot of pressure on the tongues (slide small) and a little pressure (slide tall). Challenge the skiers to touch the ground and lift their arms in the air while coming down the hill. Ask them to throw their mitts in the air and catch them while coming down the hill. Then ask them to catch a glove and throw it back to you (the coach) when they get to the bottom of the hill.
- ❑ **Hinge Hop.** While skiing down a gentle slope, the skiers hop, lifting their ski tails and leaving their tips on the snow.
- ❑ **Luge.** While skiing down a gentle slope, the skiers first lie back on their skis. Next they practise squatting on their skis until they almost touch the snow with the seat of their pants.
- ❑ **Terrain Leap.** Using their poles, the skiers practise a small upward and forward jump, tucking their knees up towards their chest.





This section is directed primarily at supporting you in your role as a coach working with children in the FUNdamentals stage of development. For a more comprehensive explanation on how to teach classic and downhill techniques to coaches and older athletes, refer to section 8 of the CCI-Learning to Train Reference Material.

4.2 Teaching Classic Technique

The development of excellent ski technique is an ongoing challenge for skiers of all ages. Improvements in waxes, equipment and trail grooming allow for faster speeds. The new, higher speeds have in turn allowed techniques to be done differently. For this and other reasons, improving ski technique is a never-ending process.

Fortunately the tools available to help skiers learn technique are also evolving. Instruction manuals, instruction videos, frame by frame video replay cameras and improved methods of evaluating and correcting technique are increasingly accessible to both coaches and skiers. In addition, an increasing number of clubs are offering skill development programs to a broader age range of skiers than ever before, and the standard of coaching has improved dramatically in recent years. The following is one method to help enthusiasts learn more about technique.

Characteristics of the “Best” Skiers!

- ❑ The “big three” characteristics are the following:
 - ✓ Good balance.
 - ✓ Good weight shift.
 - ✓ Good rhythm (i.e. correct body positioning, body movements and timing).
- ❑ Other important characteristics are as follows:
 - ✓ Good forward movement – “gains lots of ground”.
 - ✓ Generates and maintains momentum – “keeps the wheels turning”.
 - ✓ Good at creating force in the direction of travel – not up, down or sideways.
 - ✓ Good at changing technique to match terrain, snow and track conditions.
 - ✓ Good physical condition.
 - ✓ Good kinaesthetic feel.





4.2.1 Classic Technique Checklists

To simplify the detection and correction of technique errors when you are out on the snow, a series of checklists has been developed.

Common Checkpoints

The following checkpoints are common to all classic techniques (with notable exceptions for Double Pole technique, in which there is no leg push):

❑ Overall

- ✓ All techniques originate with the general athletic stance, modified for the specific technique being learned.
- ✓ Weight shifts fully from ski to ski (not applicable in Double Pole).
- ✓ The skier is balanced on the gliding ski, in Diagonal Stride and One-Step Double Pole.
- ✓ Motion of arms and legs is snappy and forceful.

❑ Lower Body

- ✓ Good angle is maintained at the ankle to permit forward upper body position and correct alignment of hips over the foot at the critical instant of leg and arm push.
- ✓ Leg push is preceded by a pre-load of the gliding leg before it initiates the push.
- ✓ Leg pushes down, into the snow, and slightly back.
- ✓ Leg push is executed quickly and effectively so that power is transferred quickly to the snow and a resulting glide is created.
- ✓ Hip, knee and ankle joints contribute to the leg push in that order, constituting a sequential but very rapid and explosive movement.
- ✓ Hips should rotate slightly to allow body weight to be balanced over the gliding ski.
- ✓ Hips are high and forward over the glide foot (or feet).

❑ Upper Body

- ✓ Poles are planted close to skis.
- ✓ Skier reaches high and forward with bent arms; the amount of elbow bend and the elbow orientation (i.e. tight to the body or pointing slightly outward) vary with the particular classic technique being executed, the phase of the technique and the pitch of the slope being climbed.
- ✓ The shoulders are parallel to the ground.
- ✓ The shoulder, back, core and arm muscles are engaged in poling action.
- ✓ The back is slightly rounded (no hyper-extension).
- ✓ There is a distinct, but not excessive, forward body lean (achieved through flex in ankles).





Diagonal Stride

☐ Most Important

- ✓ The skier commits weight fully to the gliding/supporting ski in the glide phases.
- ✓ The recovery foot is unweighted until placed on the snow ahead of the other foot (with ankle pushed ahead of knee as upward slope increases).
- ✓ The middle of hips is over toes at initiation of leg push, and further ahead as slope of hill increases.
- ✓ Forward body lean comes from a flexed ankle.
- ✓ Hips rotate slightly during leg push, without twisting the upper body.
- ✓ There is a pre-load and explosive leg push (knee and ankle are momentarily straightened and flexed to load the leg, followed by the forceful extension of the leg push).

☐ Very Important

- ✓ There is complete extension of the leg and arm at the end of their respective pushes.
- ✓ There is a straight line through the upper body and leg as the push leg leaves the snow.
- ✓ The gliding/supporting leg straightens (without the knee locking) during the glide phases.
- ✓ The recovery leg is swung forcefully forward in a pendulum motion.
- ✓ The arm action is generally straight forward and back, hinging as a pendulum from the shoulder.
- ✓ Arm push ends shortly after hands pass legs, with natural follow-through continuing.
- ✓ The shoulder reaches forward on pole plant, hands at or below shoulder height.

☐ Important

- ✓ The pole is generally planted opposite the glide foot; as the slope increases, the pole plants a bit farther back.
- ✓ The flex in the elbow joint increases as the poling action commences.
- ✓ At pole release, the skier extends the wrist/hand, with pressure exclusively on the pole strap.

Double Pole

☐ Most Important

- ✓ The hips, upper body and arms are well forward and high to load the poles on pole plant.
- ✓ The forward body position originates in well flexed ankles.
- ✓ The skier “falls forward” and “hangs on poles”.
- ✓ The skier pulls down on the poles, engaging the back, shoulder, core and arm muscles.





❑ Very Important

- ✓ Elbows are moderately flexed on pole plant, with the degree of flex increasing with the amount of force being applied.
- ✓ The elbow flexion increases as the poling action begins.
- ✓ Legs are slightly flexed on pole plant, with flex increasing noticeably – but not excessively – during the poling action.
- ✓ If the skier rises on the balls of feet, motion should be forward, not up.
- ✓ Arm recovery forward (not up) is aggressive, with shoulders leading.

❑ Important

- ✓ Upper body compression ends before the horizontal position.
- ✓ The upper body stays down until the arms are finished.
- ✓ The poles are planted in front of the bindings (or at the binding when glide speeds are lower or body position not as far forward).
- ✓ At pole plant, the shafts are nearly vertical, with grips slightly ahead of pole tips.

One-Step Double Pole

❑ Most Important

- ✓ The leg push, stride and arm reach forward occur simultaneously, and are all snappy/forceful.
- ✓ As the leg push is initiated, the push leg is fully weighted, with weight shifting dynamically to the striding leg as the push ends.
- ✓ The skier is balanced on one fully weighted gliding ski – weight centred over the forefoot – during the free glide phase and as the poling motion is initiated.
- ✓ The poling action is as for Double Pole in several respects:
 - The upper body and arms are well forward and high to load the poles for pole plant.
 - The hips are high and forward, to the extent possible (though they will not be as far forward as in Double Pole).
 - The skier “falls forward” and “hangs on poles”.
 - The skier pulls down on the poles, engaging the back, shoulder, core and arm muscles.

❑ Very Important

- ✓ There is a pre-load of the push leg before the push.
- ✓ Elbows are moderately flexed on pole plant, with the degree of flex increasing with the amount of force being applied.
- ✓ The elbow flexion increases as the poling action begins.





- ✓ Legs are slightly flexed on pole plant, with flex increasing noticeably – but not excessively – during the poling action.
- ✓ Arm recovery forward (not up) is uninterrupted, with shoulders leading.

❑ **Important**

- ✓ Upper body compression ends well before the horizontal position (i.e. there is less compression than in Double Pole).
- ✓ Relative to the Double Pole, the upper body rises more quickly from its compression (to enable the body to be positioned for the pre-load, leg push and stride that occur at the beginning of the next cycle).
- ✓ The poles are planted well in front of the binding of the gliding ski.
- ✓ At pole plant, the shafts are nearly vertical, with grips slightly ahead of pole tips.





4.3 Teaching Cross-Country Ski Skills to Children

The Skill Criteria and Evaluation Benchmarks outlined below go hand in hand with the sample practice plans in section 5 and the Skill Checklists in this section.

4.3.1 Skill Criteria and Evaluation Benchmarks - Level 1

When the skiers you are coaching have completed the recommended program for their age and skill level (for example, the Level 1 practice plans outlined in section 5 of this manual), the next step is to evaluate their skills. Evaluation will determine whether or not they have satisfactorily completed this stage of the program and earned the applicable technique award, or whether they need to do more work on specific skills before they graduate to the next level.

For this task you will require a clipboard, pencil(s) or permanent felt pen(s) and photocopies of the applicable evaluation criteria and checklist. To protect the criteria and checklist from the weather, you will need a paper-size sheet of plastic fastened to the top of your clipboard, or some similar protective measure.

In general, poles should not be used when these skills are introduced. Skiers may rely too much on the poles and not enough on body position for balance.

Ready Position

This technique should be practised and assessed on packed, flat terrain.

- The skier stands with arms and hands slightly forward and to the side for balance
- Skis are kept parallel
- Body is upright, but relaxed
- Knees and ankles are relaxed and slightly bent
- The skier remains in this position for several seconds





Falling and Rising

This technique should be practised and assessed on a gentle slope that is packed but not too hard or icy.

- The skier glides down the hill without poles, and falls to the side and back in a sitting motion
- Skis and legs are kept together
- Skis are brought together, side by side and under the body, on the downhill side of the body and perpendicular to the fall line (the same path a ball would take if it rolled down the hill)
- The skier moves on to his/her hands and knees
- The skier edges skis and stands up with minimal or no assistance
- Once the skier can accomplish the skill effectively without poles, poles should be used. Poles need to be moved parallel to the skis as the skier prepares to rise



Side Stepping

This technique should be practised and assessed on a gentle slope that is packed but not too hard or icy. Poles could be used, but may make this exercise more difficult to accomplish.

- The skier stands on the flat at the start of a gentle slope, with skis perpendicular to the fall line
- Arms and hands forward and to the side for balance
- The skier places his/her weight on the downhill ski and then lifts the uphill ski, placing it 10 to 20 cm uphill from the original position
- The downhill ski is then placed beside the uphill ski
- Skis are kept parallel
- Repeat for five repetitions
- The skier should also practise going down the slope using five side steps





Star Turn

This technique should be practised and assessed on packed, flat terrain.

- The skier stands in the Ready Position, in loose snow, with skis parallel and arms away from the body for balance
- The skier places his/her weight on the left ski
- The skier then lifts up the right knee and places the right ski back down with the tips about 20-30 cm apart, keeping the tails together. The skis form a “pizza slice”
- The left ski is then moved parallel to the right ski
- This is repeated until a full circle is completed
- Repeat in the opposite direction
- On flat terrain and packed snow, the skier can repeat the above points, but keeping the tips together and positioning the tails 20-30 cm apart



Tracking

This technique should be practised and assessed on flat terrain with several metres of clear-cut, set tracks. No poles are used.

- The skier moves forward down the track and steps sideways out of the tracks, without breaking them
- The skier is able to get out of both sides of the track and come back into it easily while moving forward





Diagonal Stride

In the progression of the Diagonal Stride this is the “running step”. This technique is practised and assessed on flat terrain with set tracks.

- The skier slides his/her skis down the track
- The skier “walks” down the track on the balls of the feet with some ankle and knee bend
- There is some glide onto the forward ski as the skier pushes off
- There is a “jogging-like” action on the balls of the feet, with glide onto the forward ski
- After the skier’s weight is shifted to the gliding ski, the pushing ski momentarily comes off the snow at the end of the push
- Arms swing comfortably (somewhat in opposite time to the leg’s stride)



Herringbone

This technique should be practised and assessed on a gentle slope that is packed, but not too hard or icy.

- The skier steps up a gentle slope, alternating arms and legs
- The skier maintains the tips quite wide apart (in a “V” shape)
- Arms swing comfortably
- The skier completes five steps with each leg





Free Glide

This technique should be practised and assessed on a gentle downhill slope that is packed but not too hard or icy. Ideally, the bottom of the hill should be flat (for emergency landings).

- The skier starts at the top of the hill in the Ready Position (the body is generally upright, knees and ankles are relaxed and slightly bent)
- Hands are kept forward
- Skis are kept parallel
- The skier is able to glide three metres down the slope maintaining the Ready Position



Snowplow Braking

If the skier can demonstrate a stable Ready Position moving down a gentle slope, he/she is ready to be introduced to Snowplow Braking on a similar slope.

- The skier makes a wedge, by spreading the tails of the skis apart (the tips come together)
- The skier controls his/her speed by adjusting the size of the wedge and edging their skis
- The pressure (braking) on each ski is fairly equal, with minimal turning to one side
- The skier maintains the upper body in the Ready Position





4.3.2 Skill Checklist - Level 1

	Ready Position																				
	Falling and Rising																				
	Side Stepping																				
	Star Turn																				
	Diagonal Stride																				
	Herringbone																				
	Free Glide																				
	Snowplow Braking																				
	General Comments																				





4.3.3 Skill Criteria and Evaluation Benchmarks - Level 2

In general, poles are used when learning/practising the following skills.

<p>Diagonal Stride</p> <p>In the progression of the Diagonal Stride this is called the “gliding step”. It is practised and assessed on flat terrain with set tracks.</p> <ul style="list-style-type: none"> • Some glide occurs with each stride • The skier lifts skis off the snow when kicking. There is a weight transfer about 50% of the time, and the recovery foot lands beside or in front of the glide foot. • The skier can perform five successful strides in a row, but balance may be insecure and unnecessary movements may occur • Poles are typically not yet used for propulsion, but are used in an alternating arm action • The body is mainly upright in the Ready Position 	
<p>Herringbone</p> <p>This technique should be practised and assessed on a moderate uphill slope that is packed, but not too hard or icy.</p> <ul style="list-style-type: none"> • The skier steps up a moderate slope, alternating arms and legs • Tips are kept quite wide apart (in a “V” shape) • The inside edge of each ski is angled into the snow to eliminate slipping • Arms swing comfortably • The pole tips are planted behind and to the side of the feet, and the hands are just below shoulder height • There is good weight transfer from ski to ski • The skier completes five steps with each leg 	





Double Poling

This technique should be practised and assessed on a slight downhill slope with set tracks.

- The skier pushes down the track for five metres using only the upper body
- The skier reaches their hands forward to plant the poles
- The pole tips do not come ahead of the pole handles when they are being planted
- The upper body flexes at the waist just after the poles are planted to provide additional propulsion
- The upper-body movement is completed by extending the arms to the rear
- The legs remain fairly straight, but not rigid, through all phases of the movement



Free Glide

This technique should be practised and assessed on a moderate downhill slope that is packed but not too hard or icy. Ideally, the bottom of the hill should be flat in case of emergency landings.

- The skier starts at the top of the hill in the Ready Position; the body is generally upright; knees and ankles are relaxed and slightly bent
- Hands are kept forward
- Skis are kept parallel
- Pole handles are down in front of the body and the tips are angled behind, so the pole shaft is generally angled down and backward without dragging on the snow
- The skier is able to glide five metres down the slope maintaining the Ready Position





Kick Turn

This technique should be practised and assessed on flat terrain, in loose snow

- The skier stands in the Ready Position
- The skier then reaches back with the right arm outstretched and plants the right pole on the outside of the left ski, near the tail
- Both poles are now planted on the same side of the left ski
- The skier faces to the right
- The skier now lifts the right ski, bending at the knee and hip so the tail of the ski drags on the snow and the ski is perpendicular to the ground
- The skier now moves the right leg so the skis are parallel but the tip of the one ski is beside the tail of the other
- The left leg and pole are now brought around so the ski tips are together and the skier resumes the Ready Position, having completed a 180 degree turn
- The skier performs the technique in both directions
- At this level the skier may require some assistance.





Snowplow Stop

This technique should be practised and assessed on a moderate downhill slope that is packed, but not too hard or icy.

- The skier begins by demonstrating Snowplow Braking
- The skier returns to the top of the slope
- The skier moves down the hill in the Ready Position showing a good wedge and keeping the ski tips together
- By applying equal pressure on the inside edges of the skis (rolling inward with the ankles) the skier is able to safely reduce speed to a full stop
- Half-Snowplow Braking
- The skier Free Glides down the track on an easy to moderate hill and in softer snow conditions
- Part way down the skier lifts the right ski out of the track and places it in a wedge position with the tip close to the tracks and the tails farther away
- Pressure is applied to the inside edge of the right ski by shifting much of the skier's weight to the ski and rolling inward on the ankle
- The pressure is applied until the skier is able to significantly reduce speed
- Both skis are then placed parallel in the tracks
- Repeat with the left ski



Snowplow Turn

This technique should be practised and assessed on a moderate downhill slope that is packed, but not too hard or icy.

- The skier starts down the hill in a proper Snowplow position
- The skier applies his/her weight unequally to the skis, so most of the body weight is placed on the right ski and the ankle is rolled inwards. This will cause the right ski to start to move perpendicular to the fall-line
- The skier continues to face down the hill
- After the skier's skis turn to the left, he/she unweights the right ski and transfers his/her weight mainly to the left ski while rolling the left ankle inward
- The skier completes two successful turns

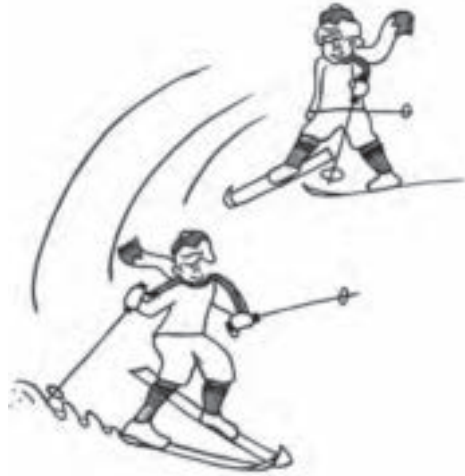



4.3.4 Skill Checklist - Level 2

	Diagonal Stride																			
	Herringbone																			
	Double Poling																			
	Free Glide																			
	Kick Turn																			
	Snowplow Stop																			
	Snowplow Turn																			
	General Comments																			





4.3.5 Skill Criteria and Evaluation Benchmarks - Level 3

In general, poles should be used when learning/practising the following skills.

Diagonal Stride

In the progression of the diagonal stride, this is called the “long step”. This technique should be practised and assessed on flat terrain with set tracks.

- The skier shows a clear weight transfer from ski to ski resulting in a longer gliding action
- The ski lifts off the snow when the skier kicks
- The recovery foot usually lands beside or in front of (not behind) the gliding foot when viewed from the side
- The hands are close to shoulder height and elbows are slightly bent at pole plant
- The skier demonstrates some ankle and knee bend, and maintains a slightly forward body lean
- The poles are angled backwards and help provide propulsion; the skier is clearly pushing off of them
- Each pole is planted beside the opposite side ski boot





Double Poling

This technique should be practised and assessed on flat terrain with set tracks.

- The skier reaches the hands forward to plant the poles
- When the poles are planted, the skier is leaning forward slightly, hands are forward at shoulder level, elbows are slightly bent
- Poles are held at a small angle to the snow, pointing backwards. Pole tips are behind the pole handles when they are planted
- The upper body flexes at the waist just after poles are planted to provide additional propulsion
- As the upper body bends to a horizontal position, the arms start to extend, and follow through with a strong extension to the back
- Immediately following the pole plant, the skier is obviously pushing on the poles with his/her upper body weight
- The upper body movement is completed by extending the arms to the rear. The progression is upper body, then shoulders, then elbows. The elbows should not collapse in the initial phase of the pole motion
- Legs remain relatively straight, but not rigid, through all phases of the movement
- After completing the push, the arms and upper body are recovered forward at the same time to initiate another poling action

The skier is able to execute fairly effective poling action and push down the track using the Double Poling technique.





One-step Double Poling

This technique should be practised and assessed on a slight downhill with set tracks.

- The skier stands in the Ready Position with body weight on the left ski
- The skier pushes off the left ski, and transfers all of the weight to the right ski, while reaching forward with the arms to Double Pole
- The skier then initiates Double Poling action while recovering the push foot forward
- The skier glides on both skis, and then begins the cycle again, alternating the pushing leg (this time using the right ski)
- The skier is able to ski 50 metres using this technique

For evaluation purposes the skier needs to demonstrate some weight transfer between the pushing and gliding skis.



Free Skate

This technique should be practised and assessed on a packed, gentle downhill slope.

- The skier is in the Ready Position demonstrating an obvious “V” shape with the skis
- The skier bends the left knee and ankle, pushing off with the left leg and transferring his/her weight onto the right ski
- The right hip and shoulder are aligned over the right ski. As the glide ski slows, the skier flexes the right knee and ankle and pushes off the right ski so his/her weight is transferred to the left ski
- The skier’s left shoulder and hip then align over the left ski. The glide on the left and right skis is consistent
- During each glide, the feet come close to each other
- The skier swings the arms in front of the body (rotation movement)
- Poles are held with the tips pointing backwards, not touching the snow





Downhill Tuck

This technique should be first practised on flat terrain and then evaluated on a medium slope where the skier has a 10 metre run to demonstrate the technique.

- In a “low tuck” the upper body is bent to a horizontal position, and knees and ankles are bent so the thighs are parallel to the snow
- In a “high tuck” the knees and ankles are bent so the thighs are only slightly bent
- Poles are held under the arms and tightly against the body
- The skier can safely descend a medium hill in a low or high tuck



Diagonal Skate

This technique should be practised on a moderate uphill slope.

- The action is similar to that used in Herringbone, but in this case the skier glides on each ski
- Alternating pushes with the arms and legs, the skier glides up the hill shifting the weight from ski to ski
- A pole and the opposite ski touch the snow at the same time.
- The gliding skis should be kept fairly flat on the snow, and not edged until the actual push off
- The arm action is similar to that used in the Diagonal Stride
- Arms are kept close to the body during the initial phase of the arm push





Kick Turn

This technique should be practised and assessed on flat terrain, in loose snow.

- The skier stands in the Ready Position
- The skier then reaches back with the right arm outstretched and plants the right pole on the outside of the left ski near the tail
- Both poles are now planted on the same side of the left ski
- The skier faces to the right
- The skier now lifts the right ski, bending at the knee and hip so the tail of the ski drags on the snow and the ski is perpendicular to the ground
- The skier now moves the right leg so the skis are parallel, but the tip of the one ski is beside the tail of the other
- The left leg and pole are now brought around so the ski tips are together and the skier resumes the Ready Position, having completed a 180 degree turn
- The skier performs this technique in both directions
- At this level the skier should be able to do the exercise without assistance



Skate Turn

This technique should be practised and assessed on a packed, gentle downhill slope.

- The skier performs Double Poling just in front of the place he/she wishes to turn
- As the skier recovers the arms and upper body forward, the inside ski (the ski that is on the side to which the skier is turning) is unweighted and pointed in the new direction
- The skier edges and pushes off the outside ski transferring the body weight to the inside ski
- The skier then glides with the skis parallel and equally weighted in the new direction

Another Double Poling action completes the turn.





4.3.6 Skill Checklist - Level 3

<p style="text-align: center;">General Comments</p>																					
Skate Turn																					
Kick Turn																					
Diagonal Skate																					
Downhill Tuck																					
Free Skate																					
One-step Double Poling																					
Double Poling																					
Diagonal Stride																					
																					





4.3.7 Skill Criteria and Evaluation Benchmarks - Level 4

One-step Double Poling

This technique should be practised and assessed on a slight downhill with set tracks.

- The skier stands in the Ready Position with body weight on the left ski
- The skier pushes off the left ski, and transfers all of the weight to the right ski, while reaching forward with the arms to Double Pole
- The skier then initiates a Double Poling action while recovering the push foot forward
- The skier glides on both skis, and then begins the cycle again, alternating the pushing leg (this time using the right ski)

For evaluation purposes the skier should be able to show a consistent fluid action with good balance at both the pole plant and the end of the pole push phase, and to continue with this technique for 50 metres.



Free Skate

This technique should be practised and assessed on flat terrain or a packed, gentle downhill slope.

- The skier is in the Ready Position demonstrating an obvious “V” shape with the skis
- The skier bends the left knee and ankle, pushing off with the left leg and transferring the weight onto the right ski
- The right hip and shoulder are aligned over the right ski. As the glide ski slows, the skier flexes the right knee and ankle and pushes off the right ski so the weight is transferred to the left ski
- The skier’s left shoulder and hip then align over the left ski. The glide on the left and right skis is consistent
- During each glide, the feet come close to each other
- The skier swings the arms in front of the body (rotation movement)
- Poles are held with the tips pointing backwards, not touching the snow

For evaluation purposes, there should be an obvious and complete weight transfer from ski to ski (the skier glides on one ski and then the other).





One Skate

The One Skate technique requires a poling action (arm push) with each leg push. This technique should be practised and assessed on a packed, gentle downhill slope.

- The skier begins as if Double Poling
- The skier's weight is placed on the right ski, while the left ski is lifted and angled a bit to the side
- Ski tips should be kept 50 cm apart
- The right hip and shoulder are over the gliding ski until the leg push is initiated
- The skier plants the poles with the tips slightly ahead of the binding and initiates a complete Double Poling action
- As the skier pushes down with the upper body and arms, the skier begins to transfer the weight onto the left ski
- Knees and ankles bend before pushing off
- The leg pushes to the side, not back, and as the ski is pushed off it remains parallel to the snow
- The weight transfer is accomplished by edging and pushing off the right ski, and pushing with the arms
- The completion of the poling extension is synchronized with completing the weight transfer to the left ski
- As the skier shifts onto the new ski, the arms are recovered along with the right ski and the sequence is repeated using the opposite arms and legs
- The glide on the left and right skis is consistent
- During each glide, the feet come close to each other





Two Skate

The Two Skate technique is similar to the One Skate except the poling action only occurs with every second leg push. This technique should be practised and assessed on a moderate downhill slope.

- The skier begins as if Double Poling, gliding with the weight on the right ski and the right shoulder and hip aligned over it
- The left ski is lifted and angled a bit to the side.
- Ski tips should be approximately 50 cm apart
- The skier plants the poles with the tips slightly ahead of the binding, and completes a Double Poling push action
- As the skier pushes down with the upper body and arms, he/she begins to transfer weight onto the left ski by pushing off with the right leg
- The skier glides on the left ski, with left hip and shoulder aligned on the glide (left) ski as he/she starts to recover the arms forward
- The skier then skates off the new glide ski (left) using only a leg push
- The arms are recovered forward over the right ski in preparation for another double poling action after the skier has transferred the weight back to the right ski



Step Turn

This technique should be practised and assessed on a packed, moderate, untracked slope.

- The skier starts in a “high” tuck position and glides down the hill
- The skier completes several Step Turns in one direction, using small, quick steps, and consistently maintaining the tuck position
- The skier keeps the weight on the heels
- During this exercise there is a complete weight transfer from one ski to the other
- Skis are edged when weight shifting

The skier can Step Turn both to the left and right.





Parallel Side Slipping

This technique should be practised and assessed on a steep well-packed downhill slope.

- The skier maintains the Ready Position throughout
- By moving the knees and rolling the ankles in and out, the skier shifts the weight alternately on the uphill and downhill edges
- Skis remain parallel while slipping down the hill sideways
- The skier demonstrates control by stopping mid-slope
- The skier should be able to sideslip at least one metre down the hill

The skier is able to demonstrate this skill facing both directions.





Offset

This technique requires a poling action after every second leg push, and should be practised and assessed on a gentle uphill slope.

- The skier begins as if initiating the Two Skate technique, but the ski tips are generally a bit wider apart
- The skier balances on the left ski and pushes with the left leg in order to step up the hill onto the right ski, planting both poles and the right ski at the same time (three point landing)
- The right shoulder and hip should be aligned over the right ski
- The poles are planted in an “offset” position. The right pole is planted with a slight slant to the rear, with the tip beside the right binding. The left pole is angled more sharply back and to the side, with the tip at the left binding
- The skier continues with an action similar to the Double Poling motion but with less bend at the waist
- During the Double Poling action, the skier steps up the hill with the left ski
- The skating (pushing and weighted) right ski is then edged and the skier pushes off with the right leg and arms to begin the weight transfer to the left ski.
- The skier balances briefly with the left hip and shoulder aligned over the left ski. The ski is then edged and the skier pushes off the left leg and steps and shifts the weight onto the right ski, to start the cycle again
- The skier’s weight shifts quickly and does not linger over the ski as it does with One Skate and Two Skate techniques

The skier must be able to offset on both sides – i.e. with right hand leading and with left hand leading.





4.3.8 Skill Checklist - Level 4

	One-step Double Poling																			
	Free Skate																			
	One Skate																			
	Two Skate																			
	Step Turn																			
	Parallel Side Slipping																			
	Offset																			
	General Comments																			





4.3.9 Games for Teaching Technique

Acquiring balance on skis takes time. Children pick it up more quickly than adults do, but they are usually less motivated for skiing itself and may lose interest quickly. Children simply are not small-scale adults.

Adult recreations, such as tours, are often tiring for children, whether or not they are on skis. Their attention spans are simply too short for them to enjoy doing the same thing for any length of time. So introducing children to skiing skills often requires a special approach keyed to their needs and capabilities through suitably arranged learning situations. One of the best ways to introduce children to skiing skills is through games. Almost any game that can be played on foot can be played on skis.

Teaching Children to Ski

- ❑ **Jaws.** Everyone lines up on one side of the field. Have one person stand in the middle of the field and yell “jaws”. When “jaws” is called, all the skiers attempt to reach the other side of the field without getting caught by Jaws. Skiers who are caught then help Jaws to catch other skiers.
- ❑ **Simon Says.** This is the old game where the one who gets caught becomes Simon and that individual continues by trying to trick someone else. If Simon says “Simon says” first, - e.g., “Simon says: touch your toes” or “Simon says: twist at the waist” - the group should follow the instructions. However, if Simon says simply “clap your hands” without saying “Simon says: clap your hands”, no one should clap their hands. Coaches may or may not allow the use of poles depending on the space available to play the game.
- ❑ **Orienteering For Treasure.** First select a suitable location, such as a city park or ski trails. Divide the children into teams of three or four, with one adult per team. Every team is provided with one map. On the map is a picture of where the next map is hidden (for example, a lamp post, if there are numerous lamp posts in the area). There can also be a drawing of a nearby pond, picnic table or similar landmark. The teams then search until they find the next map, which in turn indicates where another map is hidden. There should be one map per team at each checkpoint – ideally, numbered for each team. All teams have to find the same locations, but each trail is laid out in a different order so the teams are not following each other. Another alternative is to follow the same order but have a staggered start. If this is done at a ski area, the maps must include features that the children are familiar with and recognize. A beautiful viewpoint on the 15 km trail may be recognized by adults but not by the children if they haven’t been there before. Keep words and directions to a minimum. If a large school yard or city park is used, set up 15-20 checkpoints with approximately 150-250 metres between each one. In a ski area with hilly terrain, keep the check points closer together. Have the ‘treasure’ ready for each team when it arrives at the last checkpoint.
- ❑ **Ski Orienteering.** This game should be simplified for beginners. The level of difficulty can be increased as the participants gain more experience. Obtain maps of the ski area. These maps can be laminated at most schools or libraries. Use an erasable marker (grease pencil)





to mark the location of the control points for each team. At each control point, put a letter. The skiers, in pairs, then ski to as many control points as they can and record or remember the letter at each station. The pairs return when they have been to all of their control points and can make a word from their letters. Stations are chosen so that each group can spell a word. You could also put numbers at each station and each group gives you the total of their numbers. The team completing the course in the shortest amount of time wins. The level of difficulty can be increased by putting the letters near but not exactly at the control point. It can also be increased by using compass directions to lead the groups from control point to control point.

- ❑ **Wolf Ring:** A defined area with both perimeter and diameter lines is established for the game. Skiing is permitted around the perimeter and across each of the diameters, but in one direction only. A hunter, “the wolf”, chases the rabbits within the defined area. When the wolf tags a rabbit, that person becomes a wolf as well. The game continues until the last rabbit is tagged. The size of the area can vary according to the age of the participants. The coach may or may not choose to have skiers use poles depending on space available to play the game. See Figure 4.1.

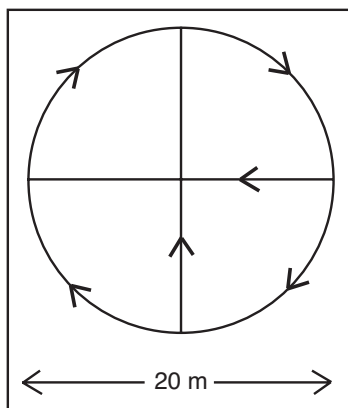

Figure 4.1

- ❑ **Follow the Leader.** This game should be adapted to the age of the group in order to provide a challenge that is suitable. Incorporate the movements that correspond with the skills being taught during that activity/practice session. Keep the group small so that even the last skier in line is doing the activity. A variation is to lead the group out, do an exercise, then have the first skier lead that movement while you go back down the line and encourage others to copy them. When the last skier has finished, reverse the line and lead on to begin the next exercise. For older groups, the exercises need to be progressively more difficult.
- ❑ **Jump the Clock.** The group spreads out (lots of space is required between each skier). All face a point designated as twelve o'clock. When the leader shouts “three”, everyone tries to jump and turn 90 degrees so that their skis face three o'clock. They jump back to twelve o'clock again and this continues. With some practice, some participants may make a jump turn as far as six o'clock. The coach may or may not choose to have skiers use poles depending on space available to play the game.





- ❑ **Schmerltz Rugger.** A Schmerltz is a tube sock with a tennis ball dropped in the toe and a knot tied in the sock. Two goal lines and a field goal ring (about two meters in diameter) are created. A touchdown (six points) is scored by carrying the ball across the opposition's goal line; a field goal (three points) is scored by throwing the Schmerltz into the circle. The idea is to pass the Schmerltz. If a skier is tagged while holding it, the tagging team gets a free throw. Each team should have a goalie to protect the circle. If the Schmerltz is being carried for too long by the skiers, use the three stride rule (three strides and pass). No poles. See Figure 4.2.

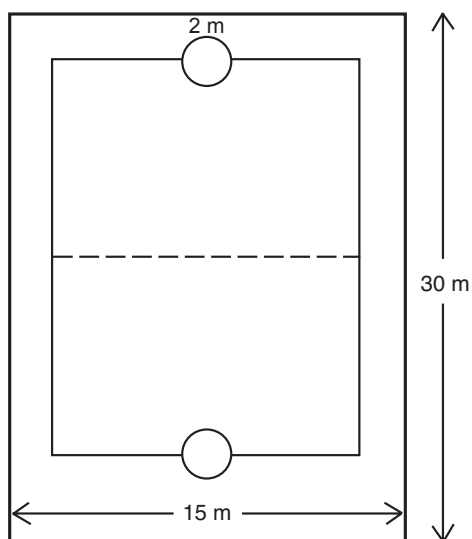

Figure 4.2

- ❑ **Human Slalom.** A long hill is required for this exercise. The first skier goes about ten metres down the hill and stops. The second skier then skis around the first and stops ten metres further down the hill and so on until the whole group reaches the bottom.
- ❑ **Get the Leaders.** Children ski down a gentle slope doing a slalom course. The coaches are watching along the side and each child attempts to grab a handful of snow to throw at each coach they pass, while retaining their balance. The coach may or may not choose to have the skiers use poles depending on space available to play the game.
- ❑ **Colours.** The skiers ski around within a circle six metres in diameter until the coach calls out a colour. They then stop and touch that colour on another skier's clothing. More than one skier can touch the same person. The most fun is selecting a colour that is found only on the socks or gloves of one or two skiers.
- ❑ **Name Tag.** This is a good game for the first session of the year, used by the groups once they have divided up. Start a game of Frozen Tag, but adapt it so the "tagger" has to say a skier's name when he/she tags or frees them. This works well with all age groups. No poles.
- ❑ **Frostbite Tag.** This game is played within a six metre ski pole circle. One person is "It" and another is "Hot Spot". When "It" tags skiers, they must remain frozen with their hand touching the tagged part of their body. They remain frozen until "Hot Spot" touches them on





the frozen spot. Change “It” and “Hot Spot” frequently. Also, you can have more than one “It”. This works well when the “girls” are on one side and the “boys” are on the other side. No poles.

- ❑ **Hounds and Hares.** Hares have a small flag (flagging tape) tied on their arms and are given two minutes to ski off anywhere within the game area. Vary the range according to the age level of the group. Hounds are then sent out to catch the hares’ flags. Hares that lose their flag become hounds. After ten minutes, a whistle is blown and everyone returns. Flags cannot be captured after the whistle. Count the number of flags that the hounds captured and switch roles to see which team does better. Those who lose their flag continue to play by acting as decoys.
- ❑ **Dodge Ball.** For this game you require a soft, air-filled ball (i.e. volleyball). Divide the group into two teams, the “Ins” and the “Outs”. The “Outs” form a large circle within which the “Ins” can move freely. The size of the perimeter of the circle is determined by the throwing ability of the participants. The ball is handed to one of the “Outs” to begin the game. The object is for the “Outs” to knock the “Ins” out of the circle. No hits are allowed above the shoulder. If the ball does not make it back to the outside edge of the circle, an “Out” may enter the circle to retrieve it, but cannot throw until back in position. Each “In” that is hit by the ball has to leave the circle. Once the “Ins” have been removed from the circle, the “Ins” and “Outs” exchange roles. The coach may choose to time each group to see which one can eliminate the other the fastest. No poles.
- ❑ **Streets and Alleys.** This is a fun way to form a teaching grid. The skiers line up in pairs facing the same direction. The second skier in a pair stands about five meters behind the first skier. When the coach shouts “Streets”, the back skier has to try and catch the front skier. When the coach shouts “Alleys”, the skiers turn around. The chaser (the skier behind) becomes the pursued. Use poles if classic skiing.
- ❑ **Swedish Bulldog.** Skiers line up on one side of the field. At a signal from the coach they attempt to cross to the other side of the field without getting tagged by “It”. Anyone tagged also becomes “It”. The game continues until everyone is caught. No poles.
- ❑ **Tattle-Tale Pursuit.** For this game use a loop of the trail which will require 10-15 minutes for the group to ski around (increase the distance as appropriate for the age of the skiers). All skiers except one (the coach or the fastest skier in the group) ski around the loop as quickly as then can. The pursuer waits three or four minutes and then chases the others, tagging each skier they catch. If tagged a skier must turn around and return to the start line. The first skier to escape the pursuer, complete the course and make it back to the start line by skiing the full loop wins the game.
- ❑ **Fish Gobbler.** A square area is marked out as shown with one side designated as “ship” and the other as “shore”. All the fish swim around in the ocean and when “ship” is called, they have to get to the ship, and when “shore” is called they have to get to shore. When “Fish Gobbler” is called, they all link arms within a count of twenty or the “Fish Gobbler” (the coach) will nab them. When “sardines” is called, they all have to cram into a small square in one corner before the count of twenty. This is a good game for young skiers as there is no penalty for being gobbled other than you get caught. No poles. See Figure 4.3.



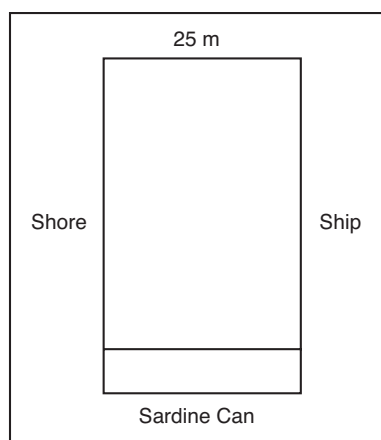

Figure 4.3

- ❑ **Mile Game.** For this game you require three or four bicycle tubes (14" to 16" across). Most bike shops will give these away. Tape back the stems on the tubes so they do not protrude outward and cause an injury. Tubes may be painted various colours. Three to four pylons are also required. Space the pylons and tubes on the hill as shown. Skiers Snowplow or Step Turn (depending on the technique the coach has selected) their way around the first pylon and then Snowplow around a turn to pick up a tube, and so on down the hill. This game can be adapted by having only the pylons, changing the grade of the hill, increasing or decreasing the number of pylons and tubes, increasing or decreasing the distance between the pylons/tubes. No poles. See Figure 4.4.

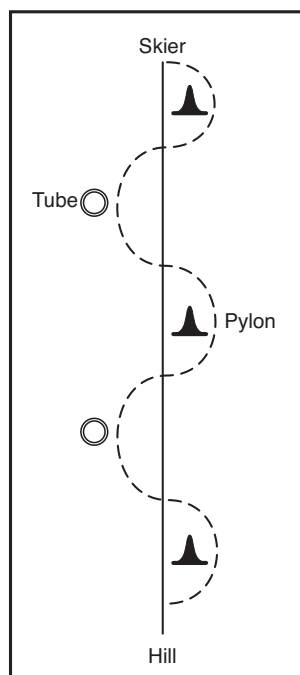

Figure 4.4

- ❑ **Team Station Game.** Teams are formed (size is not important). On a two km trail, set up four or five stations (a bean bag toss, a wheelbarrow run, a three legged run, a slalom course, a hat and glove exchange, etc.). Teams can be sent both ways along the trail as long as it is





reasonably flat. The rules are: (1) no team can start an activity until all of the team has arrived at the station; (2) teams cannot start for the next station until all of the team has finished the activity. The winning team is the first team back to the start with all of its members.

- ❑ **Fox and Rabbit Chase.** This game is played within a square. The square should be as big as the skills of the skiers allow. Markers are required to establish the boundaries. One skier is a fox, and one is the “chase” rabbit. The other skiers are also rabbits, but they are hidden in the forest (the forest is made of ski poles set up in an area within the square). If the chase rabbit becomes tired, he/she may at any time tag one of the other rabbits hiding in the trees, and that rabbit will become the chase rabbit. If the fox catches the chase rabbit, the two exchange roles so that the rabbit becomes the fox. If you have enough skiers, you can have two foxes and two chase rabbits. The coach may or may not choose to have the skiers use poles depending on space available to play the game.
- ❑ **Pablo Rabbit.** Working in pairs, the skiers each draw a giant rabbit in the snow using their skis. Then the entire group skis from rabbit to rabbit to decide which pair of skiers will be the Picasso of the future.
- ❑ **Dwarf-Giant Game.** In this game, the skiers switch back and forth between strides, changing from a “dwarf” to a “dragon” by going from a deep crouch to where their body and arms are stretched upward. Once skiers have mastered this imitation, this game can be adapted to a relay.
- ❑ **Double Pole Race.** The group is divided up into two or more teams. The front skier for each team stands behind the “start line”. The skiers on a team stand one behind the other holding the waist of the skier in front. The lead skier double poles, pulling the other skier/skiers to a line that has been determined as the finish line. Variations are: the lead skier pulls one or more depending on terrain; this game is adapted to a relay format, with other skiers waiting at the finish line to do the next leg of the race; or the skiers behind the lead skier snowplow when they are being pulled forward.
- ❑ **Laugh Line.** The skiers form two lines approximately 1.5 metres apart, and turn to face each other. One skier skis between the two lines, from one end to the other. The others try to make the skier laugh as he/she skis down the line. The group can do whatever it wants to make the skier laugh, except touch him/her. If the skier laughs, he/she is out of the game. If the skier manages to complete the trip without laughing, he/she returns to his/her original position. This game can be adapted according to the number of skiers in the group.
- ❑ **Three-Legged Race.** This can be a single start race with all skiers paired, or the pairs can form teams and it can be done as a relay. Each pair of skiers has adjacent legs tied together with a strip of cloth. No poles are used. The skiers ski out to a pylon and back. If it is a relay, they help the next pair get their legs tied. Coordination of strides is the skiers’ goal. The better skier of the pair will often encourage the other to take bigger strides, glide or even use a marathon skate.
- ❑ **Monster Skis Relay.** For this game you need several pairs of monster skis. These consist of six foot long pieces of 1” x 6” board. Pairs of holes are drilled every 16” (four pairs), through which loops of rope are tied for bindings. With four people on each pair, it is a race to the end! This is a very popular game.





- ❑ **Beat the Field.** Two teams are formed, “hitters” and “fielders”. The hitting team lines up in a row facing the fielders. The fielder’s team is scattered. The first skier on the hitting team hits the tennis ball, volleyball, etc., with his/her hand and then proceeds to ski around his/her team. As soon as one person on the fielder’s team has fielded the ball, the rest of the team lines up behind him/her and the ball is passed, from hand to hand, between the legs until it gets to the last person who yells “Stop!” One point is scored for each complete circuit. The hitter goes to the end of the line and the second person hits. When one side is done, “hitters” and “fielders” switch sides. Keep the teams fairly small (six or less). The coach may or may not choose to use poles. See Figure 4.5

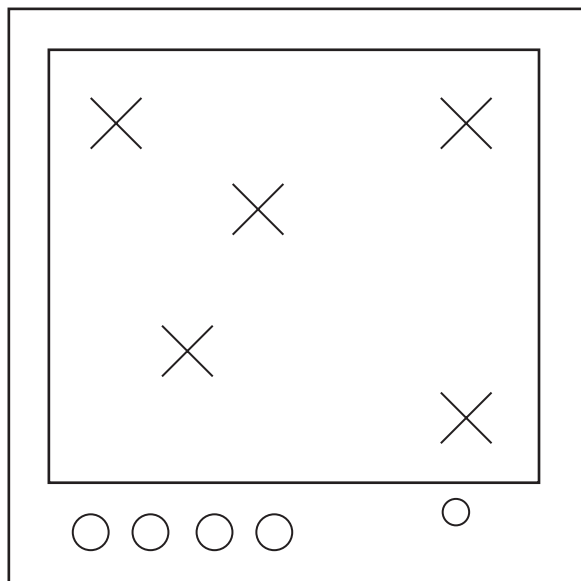

Figure 4.5

- ❑ **Hokey Pokey.** The group stands in a circle and sings “You put your right ski in, you take your right ski out, and shake it all about, you do the Hokey Pokey and you turn yourself around...” to the tune of the Hokey Pokey. Repeat using different parts of the body. Finish the game with all the skiers sliding towards the centre of the circle for one last, rousing round.
- ❑ **Superheroes.** Have the skiers lean forward as if they are going to fly, like Superman or Superwoman. Test how far they are willing to lean from the ankles before they move their feet.
- ❑ **Moving Bridges.** The group is divided up into pairs. One pair of skiers creates a bridge with their arms, which all the other pairs have to duck under. When the second pair of skiers ducks under the bridge, they turn to face each other and create a second bridge. Each pair of skiers builds a bridge at the end of the tunnel when they finish going through it. The group can travel around trees or other areas with their moving bridges. If the skiers are advanced enough to manage it, progress to a gentle slope. No poles.
- ❑ **Musical Poles.** This game is a version of Musical Chairs. The skiers stand about two metres apart in a single line. Some poles are stuck in the snow in a row opposite, about 20-30 metres away. The number of poles should be one less than the number of skiers. At a signal from the coach (the music stops!), all the skiers race to get a pole. The skier who ends up





empty handed has the task of setting up the poles for the next round. Remove one additional pole each time.

There are many games that can be used to develop balance, coordination and ski technique skills. Often these games allow the skiers to learn a skill naturally by diverting their attention away from the mechanics of completing the action.

- ❑ **Chain Tag.** The skiers play this game within a marked circle. One skier is “It”. When “It” tags another skier they hold hands, and try to tag other skiers. Each skier that is tagged joins the chain by holding hands with the skier at the end of the chain. The game continues until every skier is part of the chain. A variation is to have two “Its” forming chains, and the chain with the most skiers at the end is the winner. No poles.
- ❑ **Relays.** A relay can be as simple as lining up in teams and using the technique of the day to ski around a pole and back. The following are examples of more complex relays. These relays can be run with one group just for fun, or with several groups in competition. Unless otherwise indicated, you can use them to practice any ski technique that you wish, although with the “rougher” relays, it is strongly suggested that poles should not be used. The distance that skiers ski for their leg of the relay should be kept relatively short. It is better to do several short relays than one long one.
 - ✓ **Long Eared Memory Relay.** The teams line up one behind the other. The first person skis ahead about ten metres. He/she is given a card with a saying on it to memorize (this can vary in difficulty according to the age group), e.g. “The rain in Spain falls mostly on the plain”. At the signal, the skier skis his/her leg of the relay then returns to the transfer point to which the second skier has moved up and passes the saying on verbally. This continues through the line to the final skier. The winning team is the one which comes closest to repeating the original saying to the coach.
 - ✓ **Snowball Relay.** Skiers ski to the end point, as shown, where they make a snowball and throw it at a target, trying to score as many points as possible. The team with the most points wins.
 - ✓ **Scooter Relay.** This is a good game for emphasizing glide. Skiers simply remove one ski and scoot their lap of the relay. Have the skiers do this with both legs, as balance is often much worse on one leg than the other.
 - ✓ **Number Relay.** Teams of four are formed and each team member is numbered from one to four. For this relay you can have a turn-around pole for each team (or have only one turn around pole for all the teams to use). The coach then calls out a number (or numbers) and the skiers with that number race around their pole and return to their team. The first skiers back earn a point for their team. Keep the distance to the pole short so that the skiers stay active.
 - ✓ **Bell Relay.** Form two teams. Blindfold the first person in each line. The coach stands some distance away and rings a bell. The skiers try to ski around the bell and back to their line blindfolded. A paper bag makes a very effective blindfold for older skiers;





younger ones can use a scarf which allows them to “cheat” a little. The rest of the team should shout directions and encouragement to the blind skier on their team.

- ✓ **Soccer Relay.** Each team has a balloon and a turn-around pole. The skier must kick his/her balloon to the pole, around it and back. The first team finished is the winner. Keep the distance short. Make sure you have many extra balloons.
- ✓ **Newspaper Relay.** Pile an equal number of sheets of newspaper (for each team) at the turn-around point. Skiers in turn ski to their pile, take one sheet of paper and return to the start of the line where they crumple it up and put it in their garbage bag. First team to fill their bag wins.
- ✓ **Hula Hoop Relay.** In turn, skiers ski to a turn-around point where their team has a hula hoop. They must drop it over their heads so it sits on their skis, remove it, and return to their team.
- ✓ **Ball Relay.** Skiers hold a ball in front of them and ski to a turn-around point. They return holding the ball behind their backs and tag the next team member. Keep the distances short and the teams small so that skiers are not inactive for very long periods of time.
- ✓ **Obstacle Course Relay.** For each team, create an identical course. Slalom around poles, ski under a rope, over a rope, and whatever your imagination and the terrain allow.
- ✓ **Who Can?** Each of the following questions can be used for a relay theme:
 - ✓ _____ Who can glide the farthest on their skis?
 - ✓ _____ Who can take the fewest strides between two points?





PROGRESS REPORT FORM

Podunk Jackrabbits - Progress Report

Name: I.M. Realfast

Date: March 10th, 20xx

Skill Level Completed: Level 3

Skill Level Working On: Level 4

Coach: Tom Green

<i>Skill</i>	<i>Comments</i>
Diagonal Stride	Good. Good glide, weight shift and forward upper body lean. Needs more work on landing recovery foot beside or ahead of glide foot.
Double Poling	Good. Good upper body flex, arm follow through and straight legs. Work on the pole plant to make sure tips are not too far ahead (not ahead of the handles)
Free Skate	Good. Good glide on each foot. You need to work on "lining up" your toes, knees, hips, body and same side shoulder in the direction of your glide ski.
One-step Double Poling	Good. Passed this skill previous season.
One Skate	Needs more work. You need to work on "lining up" (see Free Skate) and on using a "Double Pole" to start both left and right glides.
Step Turn	Needs more work. You are good on the Ready Position, but you need to work on small, quick steps and shifting your weight from ski to ski.
Diagonal Skate	Good. Remember to keep your gliding skis flat on the snow.
Kick Turn	Excellent. Good Kick Turns, even on steeper slopes and in deep snow. Don't forget to work on this important skill for back country skiing!
Downhill Tuck	Good. Good bending of upper body to horizontal. Good arms and hands position (well forward of body). You need to work on a deep bend for the low tuck, so your thighs are parallel to the snow.
Classic Skiing	Excellent. Good Diagonal Stride for 10 minutes.
Skating	Needs more work. More practice needed for One Skate technique.

Summary: I.M. has been a very enthusiastic skier in all of our classes. His skills and interest in skiing have developed a lot this year. He should have no problem getting his Level 4 Award next year, if he keeps up the good work! I have really enjoyed having him in my group.





REFERENCES

Games. Nakkertok Ski Club.

Games and Activities. *CCBC Ski League Leader Manual*, 2000, pp 241.

Skill Criteria. *CCBC Ski League Leader Manual*, 2000, pp. 294.

Progress Report. Kimberly Nordic Ski Club.

Games. *CCC Jackrabbit Ski League Manual*, 1996.

Skill Criteria. *CCC Jackrabbit Ski League Manual*, 1996.

Nadeau, G. *Technique Illustrations*, 2001.

Nemi, A. *Technique Illustrations*, 2005.

Gullions L., *Ski Games*. Champagne, Illinois. Leisure Press, 1990.





SECTION 5 - DESIGNING AN OVERALL PLAN FOR THE SEASON



Coaching Tip: Adult activities such as tours are often tiring for children, whether or not they are on skis. Their attention spans are simply too short for them to enjoy doing the same thing for any length of time. So introducing children to skiing skills often requires a special approach, keyed to their needs and capabilities through suitably arranged learning situations. One of the best ways to introduce children to skiing skills is through games. Almost any game that can be played on foot can be played on skis.

Source: Teaching Children To Ski



This section on Designing an Overall Plan for the Season Plan complements the information provided in section 5 of your Introduction to Community Coaching materials, and is directed primarily at supporting you in your role as a coach working with children in the FUNDamental stage of development.

5.1 Designing a Seasonal Plan

5.1.1 Seasonal Plan Checklist

Your club's overall Skill Development Program (SDP) plan for the season should include the following:

- Plan a meeting with the parents prior to the first practice to ensure they have a good understanding of the overall program, the schedule for the season, what is expected of them, what equipment their children require, etc.
- Enlist parental support to organize the special activities and indoor sessions that you are responsible for.
- Plan to make maximum use of the snow season. The annual window of opportunity to learn sport-specific technique is short compared to that of most other sports.
- Plan for the change in seasons. The best time to hold the indoor sessions such as a ski preparation workshop or a winter safety sessions is when winter is approaching and the weather is not suitable for any outdoor activities - dryland or on-snow.
- Avoid conflicts with school schedules when planning multi-day activities such as ski camps or overnight hiking trips. Make good use of school holidays, especially the Christmas holidays.
- Include approximately one hour of "game time" for every three hours of skill instruction to ensure a well-balanced skill development program. In this context, game time means special activities that test a skier's skills against those of his/her peers in relays, races, sprints, etc. with an emphasis on team effort.
- Be prepared to adapt your practice plans based on the abilities of the skiers and the particular characteristics of the ski area.
- Refer to section 5.1.1 of your Introduction to Community Coaching Reference Material for additional information.

5.1.2 Incorporating Special Activities

- Intersperse indoor educational sessions and special activities throughout your plan to ensure a well-rounded, interesting program.
 - ✓ Some special activities will be organized by your club, such as Ski Tournament, race, New Year's Moonlight Ski, etc.





- ✓ Others will be organized by your SDP Programmer - Year-End Activities, Sprint Games, Mini-Olympics, Ski Orienteering, Winter Safety Session, etc.
- ✓ Still others will be organized by your own group, such as a Ski Preparation Workshop, a Treasure Hunt, or day trip to a lake or backwoods cabin.

Figure 5.1: Special Activities Grid

Level	Pre-Ski Season Sessions	Indoor Sessions	Special Activities	Total # of Practice Sessions	Minimum # of Snow Goals
1	0	1) Ski Preparation (Plan 3) 2) Dressing for Winter (Plan 8)	1) Special Activity (Plan 6) 2) Treasure Hunt (Plan 12) 3) Year-End Activity (Plan 16)	16	5
2	0	1) Ski Preparation (Plan 3)	1) A Club Activity (Plan 7) 2) Sprint Games (Plan 11) 3) Year-End Activity (Plan 16)	16	10
3	11	1) Ski Preparation (Plan 12) 2) Winter Safety (Plan 13)	1) Christmas Activity (Plan 16) 2) Holiday Ski Camp (Plan 20-21) 3) New Year's Activity (Plan 22) 4) Classic Relay (Plan 27) 5) Backwoods Adventure (Plan 30) 6) Modified Ski Tournament (Plan 32) 7) Orienteering Poker Ski (Plan 35) 8) Downhill Games (Plan 36) 9) Sprint Games (Plan 37) 10) Year-End Activity (Plan 40)	40	15
4	11	1) Ski Preparation (Plan 13)	1) Christmas Activity (Plan 16) 2) Holiday Ski Camp (Plan 20-21) 3) New Year's Activity (Plan 22) 4) Ski Tournament (Plan 27) 5) Downhill Games (Plan 29) 6) Backwoods Adventure (Plan 30) 7) Mini-Olympics (Plan 32) 8) Ski Race (Plan 35) 9) Sprint Games (Plan 37) 10) Year-End Activity (Plan 40)	40	20





5.1.3 Seasonal Plan Chart

SEASONAL PLAN									
	SEPTEMBER	OCTOBER	NOVEMBER	DECEMBER	JANUARY	FEBRUARY	MARCH		
Active Start (5 years & younger)	REGISTRATION – ALL AGES								
FUNDAMENTALS (6 -7 years)					4	8	4	YEAR END ACTIVITIES	
FUNDAMENTALS (8-9 years)		4			8	10			
Learning to Train (9-11 years)	3	8	8	8	10	10	3		
Learning to Train (11-12 years)	4	10	10	10	11	11	4		

Note: The number of sessions includes special activities, waxing workshops, etc. The time allocated to a session does not include supervised ski play time or the social time scheduled at the end each activity/practice.







5.1.4 Seasonal Plan Worksheet

Sample chart for a Level 3 Jackrabbit Group (children approximately 8 years of age)

	Mid-October/snow	December	January	February	March
Pre-Ski Season Practice Sessions (hiking; games; canoeing)	11 Sessions				
Special Classroom Practice Sessions (ski preparation; winter safety)	Ski Preparation Session Practice Plan 12	Winter Safety Session Practice Plan 13			
Skill Development Camp (on-snow) (see section 7.2 of your CCI-L2T (Dryland) Reference Material)		Christmas Holiday Ski Camp (overnight camp with club athletes - Fundamentals Level 4 and Learning to Train) Practice Plans 20, 21			
Special On-Snow Activities (Orienteering Poker Ski; Backwoods Adventure; Christmas Activity)		Christmas Activity (classic technique) Practice Plan 16	Backcountry Adventure Practice Plan 30	Downhill Games Sprint Games Modified Ski Tournament Practice Plans 36, 37, 32	





	Mid-October/snow	December	January	February	March
Club Activities	Ski Swap				Year-End Club Wind-Up (with costume races)
Classic Technique Practice Sessions		3 sessions	4 sessions	3 sessions	
Skating Technique Practice Sessions		2 sessions	3 sessions	3 sessions	
Up/Down Technique Practice Sessions			See regular practice sessions	See Downhill Games	
Competitions (see sections 2.4 and 8)			Club Team Relay event using terrain park (classic technique) Regional Cup held at home club venue (interval start; free technique)	Ski Tournament (classic technique; relay, sprint, interval start)	Costume Races (free technique) (refer to club activities)
Others (Year-End Skills Evaluation, etc.)				1 session	4 sessions





Seasonal Plan Worksheet (working copy)

Sample chart for a Level 3 Jackrabbit Group (children approximately 8 years of age)

	Mid-October/snow	December	January	February	March
Pre-Ski Season Practice Sessions (hiking; games; canoeing)					
Special Classroom Practice Sessions (ski preparation; winter safety)					
Skill Development Camp (on-snow) (see section 7.2 of your CCI-L2T (Dryland) Reference Material)					
Special On-Snow Activities (Orienteering Poker Ski; Backwoods Adventure; Christmas Activity)					





	Mid-October/snow	December	January	February	March
Club Activities					
Classic Technique Practice Sessions					
Skating Technique Practice Sessions					
Up/Down Technique Practice Sessions					
Competitions (see sections 2.4 and 8)					
Others (Year-End Skills Evaluation, etc.)					





5.2 Designing a Practice Plan

This section will help you develop your own comprehensive practice plans, and to coordinate those plans in the context of an overall plan for the season.

Note that the practice plans provided are fully integrated with the FUNdamental Skill Criteria and FUNdamental Skills Checklists outlined in section 4.3. Use these plans as a guideline only. They are sample plans to be used as a starting point for the development of your own plans. If this is your first year coaching you may wish to follow the plans closely, but as you become more experienced you will learn to adapt them to suit your situation. For example, some groups of skiers will progress through the program at a faster or slower pace than others, or your ski area will work better with some games than others. And don't forget that the plan you develop for your group needs to fit in with the overall program plan determined by your SDP Programmer and your club.

Skill development sessions for children in the FUNdamentals stage of development are broken down into four levels (Levels 1 to 4). Level 1 is generally used for children six years of age, Level 2 for children seven years of age, etc.

Points to keep in mind:

- The indoor sessions can be held before the snow season begins, or they can be used to substitute for regular sessions during the winter in the event of cancellation due to lack of snow or weather that is too cold or too wet.
- Ideally, the ski preparation workshop should be held prior to the snow season.
- The ski playground area should be set up before the session begins and prepared for the age and skill level of the skiers using it.
- Each practice session is a specified length of time that is appropriate for the age of the child, followed by 20 minutes of supervised “play time”. An additional ten to fifteen minutes should be scheduled for hot chocolate and snacks at the day lodge.
- Skiers should come to the practice session prepared. Time needed to wax skis, put on ski equipment or change clothes is in addition to the time allocated for the lesson.
- Poles will be required when learning some skills, whereas they will not be required for others.
- If you are coordinating a school program and the ski equipment does not belong to the skier, the practice session should not end until the skis are prepared for storing (socks for both tips and tails; proper ties) and have been put away.
- Encourage the education of the skiers. DO NOT do everything for them. Progressively develop their ability to look after themselves.





- ❑ Definition: a “Fall Line” is the direction water would flow, or a ball would roll down a hill.

Tips for games:

It is important to include the occasional “co-operative” game or task in the practice sessions. With this type of game there is more than one winner or winning team - everyone can win. Following are some suggestions to make games more cooperative:

- ❑ Select activities that encourage team work, or adapt them for that purpose. An example would be to make a “rule” that everyone on the team must touch the ball before the team can score.
- ❑ Keep everyone active and involved. It is not necessary to have goalies in a scoring game. Another example would be human musical chairs (with parents and coaches as the chairs), where all the children could continue to play the game as the “chairs” are eliminated. In this case, everyone can try and sit on the last chair together.
- ❑ Point totals can be left out of scoring games. Make team scores meaningless by having children change teams after they score; eventually most participants will have played on both teams and there won't be a clear winning team.
- ❑ Encourage personal improvement or team improvement. For example, a relay team can be encouraged to beat their own best performance (fewest strides etc.), rather than to beat another team.

Teaching components:

- ❑ **Skill Introduction:** A new skill is being introduced that is either a completely new skill or a known skill that must be executed at a higher standard.
- ❑ **Skill Reviewed and Introduced:** New progressions for a skill that has already been introduced. To save space, the key instructional points only refer to the new progression.
- ❑ **Skill Review:** All progressions for the particular skill have been previously introduced and to save space the key instructional points have not been repeated. The exception is when the previous skill level is being reviewed for the first time.
- ❑ **Common Errors:** To save space, common errors are only used when referring to new progressions being introduced.

5.2.1 Introducing Pre-Ski Season Activities

Pre-ski season activities should be introduced when a child is eight years of age (Level 3). At this age, the sessions should begin in mid-October.





Benefits of Pre-Ski Season Practice Activity

- It can provide a positive introduction to activities that promote physical fitness.
- It is a team builder.
- It encourages friendships among children with similar lifestyles and interests.
- It makes your recruiting program more competitive with other winter sports that start up early in the fall.

Tips For a Successful Pre-Ski Season Practice Session

- It must be a group activity!
- It must be well planned!
- It must offer variety and challenge!
- It must incorporate learning into games!
- It must bring adventure into fitness development activities!
- It must be considerate of the age and ability of the participant!

Suitable Activities

Sessions will vary considerably according to the age of the participants and the objectives of the program. Activities may include a hike, a road bike tour, a soccer game, or more adventure-based activities such as a day hike to a forestry lookout, a camp-out in a nearby park, canoeing on a lake, learning to use a kayak, or an orienteering session.

5.2.2 Sample Pre-Ski Season Practice Plans

The following pages present three examples of practice plans for the pre-season period:

1. Example 1: A Hike
2. Example 2: Games
3. Example 3: Orienteering for Treasure





EXAMPLE 1: A HIKE

Ensure the parents are informed in advance as to your expectations regarding clothing, footwear and fluid replacement for the participants. Plan a hike that will take a total of one to one and a half hours of walking. Include interesting points along the route, such as a beaver pond. Have a special activity planned for the middle or the end of the hike, such as a campfire with hot dogs and marshmallows, or a game followed by refreshments.

Specific Objectives:

- 1) Introduce children to FUN outdoor activities that lead to general fitness.
- 2) Develop a “ team”.
- 3) Have FUN!
- 4) Introduce the importance of bringing fluids on a hike.

Key Teaching Points:

- At this time of year, be aware of the weather and ensure that the children are dressed appropriately.
- Encourage the children to take drinks every 10-15 minutes.
- At the start of the hike, some of the group may wish to run. A version of the “Tortoise and the Hare Story” might make an effective deterrent. Try to shift their attention to looking for birds’ nests or collecting bright leaves.
- Stretching:
 - ✓ Undertake joint rotational circles slowly (arm circles, hip circles, etc.).
 - ✓ Static stretches are held for at least five seconds.
 - ✓ Common errors:
 - rotational exercises are done too quickly.
 - bouncing on the static stretches.

Teaching Aids Needed:

- Help from parents and other coaches.
- Map of the route for each of the adults.
- Refreshments/lunch.
- One or two first aid kits, depending on the size of the group.
- Fluids and high energy foods.





Skill	Description	Time
Warm Up	Follow the Leader: Have the children follow the coach, who uses features in the rendezvous area to create an obstacle course. The coach jogs slowly around, jumping over logs, balancing on logs, etc. If no suitable obstacles exist, the coach can run backwards, sideways, hop with one leg or both legs, somersault, run fast, run slow. The coach should change directions frequently.	5 min.
Stretching	<ol style="list-style-type: none">1) Coach leads slow rotational exercises (head, shoulders, hips, knees and ankles).2) Coach demonstrates a static stretch. The children try it, holding for five seconds. No bouncing. They should stretch as much as they can without pain. Relax and repeat.3) Coach demonstrates another stretching exercise.	5 min.
Hike	Coach ensures children are drinking fluids and talks to each of them on a one-on-one basis.	60 - 90 min.





EXAMPLE 2: GAMES:

Plan a practice session with a focus on games. Be creative!

Specific Objectives:

- 1) Introduce children to FUN outdoor activities that lead to general fitness.
- 2) Develop a “ team”.
- 3) Have FUN!
- 4) Develop motor coordination.

Teaching Aids Needed:

- Help from parents and other coaches.
- One or two soccer balls; a handball.
- Refreshments.

Skill	Description	Time
Warm Up	Follow the Leader: Have the children follow the coach, who uses features in the practice area to create an obstacle course. The coach jogs slowly around, using playground equipment, etc. If no suitable obstacles exist, the coach can run backwards, sideways, hop with one leg or both legs, somersault, run fast, run slow. The coach should change directions frequently. If time permits, have the skiers perform their own “Funny Walk”!	10 min.
Stretching	<ol style="list-style-type: none"> 1) Coach leads slow rotational exercises (head, shoulders, hips, knees and ankles). 2) Coach demonstrates a static stretch. The children try it, holding for five seconds. No bouncing. They should stretch as much as they can without pain. Relax and repeat. 3) Coach demonstrates another stretching exercise. 	5 min.





Game Time	Red Light, Green Light: The coach is the policeman. He/she stands at one end of the field. The children stand in a line at the other end of the field facing the policeman. When the policeman yells “green light”, they walk or run forward. When the policeman yells “red light” the children balance on one leg like a plane (lean forward, arms stretched out to side, and free leg stretched back). If children move or lose their balance on the red light, they have to return to the start. Alternate left and right legs. A variation to the game is to have the children balance like a flamingo (upright, knee bent in front).	5 min.
Game Time	Modified Team Handball: Have the children divide into two teams. The objective of the game is to score by rolling the handball through a net. The ball is transferred from one team member to the other by throwing it. Players cannot run with the ball or kick it. To score, everyone on a team must touch the ball without the other team touching it. At this age level the coach needs to keep track of who has touched the ball.	15 min.
Game Time	Team Juggling: Make a circle with everyone facing towards the centre. The children throw a ball to each other in such a manner that it is easy to catch. The child throwing the ball must call the name of the person that the ball is being thrown to. Everyone catches the ball once before the first person touches it again. Repeat 1-2 times with the ball going around the group in the same order. If the group can do this without dropping the ball, introduce a second ball, and then a third. Find out how many balls the group can handle.	5 min.
Game Time	Zim, Zam, Zoom: Have the children form a circle, facing in. The coach is in the middle. Going around the circle, everyone says their name clearly, one at a time, so that everyone can hear it. The coach then points at a child and says “Zim”, “Zam” or “Zoom”.	5 min.





	<p>If the coach says “Zim”, the skier they pointed to has to say the name of the skier on their right; if “Zam”, they have to say the name of the skier on their left; if “Zoom”, they have to say their own name. If the skier makes a mistake or hesitates too long, they have to switch places with the coach.</p>	
Game Time	<p>Soccer: Play the game with or without goalies. If the game is played without goalies, the scorers should switch teams.</p>	20 min.
Game Time	<p>Simon Says: This is the old game where the one who gets caught becomes Simon and that individual continues by trying to trick someone else. If Simon says “Simon says” first, - e.g., “Simon says: touch your toes” or “Simon says: twist at the waist” - the group should follow the instructions. However, if Simon says simply “clap your hands” without saying “Simon says: clap your hands”, no one should clap their hands.</p>	5 min.
Wrap Up	<p>Conclude the session with juice, snacks and a short social time.</p>	5 min.





EXAMPLE 3: ORIENTEERING FOR TREASURE:

This session will require advance planning and preparation. For detailed instructions refer to “Games for Teaching Technique” (section 4.3.9).

Specific Objectives:

- 1) Introduce children to FUN outdoor activities that lead to general fitness.
- 2) Develop a “ team”.
- 3) Review the importance of bringing fluids on an outdoor excursion.
- 4) Have FUN!
- 5) Introduce the concept of relay exchanges.

Key Teaching Points:

- Ensure the group stays together at all times.
- Encourage the children to take drinks every 10 to 15 minutes.
- Ensure the participants take turns “reading” the map. Provide assistance only if the frustration level is getting too high or the children misinterpret the drawing.

Teaching Aids Needed:

- Help from parents and other coaches.
- Enough maps for each team, at each station. Maps would include pictures of lamp posts, playgrounds, slides, sandboxes, ponds, dead trees, big trees, logs, outhouses, etc.
- Packing tape for taping maps to bottoms of slides and other locations.
- Baggies to put maps in if inclement weather is expected.
- Six ropes, each two metres in length, to mark exchange zones.
- A first aid kit.
- Fluids and high energy foods.





Skill	Description	Time
Warm Up	<p>Follow the Leader: Have the children follow the coach, who uses features in the practice area to create an obstacle course. The coach jogs slowly around, using playground equipment, etc. If no suitable obstacles exist, the coach can run backwards, sideways, hop with one leg or both legs, somersault, run fast, run slow. He/she should change directions frequently. If time permits, have the skiers perform their own “Funny Walk”!</p>	10 min.
Stretching	<ol style="list-style-type: none"> 1) Coach leads slow rotational exercises (head, shoulders, hips, knees and ankles). 2) Coach demonstrates a static stretch. The children try it, holding for five seconds. No bouncing. They should stretch as much as they can without pain. Relax and repeat. 3) Coach demonstrates another stretching exercise. 	5 min.
Game Time	<p>Treasure Hunt: As per the description in section 4.3.9.</p>	60 min.
Wrap Up/ Fluids	<p>Coach asks participants how thirsty they became during the orienteering session to lead into a brief information session explaining the importance of taking fluids with them when they are physically active, year round. Emphasize which fluids are suitable and which are not suitable. Conclude the session with juice, snacks and a short social time.</p>	5 min.





5.3 Practice Plans: FUNdamentals Stage of Development – Level 1

Points to keep in mind in addition to those listed in section 5.2:

- The program should offer a minimum of 16 sessions, two per week, over a period of eight weeks. However, if snow is available, it would be preferable to offer the program for 12 weeks (24 sessions), beginning in early December. This would include two practice sessions a week plus special activities in addition to those already scheduled in the plan for the season.
- The indoor sessions can be held before the snow season begins, or they can be used to substitute for regular sessions during the winter in the event of cancellation due to lack of snow or weather that is too cold or too wet.
- The ski playground area should be set up before the session begins and prepared for the age and skill level of the skiers using it.
- Ideally, the ski preparation workshop should be held prior to the snow season.
- Each practice session is a total of 60 minutes, followed by 20 minutes of supervised “play time” at the ski playground. An additional ten minutes should be scheduled for hot chocolate and snacks at the day lodge.
- Skiers should come to the practice session prepared. In the following section the time needed to wax skis, put on ski equipment or change clothes is intended to be in addition to the time allocated for the practice session.
- In general, poles should not be used when these skills are introduced.
- All the sessions will focus on classic technique.
- If you are coordinating a school program and the ski equipment does not belong to the skier, the practice session should not end until the skis are prepared for storing (socks for both tips & tails; proper ties), and have been put away.
- Encourage the education of the skier. DO NOT do everything for them. Progressively develop their ability to look after themselves.
- Definition: the “fall line” is the direction water would flow, or a ball would roll, down a hill.





PRACTICE PLAN 1 (LEVEL 1 – ON SNOW)

Specific Objectives:

- 1) Develop and improve the skier's balance and agility – necessary if the skier is to progress to more advanced techniques.
- 2) Introduce Falling and Rising on flats.
- 3) Introduce Ready Position on flats – a fundamental position used in many ski techniques.

Key Teaching Points:

Falling on Flats

- ✓ Falls to side and back using sitting motion.
- ✓ Common error:
 - falls forward.

Rising on Flats

- ✓ Brings skis together, side by side and under the body.
- ✓ Gets skis flat on snow by moving onto hands and knees.
- ✓ Slides one ski forward so foot is flat on ski.
- ✓ Common errors:
 - tries to stand up before skis are parallel.
 - tries to stand up without hips over skis.

Ready Position

- ✓ Arms and hands stay forward of body.
- ✓ Skis parallel to each other.
- ✓ Knees and ankles slightly bent.
- ✓ Upper body is relaxed and slightly forward.
- ✓ Common errors:
 - hands are at side of body at hips.
 - upper body leaning too far forward, or too upright and stiff.
 - ankles and knees are straight and/or locked.

Teaching Aids Needed:

- Ski playground area set up appropriately for age and skill level of the skiers.
- Labels or masking tape and marker to identify skiers.





Skill	Description	Time
Ski Play (to warm up)	Varied speeds.	5 min.
Balance (Introduce)	Have skiers stand in a circle. Stork Stance: Have skiers stand on left ski only. Have skiers stand on right ski only.	2 min.
	Tippy Toes: Have skiers rock forward onto their toes and backwards onto their heels, then try to find the best balance point. Skiers do the “teeter-totter” back and forth.	2 min.
	Reach for the Sky: Have skiers reach for the sky, going up on their toes and then settling back equally on both feet.	2 min.
Ready Position (without poles) (Introduce)	<ol style="list-style-type: none"> 1) Coach demonstrates and goes over key points. 2) Have skiers go into Ready Position. 3) Have skiers bend ankles and knees. Move around the circle and give skiers a gentle nudge to check their balance. 4) Have skiers straighten ankles and knees and give skiers a gentle nudge again. Let them feel which position is best for balance. 5) Repeat each several times and help skiers refine their positioning. 6) For additional details refer to section 4.3.1. <p>Soldiers: Have skiers stand tall, with locked knees and straight back – “ATTENTION”. Have skiers relax, bending their knees and leaning slightly forward – “AT EASE”. Repeat several times.</p>	5 min.
Rising on Flats (without poles) (Introduce)	<ol style="list-style-type: none"> 1) Coach demonstrates and goes over key points. 2) Have skiers get onto knees with hands on skis and get up into Ready Position. 3) Have skiers lie on their right side. Get into kneeling position and then up into Ready Position. 4) Repeat on left side. 5) Repeat several times. 6) For additional details refer to section 4.3.1. 	10 min.





<p>Falling on Flats (Introduce)</p>	<ol style="list-style-type: none"> 1) Coach demonstrates and goes over key points. 2) Have skiers fall to the right using sitting motion. 3) Repeat on left. 4) For additional details refer to section 4.3.1. 	<p>10 min.</p>
<p>Game Time</p>	<p>Falling Tag: Coach is “it”. Coach chases skiers around field. Once tagged, skiers must fall down. Skiers are back in game when they stand up.</p>	<p>10 min.</p>
<p>Balance and Agility (Introduce)</p>	<p>Flea Leaps: Have skiers leap off snow, keeping their knees flexed when landing.</p> <p>Snakes: This game is also known as “Follow the Leader”. The skiers follow one of the coaches, who moves slowly through the ski playground, changing directions frequently.</p>	<p>15 min.</p>
<p>Ski Play</p>	<p>Skiers explore ski playground area under supervision of the coaches. Coaches can provide some one-on-one instruction.</p>	<p>20 min.</p>

Conclude the session with hot chocolate, snacks and a short social time at the day lodge.



**PRACTICE PLAN 2 (LEVEL 1 – ON SNOW)****Specific Objectives:**

- 1) Review Ready Position, Falling and Rising on flats.
- 2) Introduce Star Turn - tails together.
- 3) Introduce Diagonal Stride on flats without poles.
- 4) Review how to hold a ski pole.

Key Teaching Points:**☐ Star Turn**

- ✓ Stands in Ready Position.
- ✓ Forms slight wedge with tips apart and tails together.
- ✓ With weight on first ski, lifts tip of second ski and widens wedge 20-30 cm.
- ✓ Puts weight on second ski and brings first ski parallel.
- ✓ Repeat until full circle is made.
- ✓ Common errors:
 - skier keeps centre of gravity between the skis.
 - skier steps on tail of other ski.

☐ Diagonal Stride on Flats (without poles)

- ✓ Skier walks on skis, pushing off with the back ski and sliding a bit on the front ski.
- ✓ Common error:
 - skier keeps both skis flat on snow throughout the movement.
 - skier can't slide the ski.

Teaching Aids Needed:

- ☐ Ski playground area set up appropriately for the age and skill level of the skiers.
- ☐ Coloured plates or numbers for the clock.
- ☐ Special feature – a tunnel made of hoops or ski poles or similar suitable material.

Skill	Description	Time
Ski Play (to warm up)	Varied speeds.	5 min.





<p>Rising and Falling on Flats (without poles) (Review)</p>	<ol style="list-style-type: none"> 1) Review key points on Rising and Falling. 2) Have skiers lie on their backs; on signal, rise up to the Ready Position as quickly as possible. 3) Repeat several times. 4) Review how to put on a ski pole. The ski poles are then set aside for the remainder of the session. 	<p>5 min.</p>
<p>Balance (Introduce and Review)</p>	<p>Marching Soldiers: Have skiers walk on one spot lifting the knee high in front of chest.</p> <p>Tail Lifts: Have skiers walk on one spot extending the leg backwards. See if they can lift the skis off the ground.</p> <p>Flea Leaps: Have skiers jump off snow with both feet. Keep knees bent when landing.</p> <p>One-Leg Pops: Have skiers jump off snow from one ski to the other.</p> <p>Repeat each exercise several times.</p>	<p>10 min.</p>
<p>Diagonal Stride on Flats (without poles) (Introduce)</p>	<ol style="list-style-type: none"> 1) Coach demonstrates and goes over key points. 2) Have the skiers cross the area sliding their skis. 3) Have the skiers get on the balls of their feet and walk forward. 4) Have the skiers cross the area sliding their skis and pushing off the balls of the feet using a “jogging-like” action. 5) Ask them to use a certain number of steps to get from one point to another. Bring the number down as they improve. 6) For additional details refer to section 4.3.1. 	<p>10 min.</p>





Game Time	British Bulldog: The group stands on one side of the ski area. One skier stands in the middle. At the signal of the coach, the group crosses to the other side. The skier in the middle must tag them. Skiers who are tagged remain in the centre to help.	10 min.
Star Turn (tails together) (Introduce)	<ol style="list-style-type: none">1) Coach demonstrates and goes over key points.2) Skiers walk on spot, lifting tips of skis only.3) Skiers lift tip on one ski and form a wedge. Skiers stand on “wedge” ski and bring other ski parallel. Go back to original position. Do this slowly to emphasize balance and weight transfer.4) Make a complete turn.5) For additional details refer to section 4.3.1.	10 min.
Game Time	Clock: Split into groups of three or four. Each team has two “clocks” in front of them, each about 10 metres apart. Each clock is the size of the perimeter of a Star Turn. Each clock has a number (1-4. at each quarter. A skier advances into a circle and is told to point his/her tips at different numbers (i.e. using the Star Turn). The skier moves to the next clock as fast as possible and the following skier moves into the first clock. The number commands are repeated. Then the first skier returns to the start without interfering with the others, etc. Can use colors instead of numbers.	10 min.
Ski Play	Skiers use the ski playground under supervision of the coaches. Some one-on-one instruction can take place.	20 min.

Conclude the session with hot chocolate, snacks and a short social time at the day lodge.





PRACTICE PLAN 3 (LEVEL 1 – INDOORS)

SKI PREPARATION SESSION

Specific Objectives:

- 1) Introduce young skiers to good ski equipment management.
- 2) Introduce a basic wax kit.
- 3) Teach skiers that good ski-care habits and appropriate ski preparation will result in positive ski experiences.

Key Teaching Points:

- Ski Care.** The coach reviews the principles of good ski care:
 - ✓ Put your name on your equipment (if applicable).
 - ✓ How to carry your ski equipment.
 - ✓ Don't ski where there is gravel or dirt.
 - ✓ Don't leave your ski poles lying around where someone can step on them.
 - ✓ Place your equipment in the appropriate place when you go into the day lodge.
 - ✓ Store your equipment properly after each session; put socks over the tips and tails; use ski fasteners to hold the skis firmly together, etc.
 - ✓ Learn to prepare your own skis; don't wait for an adult to do it.
- Wax Kit.** The coach introduces the contents of a basic wax kit.
- Ski Preparation**
 - ✓ The first step is inspection. Have the skier hold the ski up to the light and look down the base. Have them look for bumps, tears, etc.
 - ✓ Have the skier place the ski firmly in the ski form.
 - ✓ Have the skier clean the ski top, sides and bottom with wax remover.
 - ✓ Dry thoroughly.
 - ✓ Using a plastic scraper, make a couple of passes from tip to tail in a continuous motion.
 - ✓ Take some fiberlene or paper towel and wipe the ski.
 - ✓ The ski is now ready to wax.
 - ✓ The coach should check the ski to see if the ski needs work, and either repair the ski or inform the parent if it needs special attention.





Teaching Aids Needed:

- A suitable room to hold a ski preparation session.
- An appropriate number of coaches/parents to provide close supervision.
- Ski forms and supplies of tools, etc.
- A sample FUNdamentals wax kit.
- Refer to sections 3.5 of the Introduction to Community Coaching Reference Material and section 7 of this document for additional information.

Conclude the session with hot chocolate and snacks.

Ensure adequate supervision for all ski preparation sessions!





PRACTICE PLAN 4 (LEVEL 1 – ON SNOW)

Specific Objectives:

- 1) Review Falling, Rising and Star Turn.
- 2) Introduce and review Diagonal Stride on flats.
- 3) Diagonal Stride on flats.
- 4) Introduce Falling while moving.

Key Teaching Points:

Herringbone on Flats

- ✓ Creates and maintains small “V” with skis.
- ✓ Edges ski when moving from ski to ski.

Falling on Flats

- ✓ Skier falls to the side and back in a sitting position.
- ✓ Common errors:
 - skier does not move into the sitting position before falling.
 - skier falls forward.

Diagonal Stride on Flats

- ✓ Skier slides a ski forward.
- ✓ While skier pushes ski back, he/she is transferring weight to gliding ski.
- ✓ After weight is transferred to gliding ski, the pushing ski momentarily comes off the snow at the end of the push.
- ✓ Common errors:
 - poor balance.
 - skier can't lift ski off snow.
 - back ski doesn't lift off snow.

Teaching Aids Needed:

- Ski playground area set up appropriately for the age and skill level of the skiers.
- Balls in an old sock. Knot the sock so the ball doesn't come out. Ideally one for each skier.
- A target or basket.
- One soccer ball.
- Coloured water or another suitable marker.





Skill	Description	Time
Ski Play (to warm up)	Varied speeds.	5 min.
Balance (Review)	<ol style="list-style-type: none">1) Have skiers run in place on their skis, changing the tempo from slow to fast.2) Have skiers walk on one spot extending their leg backwards.3) Have skiers balance on one leg with the other extended backwards. Hold that position for three seconds and then switch. <p>Sizzling Snow: While remaining in one place, the skiers step from ski to ski, keeping only one ski on the burning snow at a time. Have the skiers “hiss” as the snow “burns their skis”.</p>	5 min.
Diagonal Stride on Flats (without poles) (Review)	<ol style="list-style-type: none">1) Coach demonstrates and reviews key points.2) Skiers cross the area sliding their skis in a “jogging-like” action, pushing off the balls of their feet, and lifting the ski off the snow at the back. Skiers should continue the glide on the front ski.3) For additional details refer to section 4.3.1.	10 min.
Star Turn (tails together) (Review)	<ol style="list-style-type: none">1) Coach demonstrates and reviews key points.2) Skiers form wedge and make circles in both directions.3) Skiers repeat the above, but keep the tips together and tails apart.4) For additional details refer to section 4.3.1.	5 min.





<p>Herringbone on Flats (Introduce)</p>	<ol style="list-style-type: none"> 1) Coach demonstrates and goes over key points. 2) Skiers create a small “V” with their skis. 3) Skiers edge one ski while stepping onto the other ski. 4) Skiers move forward using first one ski and then the other, keeping the tails of skis close together and the tips apart. 5) For additional details refer to section 4.3.1. 	<p>5 min.</p>
<p>Game Time</p>	<p>Fetch: Coach throws several socks (with balls in them) in all directions. Skiers fetch them and return them. Try to provide a ball for each skier. Throw: Skiers ski up to a target and throw the sock/ball at it. If they miss, they have to do a Star Turn.</p>	<p>10 min.</p>
<p>Falling on Flats (while moving) (Review and Introduce)</p>	<ol style="list-style-type: none"> 1) Coach demonstrates and goes over key points. 2) Skiers fall to the side and back in a sitting position. 3) Colour a couple of bright spots on both sides of the track. Skiers fall on the spot while skiing by. 	<p>5 min.</p>
<p>Balance</p>	<p>Freeze and Glide: Skiers take four or five strides, freeze on one leg and glide to a stop.</p>	<p>5 min.</p>
<p>Game Time</p>	<p>Soccer: Use more than one ball. No goalies.</p>	<p>10 min.</p>
<p>Ski Play</p>	<p>Skiers use the ski playground under supervision of the coaches. Coaches provide some one-on-one instruction.</p>	<p>20 min.</p>

Conclude the session with hot chocolate, snacks and a short social time at the day lodge.



**PRACTICE PLAN 5 (LEVEL 1 – ON SNOW)****Specific Objectives:**

- 1) Develop and improve skier's balance and agility.
- 2) Review Herringbone on Flats.
- 3) Introduce Side Stepping on flats.

Key Teaching Points: **Side Stepping on Flats**

- ✓ Body in Ready Position.
- ✓ Skier balances on one ski, steps sideways with the other leg, balances on this leg, brings first leg parallel. Repeat.
- ✓ Steps in both right and left directions.
- ✓ Common errors:
 - skier doesn't keep the skis parallel - steps on the other ski.

Teaching Aids Needed:

- Ski playground area set up appropriately for the age and skill level of the skiers.
- Five ropes two metres in length, preferably coloured.
- Coloured water, pylon, target.

Skill	Description	Time
Ski Play (to warm up)	Varied speeds.	5 min.
Balance (Review)	<ol style="list-style-type: none"> 1) Have skiers balance on one leg with the other extended backwards. Hold the position for three seconds, then switch. 2) Have the skiers try this exercise moving their leg to the side and also the front. 3) Repeat with both legs several times. <p>Sizzling Snow: While remaining in one place, the skiers step from ski to ski, keeping only one ski on the burning snow at a time.</p>	5 min.





<p>Diagonal Stride on Flats</p>	<ol style="list-style-type: none"> 1) Coach demonstrates and reviews key points. 2) Skiers cross the area sliding their skis. 3) Skiers cross the area “jogging” and gliding their skis, lifting the ski off the snow after they push off the balls of their feet with the back ski. 4) For additional details refer to 4.3.1. 	<p>10 min.</p>
<p>Side Stepping on Flats (Introduce)</p>	<ol style="list-style-type: none"> 1) Coach demonstrates and goes over key points. 2) Arms and hands slightly forward and out to side for balance. 3) Skiers put weight on one ski and step with the other leg sideways. Skiers shift weight onto second ski and bring the first ski parallel to the second. Repeat. 4) Keep skis parallel. 5) For additional details refer to 4.3.1. 	<p>5 min.</p>
<p>Balance and Agility</p>	<ol style="list-style-type: none"> 1) Coach places five ropes one metre apart. 2) One skier side steps over each rope, then skis around a pylon and returns to the start. 3) The next skier begins when first skier is on the 4th rope. 4) When all skiers have completed the exercise, repeat in the other direction. 5) Now lay the ropes two metres apart. 6) In turn, skiers Side Step left over the first rope, do a half a Star Turn to the left, then Side Step right over the second rope, and complete half a Star Turn to the right. Etc. 	<p>10 min.</p>
<p>Game Time</p>	<p>Mines: Spray coloured water dots on various places in the track, but don't spray left and right tracks at the same place. The skier skis down the track and lifts the ski over the “mine” while gliding on the other ski.</p>	<p>10 min.</p>





Balance	Freeze and Glide: Skier takes four or five strides, freeze on one leg and glide to a stop. Repeat.	5 min.
Game Time	Freeze Tag: One coach acts as “chaser”. Skiers freeze on one leg when they are tagged. Frozen skiers may be unfrozen if tagged by a free skier.	10 min.
Ski Play	Skiers use the ski playground under supervision of the coaches. Coaches provide some one-on-one instruction.	20 min.

Conclude the session with hot chocolate, snacks and a short social time at the day lodge.





PRACTICE PLAN 6 (LEVEL 1 – ON SNOW)

SPECIAL ACTIVITY

Participation in a club activity/event exposes young skiers and their families to the wide range of programs that clubs offer, as well as the family orientation of the sport. If you live in a community that doesn't offer programs of this kind, refer to section 5.5 in the Introduction to Community Coaching Reference Material for some ideas and create a "special activity" of your own.

Specific Objectives:

- 1) Introduce young skiers to the club at large.
- 2) Practice techniques learned during regular practice sessions.
- 3) Have fun.

Key Teaching Points:

- Provide coaching suitable for the activity that has been selected.
- No formal technique instruction.
- Use opportunities for one-on-one technique instruction.

Conclude the session with hot chocolate and snacks at the day lodge. Extend the supervised activity time in the day lodge as appropriate.





PRACTICE PLAN 7 (LEVEL 1 – ON SNOW)

Specific Objectives:

- 1) Develop and improve skier's balance and agility.
- 2) Review Falling on Flats and introduce Rising on a Slope.
- 3) Introduce Star Turn on a hill.
- 4) Introduce Free Glide.

Key Teaching Points:

Rising on a Slope

- Skis brought together, side by side and under the body, perpendicular to the fall line.
- Skier moves onto hands and knees.
- Skier edges skis and stands up.
- Common errors:
 - ✓ skier does not move skis downhill of body before attempting to get up.
 - ✓ skier does not edge skis to prevent slipping down hill.

Star Turn on a Hill

- ✓ This technique helps the skier get set up before going down a hill.
- ✓ Skier plants poles downhill of skis, and weights poles.
- ✓ Using Star Turn, skier moves skis parallel to direction of hill (the fall line), keeping weight on poles.
- ✓ Common errors:
 - skier does not weight poles.

Free Glide

- ✓ Skier stands with hands forward, skis parallel.
- ✓ Skier has pole handles down and in front of body, pole tips pointed behind.
- ✓ Common errors:
 - skier stands too stiff and upright.
 - skier holds poles in awkward or dangerous position.





Teaching Aids Needed:

- ☐ Ski playground set up appropriately for age and skill level of skiers.

Beach ball for each skier in the group.

Skill	Description	Time
Ski Play (to warm up)	Varied speeds.	5 min.
Balance (Introduce)	Partner Pushes: Have half the skiers in the group remove their skis and slowly push another skier down the track. They need to push the skier's hips, first slowly and then at a faster speed. This gets the skier moving at speed without the intimidation of going down a hill. This game should be played on a packed area without ski tracks. Change around and repeat.	5 min.
Falling and Rising on Slope (Review/ Introduce)	<ol style="list-style-type: none"> 1) Coach demonstrates and reviews/introduces key points. This skill requires poles. 2) Have skiers bring skis together, side by side under the body on the downhill side of the body and perpendicular to the fall line (the path a ball would take to roll down a hill). 3) Have skiers move onto their hands and knees. 4) Have skiers edge their skis into the hill and stand. 5) Poles are moved parallel to the skis as the skier prepares to rise. 6) Have skiers get up the same as they would on a flat area. 7) "Rising on a Slope" flows into "Star Turn on a Slope". 	10 min.
Game Time	Ball Juggling: Have the skiers move along the snow while throwing a beach ball in the air and catching it. Ask the skiers to work with a partner passing the ball back and forth as they move forward on their skis.	5 min.





<p>Star Turn on a Hill (Introduce)</p>	<ol style="list-style-type: none">1) Coach demonstrates and reviews key points.2) Have skiers stand perpendicular to the fall line on a slope.3) Skiers plant poles downhill of skis, and weight poles.4) Skiers turn to face downhill using the Star Turn, and moving skis parallel to the fall line (facing down the hill). Weight remains on poles.5) Skiers remove weight from poles and glide down the slope.	<p>15 min.</p>
<p>Free Glide on Slope (Introduce)</p>	<ol style="list-style-type: none">1) Coach demonstrates and reviews key points while standing on a flat area, then moves to top of slope.2) Skiers stand in Ready Position (body generally upright, knees and ankles relaxed and slightly bent).3) Skiers keep hands forward and skis parallel.4) Pole handles are down and in front of body, with pole tips pointed behind. The pole shaft is angled down and backward so that it doesn't drag on the snow.	<p>10 min.</p>
<p>Game Time</p>	<p>Slide Tall and Slide Small: Skiers descend a slight incline, exerting pressure on the tongues of their boots and bending their legs slightly. Alternate between putting a lot of pressure on the boot tongues (slide small) and a little pressure on the boot tongues (slide tall).</p>	<p>10 min. (if time allows)</p>
<p>Ski Play</p>	<p>Ski playground under supervision of the coaches. Coaches provide some one-on-one instruction.</p>	<p>20 min.</p>

Conclude the session with hot chocolate, snacks and a short social time at the day lodge.





PRACTICE PLAN 8 (LEVEL 1 – INDOORS)

DRESSING APPROPRIATELY FOR SKIING

Specific Objectives:

- 1) Teach young skiers how to dress for skiing.
- 2) Have skiers practise dressing in layers.
- 3) Teach skiers the characteristics of clothing materials.

Teaching Aids Needed:

- A classroom or similar room.
- A complete lesson plan is available in section 3.2 of the Introduction to Community Coaching Reference Material.
- Clothing as outlined in the lesson plan.

Conclude the session with hot chocolate and snacks.



**PRACTICE PLAN 9 (LEVEL 1 – ON SNOW)****Specific Objectives:**

- 1) Develop and improve skier's balance and agility.
- 2) Review Rising on a Slope.
- 3) Review Free Glide.

Teaching Aids Needed:

- Ski playground set up appropriately for the age and skill level of the skiers.
- Special feature – gentle roller-coaster dips.
- Bean bags, cones.

Skill	Description	Time
Ski Play (to warm up)	Varied speeds.	5 min.
Balance (Review)	<p>Pendulum Swings: Skiers stand on one leg while swinging the other leg back and forth. Begin slowly, and then increase the tempo.</p> <p>Combo Swing: Skiers stand on one leg while swinging the other leg back and forth. When the skiers stand on their left leg, the left arm swings in the same direction as the right leg and the right arm swings in the opposite direction.</p>	5 min.
Rising on a Slope (Review)	<ol style="list-style-type: none"> 1) Coach demonstrates and reviews key points. 2) Have skiers bring skis together side by side under the body on the downhill side of the body, and perpendicular to the fall line. 3) Skiers edge skis into the hill to prevent slipping. 4) Skiers get up the same way they would on flats. 	10 min.





<p>Game Time</p>	<p>Downhill Catch: Skiers try to touch the ground, and then lift their arms into the air while skiing down a slope. If they can achieve this, have them throw their mitt or a bean bag into the air and catch it while skiing down the slope. If they can achieve this also, the coach can throw a glove to them while they are coming down the hill to see if they can catch it and throw it back while they are moving.</p>	<p>10 min.</p>
<p>Free Glide (Review)</p>	<ol style="list-style-type: none"> 1) Coach demonstrates and reviews key points. 2) Skiers stand in Ready Position at top of slope. 3) Skiers keep their hands forward and skis parallel. 4) Pole shaft is pointed down and backwards without dragging on the snow. 	<p>10 min.</p>
<p>Game Time</p>	<p>Downhill Pairs: Skiers practise Free Glide on a slight downhill slope. The coach then sets up “start” and “finish” cones at the top and bottom of the slope, and breaks the group into teams of two for two-skier downhill races.</p>	<p>20 min.</p>
<p>Ski Play</p>	<p>Ski playground under supervision of the coaches. Coaches provide some one-on-one instruction.</p>	<p>20 min.</p>

Conclude the session with hot chocolate, snacks and a short social time at the day lodge.



**PRACTICE PLAN 10 (LEVEL 1 – ON SNOW)****Specific Objectives:**

- 1) Develop and improve skier's balance and agility.
- 2) Introduce Snowplow Braking.

Key Teaching Points: **Snowplow Braking**

- ✓ Use games to introduce edging needed for Snowplow Braking.
- ✓ Form wedge with ski tips together and tails apart.
- ✓ Control speed by braking - adjusting size of wedge and edging skis.
- ✓ Upper body maintains Ready Position.
- ✓ Common error:
 - skier cannot keep equal pressure on both skis.

Teaching Aids Needed:

- Ski playground set up for age and skill level of skiers.
- Bean bags, cones.

Skill	Description	Time
Ski Play (to warm up)	Varied speeds.	5 min.
Balance (Review)	Downhill Catch: Skiers try to touch the ground, and then lift their arms into the air while skiing down a slope. If they can achieve this, have them throw their mitt or a bean bag into the air and catch it while skiing down the slope. If they can achieve this also, the coach can throw a glove to them while they are coming down the hill to see if they can catch it and throw it back while they are moving.	10 min.





<p style="text-align: center;">Snowplow Braking (Review)</p>	<ol style="list-style-type: none"> 1) Coach demonstrates and reviews key points of Snowplow Braking on flat terrain. 2) Have skiers form wedge with ski tips together and tails apart. 3) Have skiers practise braking - adjusting size of wedge and edging skis. 4) Move group to slope and repeat exercise. 5) Have skiers control speed by adjusting the size of the wedge and edging their skis. The pressure on each ski should be equal, so that the skier does not turn to the left or right 6) Skiers maintain upper body in Ready Position while practising the skill. 7) The coach introduces the following games that reinforce the teaching points: Nibbles and Bites: Have skiers stand on flat area with skis parallel, in Ready Position. Have skiers try different degrees of edging, using both the left and right edges of their skis. Little “Nibbles” refers to a little edging. “Bites” refers to a lot of edging. Move the group to a slope when they have accomplished the skill on flat terrain. Ridges and Valleys: Have skiers stand in Ready Position on flat terrain, pushing one ski to the side and leaving a ridge at the farthest point away. Repeat with the other ski. The objective of the game is to create equal ridges with both the left and right skis. Stomp Fest: Have skiers stand in Ready Position and skid one ski sideways furiously and repeatedly to create a big ridge of snow. When the coach yells “change” (every few seconds), skiers switch to the other ski. The skier who creates the biggest snow pile wins the game. 	<p style="text-align: center;">15 min.</p> <p style="text-align: center;">5 min.</p> <p style="text-align: center;">5 min.</p> <p style="text-align: center;">5 min.</p>
---	---	--





Game Time	The coach places cones/poles as markers on the slope. Have skiers move down the hill slowly to the first set of markers, speed up between the first and second set of markers, and slow down between the second set of markers and the “finish line”.	10 min.
Ski Play	Ski playground under supervision of the coaches. Some one-on-one instruction.	20 min.

Conclude the session with hot chocolate, snacks and a short social time at the day lodge.





PRACTICE PLAN 11 (LEVEL 1 – ON SNOW)

Specific Objectives:

- 1) Develop and improve skier's balance and agility.
- 2) Review Snowplow Braking.
- 3) Introduce Diagonal Stride without poles.

Key Teaching Points:

Diagonal Stride (without poles)

- ✓ Weight is on free foot. Pushing down and back, transfer weight to gliding ski.
- ✓ Do it slowly.
- ✓ Put free foot beside or ahead of other foot.
- ✓ Common errors:
 - skier cannot balance on ski (weight isn't transferred).
 - skier puts free foot down on snow behind the other foot.

Teaching Aids Needed:

- Ski playground set up appropriately for the age and skill level of the children.
- Several set tracks close together on a gentle slope.
- Slalom poles if available (or stakes with flagging/regular ski poles).
- Ropes with fixed loops for every second child in the group.

Skill	Description	Time
Ski Play (to warm up)	Varied speeds.	5 min.
Balance (Review)	Toe Lifts: Skiers glide down a slight incline, lifting the tip of one ski by raising their toes. Repeat with each ski. Next move to the slope that has set tracks close together. Skiers go down the incline stepping sideways from track to track as they move from the left to the right side of the slope.	5 min.





<p>Snowplow Braking (Review)</p>	<ol style="list-style-type: none">1) Coach demonstrates and reviews key points.2) Have skiers form wedge with ski tips together and tails apart.3) Have skiers control speed by adjusting the size of the wedge and edging their skis. The pressure on each ski should be equal, so that the skier does not turn to the left or right.4) Skiers maintain upper body in Ready Position while practising the skill.	<p>10 min.</p>
<p>Game Time</p>	<p>Fast-Slow Poles: This exercise will help skiers learn the snowplow technique. In Practice Plan 9, cones were used to mark the snowplow sections. This time you will use “gates” marked with ski poles. Note: This exercise should only be used if the skier has the skill level to use the Snowplow technique. The diagram below shows the set up of the markers. Narrow gates: one metre apart. Wide gates: two metres apart. Skiers tuck through the narrow gate, snowplow through the wide gate, and tuck again to pass through the narrow gate. The ski tails should brush the poles as the skiers go through the wide gate.</p> <p>Figure 5.2 - Fast Slow Poles</p> 	<p>10 min.</p>





<p style="text-align: center;">Diagonal Stride (without poles) (Introduce)</p>	<p>Coach demonstrates and reviews key points.</p> <p>Scooter Exercise: Practise Diagonal Stride elements using this activity:</p> <ol style="list-style-type: none"> 1) Skiers remove their right ski and stand on their left ski in the right hand track. 2) Skiers then push their way down the track using their right hand foot. They push themselves slowly up on the left ski to glide for a period between push-offs. This is done with an emphasis on transferring the skier's weight from the foot to the ski. 3) The kick foot stays behind until the glide ski comes to a stop. 4) Skiers bring the free foot beside or ahead of the glide foot when starting the next push. 5) Switch the ski to the other foot and repeat. 	<p style="text-align: center;">10 min.</p>
<p style="text-align: center;">Game Time</p>	<p>Horse and Carriage: The coach makes two lines in the snow about ten metres apart. Skiers are paired up, with one skier playing the role of the horse, and the other the role of the carriage. Using a rope with a fixed loop, the horse double poles forward, pulling the carriage from the first line to the second one. Horse and carriage then exchange roles.</p> <p>Scooter Cops and Robbers: Everyone has only one ski on. One coach is the "cop." The skiers are "robbers." The robbers are safe as long as they are in a marked area (hideout). However they cannot stay in the hideout for more than five seconds. One of the marked areas is a prison. When captured robbers are tagged by a free robber, they can go free. Switch skis to opposite foot after five minutes.</p>	<p style="text-align: center;">10 min.</p> <p style="text-align: center;">10 min.</p>
<p style="text-align: center;">Ski Play</p>	<p>Ski playground under supervision of the coaches. Coaches provide some one-on-one instruction.</p>	<p style="text-align: center;">20 min.</p>

Conclude the session with hot chocolate, snacks and a short social time at the day lodge.





PRACTICE PLAN 12 (LEVEL 1 – ON SNOW)

SPECIAL ACTIVITY – TREASURE HUNT

Specific Objectives:

- 1) Put into practice skills learned during regular practice sessions.
- 2) Have fun.

Key Teaching Points:

- Prepare the setting ahead of time.
- Following the Treasure Hunt, time permitting, provide supervised ski play time at the ski playground. Conclude the session with hot chocolate and snacks in the day lodge.

Teaching Aids Needed:

- Refer to section 5.5 for more information. Additional information is available in subsequent NCCP workshop materials.
- A good imagination.
- Various pieces of equipment and signs to set up for the hunt.
- Extra help from parents and other coaches.

Conclude the session with hot chocolate and snacks at the day lodge. Extend the supervised activity time in the day lodge as appropriate.





PRACTICE PLAN 13 (LEVEL 1 – ON SNOW)

Specific Objectives:

- 1) Develop and improve skier balance and agility.
- 2) Review Diagonal Stride without poles.

Teaching Aids Needed:

- Ski playground set up appropriately for the age and skill level of the children.

Skill	Description	Time
Ski Play (to warm up)	Varied speeds.	5 min.
Balance (Review)	Snakes: This game is also known as “Follow the Leader”. The skiers follow a coach, who leads the group through the ski playground, changing directions frequently, going over or around obstacles and using different terrain. The coach might also include different skills such as Side Step, Herringbone and shuffling in the tracks.	15 min.
Diagonal Stride (without poles) (Review and introduce)	<ol style="list-style-type: none"> 1) Coach demonstrates as he/she leads the group. 2) Skiers cross the area sliding their skis in a “jogging-like” action, pushing off the balls of their feet, and lifting the ski off the snow at the back. Skiers should continue the glide on the front ski. 3) For additional details refer to 4.3.1. <p>Scooter Exercise: Practise Diagonal Stride</p>	





	<p>elements using this activity:</p> <ol style="list-style-type: none">1) Skiers remove their right ski and stand on their left ski in the right hand track.2) Skiers then push their way down the track using their right foot. They push themselves slowly up on the left ski to glide for a period between push-offs. This is done with an emphasis on transferring the skier's weight from the foot to the ski.3) The kick foot stays behind until the glide ski comes to a stop.4) Skiers bring the free foot beside or ahead of the glide foot when starting the next push.5) Switch the ski to the other foot and repeat.	15 min.
Game Time	<p>Horse and Carriage: The coach makes two lines in the snow about ten metres apart. Skiers are paired up, with one skier playing the role of the horse and the other the role of the carriage. Using a rope with a fixed loop, the horse double poles forward, pulling the carriage from the first line to the second one. Horse and carriage then exchange roles.</p>	10 min.
	<p>Freeze Scooter Tag: One coach acts as the "chaser." Skiers remove one ski. They freeze on one leg when tagged by the chaser. Frozen skiers may be unfrozen if tagged by a free skier. Alternate skis after five minutes.</p>	15 min.
Ski Play	<p>Ski playground under supervision of the coaches. Coaches provide some one-on-one instruction.</p>	20 min.

Conclude the session with hot chocolate, snacks and a short social time at the day lodge.





PRACTICE PLAN 14 (LEVEL 1 – ON SNOW)

SKILL EVALUATION SESSION

Specific Objectives:

- 1) On a ski trail, be able to use all skills learned.
- 2) Review and evaluate skiers for year end skill awards.

Key Teaching Points:

- Prepare a trail for the “Adventure” ahead of time. It may be best to close that trail off from the public, depending on the features you set up for the session.

Teaching Aids Needed:

- A good imagination.
- Various pieces of equipment and signs to prepare the trail.
- Extra help from parents or other coaches.
- “Skill Criteria and Evaluation Benchmarks - Level 1” and “Skill Checklist - Level 1” from your Reference Material (sections 4.3.1 and 4.3.2).
- Clipboard with plastic protection.

Skill	Description	Time
Ski Play (to warm up)	Varied speeds.	5 min.
Review All Level 1 Skills	<p>The Adventure: The coach takes the group on a ski on an easy terrain trail that is approximately one or two kms in length. Describe it as the “<i>Trip Around the World.</i>” When crossing wild rivers, skiers need to “walk like a duck” (i.e. herringbone). When they come to the “sleeping crocodiles” (i.e. coloured ropes or painted lines) they side step over them, etc.</p> <p>During the session, coaches evaluate the skiers’ skills and record their evaluation on the Skills Checklist.</p>	45 min.





Ski Play	Ski playground under supervision of the coaches. Some one-on-one instruction.	30 min.
-----------------	--	---------

Conclude the session with hot chocolate, snacks and a short social time at the day lodge.





PRACTICE PLAN 15 (LEVEL 1 – ON-SNOW)

Specific Objectives:

- 1) Work with individual skiers to improve skills that are below Level 1 standard.
- 2) Continue to evaluate skiers for year end skill awards.

Teaching Aids Needed:

- Appropriate video to show the group what they can achieve if they continue to improve their ski skills, and to inspire them to work towards this goal.
- Ski playground area set up appropriately for the age and skill level of the skiers.

Skill	Description	Time
Review Technique Skills	Video presentation in day lodge.	30 min.
	Skiers prepare for on-snow session.	15 min
Work on Skills Ski Play	<ol style="list-style-type: none"> 1) Skiers use ski playground under the supervision of the coaches. 2) Coach demonstrates and goes over key points (with individual skiers) of skills that have been identified as requiring improvement. One-on-one basis. 	35 min.

Conclude the session with hot chocolate, snacks and a short social time at the day lodge.





PRACTICE PLAN 16 (LEVEL 1 – ON SNOW)

YEAR END ACTIVITY

Specific Objectives:

- 1) Have fun.
- 2) Encourage team work and the integration of ski skills through adventurous, cooperative activities.
- 3) Wind up the season ski activities.
- 4) Recognize enthusiasm, effort, skill achievement and respect for others.

Teaching Aids Needed:

- Awards, Progress Reports.
- This depends entirely on the activities that are used.
- Refer to sections 4.3 and 5.5.

Conclude the session with hot chocolate and snacks at the day lodge. Extend the supervised activity time in the day lodge as appropriate.





5.4 Practice Plans: FUNdamentals Stage of Development - Level 2

Points to keep in mind in addition to those listed in sections 5.2 and 5.3.

- ❑ If you don't already have them, you should acquire the report cards from the previous year for each skier enrolled in your program.
- ❑ All the practice sessions focus on classic technique with the exception of Practice 12, which focuses on skating technique.
- ❑ Poles will be required when learning some skills, not others. Moreover the use of poles will depend to some extent on the skill level of the individual skier. Some children will be ready to advance to using poles more quickly than others.
- ❑ Begin to introduce very brief demonstrations with respect to nutrition, rehydration, the reasons why skiers should warm up before practices, etc., during the Wrap Up period.



**PRACTICE PLAN 1 (LEVEL 2 – ON SNOW)****Specific Objectives:**

- 1) Have FUN!
- 2) Assess general ski abilities to ensure skiers are in the appropriate group.
- 3) Assess ski equipment to determine if appropriate for Level 2 skill development.
Provide feedback to parents if equipment is inadequate.
- 4) Review and introduce Diagonal Stride on flats without poles.

Key Teaching Points: **Diagonal Stride (Scooter Exercise)**

- ✓ Weight is on the free foot. Pushing down and back, transfer weight onto gliding ski.
- ✓ Do it slowly.
- ✓ Put free foot down beside or ahead of gliding foot.
- ✓ Common errors:
 - skier cannot balance on ski (weight isn't transferred)
 - skier puts free foot down on snow behind glide foot.

Teaching Aids Needed:

- Trails groomed for classic technique.
- Sufficient parallel sets of tracks to play the Scooter game.
- Ski playground set up appropriately for the age and skill level of the skiers.
- Name tags (masking tape and marker) to identify the skiers.
- Cones.
- Help from parents and other coaches.

Skill	Description	Time
Ski Play (to warm up)	Varied speeds.	5 min.





<p>Balance and Agility</p>	<ol style="list-style-type: none"> 1) Coach provides a demonstration of the Ready Position. 2) Skiers stand on left leg only. 3) Skiers stand on right leg only. 4) Skiers stand on left leg only and touch left ski with hand. 5) Skiers stand on right leg only and touch right ski with hand. 6) Skiers lie on their back and rise up to Ready Position as quickly as they can. 	<p>5 min.</p>
<p>Review and Assess Level 1 Skills</p>	<p>Follow the Leader: The skiers follow one of the coaches who leads them through a number of exercises as they move through the ski playground:</p> <ol style="list-style-type: none"> 1) Have skiers Fall and Rise. 2) Have skiers Diagonal Stride – running step. 3) Have skiers do a figure eight. 4) Have skiers Herringbone up a small hill. 5) Have skiers practice Snowplow Braking down the hill. 6) Have skiers Side Step up a slope. 7) Have skiers Free Glide down the slope. 	<p>20 min.</p>
<p>Game Time</p>	<p>Star Turn Tails (Simon Says): The coach demonstrates a Star Turn, keeping the tails of the skis together. To begin the game, the coach says “Simon says turn to the right”, “Simon says go faster”, etc. The skiers act on the instructions only if the coach says “Simon says....”</p>	<p>5 min.</p>





<p>Diagonal Stride (without poles) (Review and Introduce)</p>	<ol style="list-style-type: none"> 1) Coach demonstrates as they lead the group. 2) Skiers cross the area sliding their skis in a “jogging-like” action, pushing off the balls of their feet, and lifting the ski off the snow at the back. Skiers should continue the glide on the front ski. 3) For additional details refer to 4.3.1, 4.3.3 and 4.2.1. <p>Scooter Exercise: Practise Diagonal Stride elements using this activity:</p> <ol style="list-style-type: none"> 1) Skiers remove their right ski and stand on their left ski in the right hand track. 2) Skiers then push their way down the track using their right foot. They push themselves slowly up on the left ski to glide for a period between push-offs. This is done with an emphasis on transferring the skier’s weight from the foot to the ski. 3) The kick foot stays behind until the glide ski comes to a stop. 4) Skiers bring the free foot beside or ahead of the glide foot when starting the next push. 5) Switch the ski to the other foot and repeat. 	<p>10 min.</p>
<p>Game Time</p>	<p>Freeze Scooter Tag: One coach acts as the “chaser”. Skiers remove one ski. They freeze on one leg when tagged by the chaser. Frozen skiers may be unfrozen if tagged by a free skier. Alternate skis after five minutes.</p>	<p>10 min.</p>
<p>Ski Play</p>	<p>Skiers use the ski playground under the supervision of the coaches. Coaches provide some one-on-one instruction.</p>	<p>20 min.</p>
<p>Wrap Up (in day lodge)</p>	<p>Wrap up with an information session explaining the Program Awards and other administrative or logistical program details. Coaches meet parents. Conclude the session with hot chocolate, snacks and a short social time.</p>	<p>15 min.</p>





PRACTICE PLAN 2 (LEVEL 2 – ON SNOW)

Specific Objectives:

- 1) Develop and improve the skier's balance and agility.
- 2) Review Diagonal Stride without poles.
- 3) Introduce Sidestepping uphill.
- 4) Introduce Herringbone on the uphill.

Key Teaching Points:

☐ Diagonal Stride (without poles)

- ✓ Scooter: ankle and knee both bend when pushing.
- ✓ Scooter: arms swing comfortably opposite to leg stride.
- ✓ Common errors:
 - skier pushes with a straight leg.
 - skier does not weight ski when pushing.
 - skier does not transfer weight onto glide ski (weight shift) during the leg push.
 - skier's arms swing across chest and not up and down the track.
 - arm swing is same as leg stride - i.e. left leg and left arm are moving forward at the same time.

☐ Side Stepping Uphill

- ✓ Skier steps sideways up hill and edges the outside (uphill) side of the ski.
- ✓ Skier puts weight on uphill ski, bringing the other ski parallel.
- ✓ Skier edges uphill side of ski, puts weight on it, and steps sideways again.
- ✓ Body is in Ready Position.
- ✓ Skis are perpendicular to the fall line.
- ✓ Common errors:
 - skis are placed on snow pointing slightly downhill or uphill.
 - skis are not edged prior to putting weight on them.

☐ Herringbone Uphill

- ✓ Inside of skis are edged into hill.
- ✓ Body remains upright.
- ✓ Knees and ankles are slightly bent.
- ✓ Skier maintains "V" shape with skis (tips apart).





- ✓ Arms swing comfortably.
- ✓ Common errors:
 - legs and ankles are straight.
 - upper body is bent at waist.
 - skier does not edge one or both skis (slides backwards).
 - skier cannot maintain both skis in “V” shape.

Teaching Aids Needed:

- Trails groomed for classic technique.
- Sufficient parallel sets of tracks to play the Scooter game.
- Ski playground set up appropriately for the age and skill level of the skier.
- A large ball for each skier in the group.
- Cones or water-soluble paint to mark the start line.

Skill	Description	Time
Ski Play (to warm up)	Varied speeds.	5 min.
Balance and Agility	<ol style="list-style-type: none"> 1) Skiers run in place on their skis, changing the tempo from slow to fast. 2) Have skiers walk on one spot extending their leg backwards. 3) Have skiers balance on one leg with the other extended backwards. Hold that position for three seconds and then switch. <p>Sizzling Snow: While remaining in one place the skiers step from ski to ski, keeping only one ski on the burning snow at a time. Have the skiers “hiss” as the snow “burns their skis”.</p>	5 min.
Diagonal Stride (without poles) (Review)	Coach demonstrates and reviews key points. For details refer to 4.3.1, 4.3.3 and 4.2.1.	10 min.





<p>Game Time</p>	<p>Scooter Glide: Skiers remove one ski and practise scootering and gliding on one ski for as long as possible. The contest is to see who can glide the longest. A variation of the game is to have the skiers count the number of pushes they require to cover the distance between the start line and finish line. This game encourages a more powerful push and a better glide.</p>	<p>10 min.</p>
<p>Side Stepping Uphill (Introduce)</p>	<ol style="list-style-type: none"> 1) Coach explains what a “fall line” is, and then demonstrates the skill and reviews the key points. For details refer to section 4.3.1. 2) If space allows, each skier Side Steps up the slope five steps, waits a moment, and then Side Steps down to the start point. 3) Repeat facing in the opposite direction. 	<p>5 min.</p>
<p>Game Time</p>	<p>Uphill Basketball: Skiers are given a large size ball that they hold in front of their chest, using both hands. The skiers Side Step up the hill carrying the ball, and then return back down in a Free Glide, still holding the ball. At the bottom of the hill the skier throws the ball into a basket or through a hoop, depending on how the game is set up. Option: place two 2-metre long ropes perpendicular to the Fall Line for the skiers to Side Step over during the uphill portion of the game.</p>	<p>10 min.</p>
<p>Herringbone (uphill) (Introduce)</p>	<ol style="list-style-type: none"> 1) Coach demonstrates Herringbone on the flats and reviews key points. 2) Have skiers approach the Herringbone from the diagonal walking position (skis parallel), moving forward. 3) Have skiers open up their skis into a Herringbone while moving forward. 4) Skiers then narrow their skis back into a parallel position, and continue to move forward. 	<p>10 min.</p>





Herringbone (uphill) (Introduce) continued...	<p>5) For additional details refer to 4.3.1 and 4.3.2.</p> <p>6) The coach then demonstrates Herringbone on an uphill and reviews the key points. Refer to section 4.3.3 for details.</p> <p>7) The skiers try this several times, Free Gliding back down the hill.</p>	10 min.
Game Time	<p>Red Light, Green Light: The coach is the policeman, and is positioned at the top of the hill. The skiers are positioned at the bottom of the hill, spread out behind the start line, and facing the policeman. When the policeman says “green light” the skiers Herringbone up the hill. When the policeman says “red light” the skiers stop. Once they reach the top of the hill they Free Glide back to the bottom. When caught moving on a red light (going up or down), skiers have to sidestep back to the start line at the bottom of the hill.</p>	5 min.
Ski Play	<p>Skiers use the ski playground under the supervision of the coaches. Coaches provide some one-on-one instruction.</p>	20 min.
Wrap Up (in day lodge)	<p>Conclude the session with hot chocolate, snacks and a short social time.</p>	15 min.





PRACTICE PLAN 3 (LEVEL 2 – INDOORS)

SKI PREPARATION SESSION

Specific Objectives:

- 1) Teach skiers that good ski-care habits and appropriate ski preparation will result in positive ski experiences.
- 2) Teach skiers the purpose of the tools and waxes in their personal wax kit.
- 3) Have skiers practice the basic steps of grip wax application.

Note: Advise parents to bring the skier's classic skis to this session.

Key Teaching Points:

- Ski Care.** The coach reviews the principles of good ski care from the previous year:
 - ✓ Put your name on your equipment (if applicable).
 - ✓ How to carry your ski equipment.
 - ✓ Don't ski where there is gravel or dirt.
 - ✓ Don't leave your ski poles lying around where someone can step on them.
 - ✓ Place your equipment in the appropriate place when you go into the day lodge.
 - ✓ Store your equipment properly after each session; put socks over the tips and tails; use ski fasteners to hold the skis firmly together, etc.
 - ✓ Learn to prepare your own skis. Don't wait for an adult to do it!
- Ski Preparation – Application of Grip Wax**
 - ✓ Review what was covered the previous year:
 - The first step is inspection. Hold the ski up to the light and look down the base. Look for bumps, tears, etc.
 - Have the skier place a classic ski firmly in the ski form.
 - Clean the ski top, sides and bottom with wax remover.
 - Dry thoroughly.
 - Using a plastic scraper, make a couple of passes from tip to tail in a continuous motion.
 - Take some fiberlene or paper towel and wipe the ski.
 - ✓ At this point the coach should check the ski to see if it needs work, and either repair the ski or inform the parent if it needs special attention.
 - ✓ When the ski is ready, the coach or parent applies a glide wax to the tips and tails of the ski. Once this step is complete, the skier can begin the process of applying grip wax.





- Have the skier take some sandpaper (80 grit) and rough up the grip zone of the ski. If the ski is used for both classic and skating techniques, the skier should be very cautious about executing this step.
- Make sure the grip wax is cold.
- Rub a thin layer of the grip wax into the grip zone of the ski and smooth out the layer with a cork.
- Start with 3-4 thin layers of grip wax.
- Skiers then “test” their skis.
- If the grip is not adequate the skier can add one or two more layers, or a slightly softer wax.
- If the grip is still not adequate, the next step is to lengthen the grip zone.
- Finally, if the grip is still inadequate, it should be scraped off with a plastic scraper and the process repeated with a softer wax.

Teaching Aids Needed:

- A suitable room to hold a ski preparation session.
- Set tracks close to the room so that the skiers can test their skis.
- An appropriate number of coaches/parents to provide close supervision.
- Ski forms and supplies of tools, etc.
- Refer to section 3.5 of the Introduction to Community Coaching Reference Material or
- “*Skill Criteria and Evaluation Benchmarks - Level 2*” and “*Skill Checklist - Level 2*” from your Reference Material (sections 4.3.3 and 4.3.4).

Ensure adequate supervision for all ski preparation sessions!

Conclude the session with hot chocolate, snacks and a short video.





PRACTICE PLAN 4 (LEVEL 2 – ON SNOW)

Specific Objectives:

- 1) Review and improve the skier's balance and agility.
- 2) Review and introduce Diagonal Stride without poles.
- 3) Introduce Star Turn with tails apart.
- 4) Review and introduce Falling and Rising on a slope.

Key Teaching Points:

□ Diagonal Stride (without poles)

- ✓ Weight is transferred from ski to ski so skier is balancing on one leg at a time.
- ✓ Skier bends ankle and knee when pushing.
- ✓ Arms swing naturally opposite to leg stride.
- ✓ Arms swing parallel to track.
- ✓ Common errors:
 - skier pushes with a straight leg.
 - skier does not weight ski when pushing.
 - skier does not transfer weight onto glide ski (weight shift) during the leg push.
 - skier's arm swings across chest, and not up and down the track.
 - skier's arm swing is the same as leg stride (i.e. left leg/arm moves forward at same time).

□ Star Turn (with tails apart)

- ✓ Skier's arms and hands stay forward of body.
- ✓ Skier forms slight wedge with ski tips together and tails apart
- ✓ With weight on one ski, the skier lifts the tail of other ski and widens wedge.
- ✓ Skier puts weight on other ski and brings first ski parallel.
- ✓ Repeat until full circle is made keeping ski tips on one spot.
- ✓ Common errors:
 - skier keeps centre of gravity between skis.
 - skier steps on top of other ski.

□ Falling and Rising (on a slope)

- ✓ Falls to the side, using sitting motion, while gliding down gentle slope.
- ✓ Skier positions skis on downhill side of body, and perpendicular to the fall line.





- ✓ While edging the skis, skier moves to hands and knees position over the skis.
- ✓ Skier slides one foot forward and stands up.
- ✓ Common errors:
 - skier is afraid to fall.
 - skier falls forward.
 - skier tries to stand up before positioning skis on downhill side of body and perpendicular to the fall line.
 - skier tries to stand up before skis are edged.
 - skier tries to stand up before hips are over skis.

Teaching Aids Needed:

- Trails groomed for classic technique.
- Help from parents and other coaches.
- Sufficient parallel sets of tracks to play the Scooter game.
- Cones or other markers for prison, hideouts and start line.
- Coloured sticks.
- Ski playground set up appropriately for the age and skill level of the skier.
- Blocks 10-20 cm high.

Skill	Description	Time
Ski Play (to warm up)	Varied speeds.	5 min.
Balance and Agility	<ol style="list-style-type: none"> 1) Have skiers walk on their toes. 2) Have skiers walk on their toes with ankles and knees bent. 3) Have skiers walk on one spot extending the leg backwards. 4) Have skiers walk on one spot, extending the leg backwards and holding it for three seconds. 5) Repeat. 	5 min.





<p>Diagonal Stride (without poles) (Review and Introduce)</p>	<ol style="list-style-type: none"> 1) Coach demonstrates and reviews key points. 2) Skiers ski slowly emphasizing their weight shifting from the pushing/kicking ski to the gliding ski. 3) Add an emphasis on bending ankle and knee. 4) Add an emphasis on proper arm swing. 	<p>10 min.</p>
<p>Game Time</p>	<p>Scooter Hurdles: The skiers prepare for Scooter as usual by removing a ski, but this time they must all remove their right ski. Obstacles are placed beside the tracks, on the right side, 1-2 m apart, and 10-20 cm high. Skier place their left ski in the right track, and move forward. Each time they step over an obstacle, it forces them to place their weight on the gliding ski. Repeat on a different course using the opposite ski.</p>	<p>10 min.</p>
<p>Star Turn (with tails apart) (Introduce)</p>	<ol style="list-style-type: none"> 1) Coach demonstrates and reviews key points. 2) Skiers do the exercise in both directions. 	<p>5 min.</p>
<p>Game Time</p>	<p>Cops and Robbers: One coach is the “cop”. The skiers are “robbers”. The robbers are safe as long as they are in a marked area (hideout). However, they cannot stay in the hideout for more than five seconds. One of the marked areas is a prison. When a robber is tagged by a cop, they must go to prison. When a captured robber is tagged by a free robber, they can go free.</p>	<p>10 min.</p>





Falling and Rising (on a slope) (Introduce)	<ol style="list-style-type: none">1) Coach demonstrates and explains key points.2) Have the skiers Free Gliding down a gentle slope.3) Have the skiers fall to one side.4) When they rise, have them continue with their Free Glide to the bottom of the slope, or have them herringbone back to the top.5) Repeat, but this time have the skiers fall on the other side.	5 min.
Game Time	Pick Up Sticks: Skiers start at the bottom of a hill. They ski up the hill using the technique of choice, and then Free Glide down the hill. Parallel to the tracks there are sticks lying flat on the snow. As the skiers come down the hill they try to pick up a stick.	10 min.
Ski Play	Skiers use ski playground under the supervision of the coaches. Coaches provide some one-on-one instruction.	20 min.
Wrap Up (in day lodge)	Conclude the session with hot chocolate, snacks and a short social time at the day lodge.	15 min.





PRACTICE PLAN 5 (LEVEL 2 – ON SNOW)

Specific Objectives:

- 1) Develop and improve the skier's balance and agility.
- 2) Review Diagonal Stride without poles.
- 3) Review and introduce Free Glide.
- 4) Review and introduce Snowplow Braking.

Key Teaching Points:

Free Glide

- ✓ Skier's arms and hands stay forward of body while gliding down gentle hill.
- ✓ Body remains upright.
- ✓ Knees and ankles are slightly bent.
- ✓ Common errors:
 - legs and ankles are straight.
 - upper body is bent at waist.
 - one or both hands are by body.

Snowplow Braking

- ✓ Skier stands in Ready Position with arms and hands forward of body, body upright and knees and ankles bent.
- ✓ Skis form wedge with tips closer together.
- ✓ Knees come closer together, and ankles roll in to edge skis.
- ✓ The amount of edging and the size of the wedge control the speed.
- ✓ Common errors:
 - skier's legs and ankles are straight and therefore skis are not edged.
 - upper body is bent at waist.
 - skier turns while braking (failure to put equal pressure on both inside edges).
 - arms and hands are not forward of the body.

Teaching Aids Needed:

- Trails groomed for classic technique.
- Help from parents and other coaches.
- Cones or other markers for prison, hideouts and start line.





- Ski playground set up appropriately for the age and skill level of the skier.
- “Hurdles” 20-30 cm high for Scooter exercises.
- Enough socks with tennis balls in them for each skier in the group.

Skill	Description	Time
Ski Play (to warm up)	Varied speeds.	5 min.
Balance	<p>Pendulum Swings: Skiers stand on one leg while swinging the other leg back and forth. Begin slowly, and then increase the tempo.</p> <p>Combo Swing: Skiers stand on one leg while swinging the other leg back and forth. When the skiers stand on their left leg, the left arm swings in the same direction as the right leg and the right arm swings in the opposite direction.</p>	5 min.
Diagonal Stride (without poles) (Review)	<ol style="list-style-type: none"> 1) Coach demonstrates and reviews key points. 2) Skiers Diagonal Stride slowly with emphasis on shifting weight from the pushing/kicking ski to the gliding ski 3) Add emphasis on bending ankle and knee. 4) Add emphasis on proper arm swing. 5) Coach demonstrates and reviews key points of the Scooter exercise. 6) Emphasize bending the knee and ankle just before the push. 7) Emphasize starting the push with a flat foot. 8) Emphasize a relaxed arm swing. 9) Switch to the other ski after five min. 10) Use hurdles for the skiers to clear with their pushing foot. 11) Skiers then put on both skis and practice scootering, but this time pushing off with their ski. Coach moves around group providing one on one instruction. 	5 min.





<p>Game Time</p>	<p>Scooter Cops and Robbers: Everyone has only one ski on. One coach is the “cop”. The skiers are “robbers”. The robbers are safe as long as they are in a marked area (hideout). However they cannot stay in the hideout for more than five seconds. One of the marked areas is a prison. When a robber is tagged by a cop, they must go to prison. When a captured robber is tagged by a free robber, they can go free. Switch skis to opposite foot after five minutes.</p>	<p>10 min.</p>
<p>Free Glide (Review and Introduce)</p>	<ol style="list-style-type: none"> 1) Coach demonstrates and reviews key points. 2) Skiers stand in Ready Position (body generally upright, knees and ankles relaxed and slightly bent). 3) Skiers keep hands forward and skis parallel. 4) Pole handles are down and in front of body, with pole tips pointed behind. The pole shaft is angled down and backward so that it doesn't drag on the snow. 5) Skiers Free Glide down the slope and Side Step back up the hill. 6) Repeat several times. 	<p>5 min.</p>
<p>Game Time</p>	<p>Fetch: A start line is marked on one side of the field, and a finish line on the other. Each skier has a sock with a ball in it. The skiers line up at one edge of the field and throw the sock as far down the field as they can. They Diagonal Stride as fast as they can to the sock, and execute a full Star Turn (tails apart) around the sock. The skier then picks up the sock and throws it further down the field towards the finish line. This continues until the sock lands past the finish line. Option: Have a basket at the end of the field rather than a finish line.</p>	<p>10 min.</p>





<p>Snowplow Braking (Review and Introduce)</p>	<ol style="list-style-type: none"> 1) Coach demonstrates and reviews key points. Refer to sections 4.3.1 and 5.3 - Practice Plan 10 for detailed information. 2) Skiers start on the flat in a Ready Position, forming a wedge with their skis. 3) Have skiers edge and flatten their skis while in a stationary position. 4) Move to the top of a slope that has the appropriate gradient and length for this skill level of skier. 5) Arrange ahead of time for a cone marker to be placed in the run out area beyond the bottom of the hill. 6) Have skiers descend the hill as slowly as possible, coming to a Snowplow Stop at the bottom, as close to the cone as possible. 7) Slowly move the cone closer to the bottom of the hill, forcing the skiers to control their speed more and brake harder. 	<p>10 min.</p>
<p>Game Time</p>	<p>Snowplow Snake: The coach begins in a Snowplow position at the top of a slope. The first skier moves into a Snowplow position behind the coach, holding onto the coach's waist. The next skier moves into position behind the first skier, and so on. The coach does a slow Snowplow down the hill. Note: The skiers may require some help to get into formation. Option: Add one or two bumps on the downhill slope for the "snake" to go over.</p>	<p>10 min.</p>
<p>Ski Play</p>	<p>Skiers use the ski playground under the supervision of the coaches. Coaches provide some one-on-one instruction.</p>	<p>20 min.</p>
<p>Wrap Up (in day lodge)</p>	<p>Conclude the session with hot chocolate, snacks and a short social time.</p>	<p>15 min.</p>





PRACTICE PLAN 6 (LEVEL 2 – ON SNOW)

Specific Objectives:

- 1) Develop and improve the skier's balance and agility.
- 2) Review Free Glide.
- 3) Introduce Kick Turn on flats.
- 4) Review and introduce Diagonal Stride without poles.

Key Teaching Points:

Kick Turn (on flats)

- ✓ Skier balances on one ski, and lifts the other ski tip high enough to get the tail off the snow, and turn the ski around so the tip is pointing almost backwards.
- ✓ Skier balances on turned ski, lifts first ski tips up high enough to get tail off snow and places it parallel to other ski.
- ✓ Common errors:
 - skier isn't balanced on first ski when they move the second ski.
 - skier doesn't lift second ski high enough for tail to clear the snow.
 - skier places one ski on top of the other.

Diagonal Stride (without poles)

- ✓ Weight is transferred from ski to ski so skier can balance on one leg.
- ✓ Ankle and knee are bent when pushing.
- ✓ Arms swing naturally opposite leg stride.
- ✓ Arms swing parallel to track.

Teaching Aids Needed:

- Trails groomed for classic technique.
- Cones or other markers for prison, hideouts and start line.
- Help from parents and other coaches.
- Ski playground set up appropriately for the age and skill level of the skier.





Skill	Description	Time
Ski Play (to warm up)	Varied speeds.	5 min.
Balance and Agility (Introduce)	<ol style="list-style-type: none"> 1) Have skiers lie on their backs and get up as fast as they can. Repeat several times. 2) Skiers stand in place with their skis in a “V” position. They edge the inside of one ski, and then the other. <p>The Walking Duck: Skiers walk in one place with skis in a “V” position, pausing over each ski for two seconds. Next have skiers run in one place with their skis in a “V” position.</p>	5 min.
Kick Turn (on flats) (Introduce)	Coach demonstrates and reviews key points. For details refer to section 4.3.3.	10 min.
Game Time	<p>Crows and Owls: The objective of this game is to work on turning from a stationary position and forward movement without poles. Form two equal teams. One team will be “Crows” and the other team “Owls”. The two teams form lines with one team facing the other. The lines need to be marked by ski poles or a similar marker at each end. The two lines should be 20 to 30 metres apart. For each team, its own line is its “home”. The coach then makes a statement that is easily identified as either true or false. If it is true, the Owls (who are wise and honest) chase the Crows; if it is false the Crows (who are sly, devious and don’t always know the truth) chase the Owls. The team being chased must turn around and ski past the poles identifying its home line to be safe. A skier who is tagged by a skier from the other team before they get safely home must join that team.</p>	10 min.
Free Glide (Review)	Coach demonstrates and reviews key points. For details refer to Practice Plan 5.	5 min.





<p>Balance and Agility</p>	<p>Ski Soccer: Skiers stand in a “V” position with a ball in front of them. Have the skiers move the ball across a flat area by placing the ski boot sideways to make contact. Next have the skiers balance on one ski, while lifting the other backwards. Skiers hold the ski backwards for two seconds and then slowly swing their ski forward, holding the tip off the snow for two more seconds. Repeat several times and switch legs.</p>	<p>10 min.</p>
<p>Diagonal Stride (without poles) (Review and Introduce)</p>	<ol style="list-style-type: none"> 1) Coach demonstrates and reviews key points. 2) Have the skiers practise this slowly with an emphasis on a weight transfer from the pushing/ kicking ski to the gliding ski and balance on the gliding ski when gliding. 3) Arms swing back and forth (not sideways). 4) Scooter Exercise: Skiers remove one ski and glide on the other one, pushing off with the free foot. Emphasize bending ankle and knee when pushing off. Emphasize proper arm swing. Emphasize placing the kicking foot on the snow slightly ahead of the gliding foot. Switch ski to opposite foot. 	<p>5 min.</p>
<p>Game Time</p>	<p>Scooter Relay: The group is divided into two teams. One half of each team goes behind a line at the top of a gentle slope, and the other half behind the start/finish line at the bottom. The lead skier from each team scooters up the hill (emphasis on bent ankle and knee) and tags the respective uphill teammate who then scooters down the hill (emphasis on balance and glide) to tag the third skier. Repeat using the other leg.</p>	<p>10 min.</p>
<p>Ski Play</p>	<p>Skiers use the ski playground under the supervision of the coaches. Coaches provide some one-on-one instruction.</p>	<p>20 min.</p>
<p>Wrap Up (in day lodge)</p>	<p>Conclude the session with hot chocolate, snacks and a short social time.</p>	<p>15 min.</p>





PRACTICE PLAN 7 (LEVEL 2 – ON SNOW)

A CLUB ACTIVITY

Participation in a special club activity/event exposes young skiers to the wide range of programs that clubs offer. If you live in a community that doesn't offer programs of this kind, refer to section 5.5 of the Introduction to Community Coaching Reference Material for some ideas and create a "special activity" of your own. This could be a Moonlight Ski, a Lantern Ski, a Mini-Olympics, an orienteering game, a trek to a cabin/lake for lunch and some games, or a similar activity.

Specific Objectives:

- 1) Introduce skiers to a new type of cross-country ski experience.
- 2) Practice skills learned during regular practice sessions.
- 3) Introducing skiers to their club.
- 4) Have FUN!

Key Teaching Points:

- Plan for the activity and, if necessary, prepare the setting ahead of time.
- Provide suitable coaching support for the activity that has been selected.
- No formal ski instruction.
- Use opportunities for one-on-one technique instruction.

Teaching Aids Needed:

- Extra help from parents and other coaches.
- Depends on the activity.





PRACTICE PLAN 8 (LEVEL 2 – ON SNOW)

Specific Objectives:

- 1) Develop and improve the skier's balance and agility.
- 2) Teach the correct way to hold a ski pole.
- 3) Introduce Diagonal Stride with poles.
- 4) Introduce Double Poling.
- 5) Review Snowplow Braking.

Key Teaching Points:

Diagonal Stride (with poles)

- ✓ Skier has alternating arm and leg action.
- ✓ Pole plant is opposite, and to side, of the gliding foot.
- ✓ Common errors:
 - the arm and leg on the same side of skier move forward at the same time.
 - the pole plant is ahead of the gliding foot.

Double Poling

- ✓ Skier's arms reach forward and plant poles at same time.
- ✓ Skier's legs remain relatively straight throughout the poling action.
- ✓ Skiers should be able to push themselves forward down the trail (if not, try it on a gentle downhill).
- ✓ Common errors:
 - skier shifts into a sitting position with bent knees.
 - skier either falls forward on pole plant, or falls back at the end of pole push.

Teaching Aids Needed:

- Trails groomed for classic technique.
- Cones or other markers.
- Help from parents and other coaches.
- Ski playground set up appropriately for the age and skill level of the skier.





Skill	Description	Time
Ski Play (to warm up)	Varied speeds.	5 min.
Balance and Agility	<p>Bobbing Stork: The skiers stand on one ski, bend forward at the waist, and then stand upright again, with shoulders, hips and ankles lined up one on top of the other. Skiers appear to be bobbing like a bird on one leg. Alternate legs.</p> <p>Flying Stork: The skiers leap into the air by pushing off with both legs. They land on one leg. Alternate legs.</p>	5 min.
Diagonal Stride With Poles (Introduce)	<ol style="list-style-type: none"> 1) Coach demonstrates the correct way to hold a ski pole. Refer to section 4.2.1 in the Introduction to Community Coaching Reference Materials for detailed information. 2) Diagonal Stride without poles, while holding the poles at the balance point. 3) Have skiers do the same. 4) The coach demonstrates diagonal stride with poles, and reviews the key points 5) Emphasize the pole plant opposite the front foot. 	10 min.
Game Time	<p>Penny, Penny, Who's Got the Penny? Divide the skiers into two groups. One skier on one of the teams is given a penny. The other team does not know which opposing member has the penny. The penny carrier has to try and get the penny to his/her team's castle, which is in the opponent's zone. The person who has the penny must show it if tagged. The rest of the team acts as decoys. No poles.</p>	10 min.
Double Poling (Introduce)	<ol style="list-style-type: none"> 1) Coach demonstrates and reviews key points. Refer to section 4.3.3 for detailed information. 2) Skiers do the exercise with an emphasis on relatively straight legs. 	10 min.





<p>Game Time</p>	<p>Zim, Zam, Zoom: Have the skiers form a circle, facing in. The coach is in the middle. Going around the circle, everyone says their name clearly, one at a time, so that everyone can hear it. The coach then points at a skier and says “Zim”, “Zam” or “Zoom”. If the coach says “Zim”, the skier they pointed to has to say the name of the skier on their right; if “Zam”, they have to say the name of the skier on their left; if “Zoom”, they have to say their own name. If the skier makes a mistake or hesitates too long, they have to switch places with the coach.</p>	<p>10 min.</p>
<p>Snowplow Braking (Review)</p>	<ol style="list-style-type: none"> 1) Coach demonstrates and reviews key points. 2) Have skiers practice it with an emphasis on controlled speed, a consistent Ready Position; arms and legs forward of body; upright body; and knees and ankles bent. 	<p>10 min.</p>
<p>Explore Ski Trail</p>	<p>Skiers explore a designated trail under the supervision of the coaches. The coaches provide some one on one instruction. Use poles.</p>	<p>20 min.</p>
<p>Wrap Up (in day lodge)</p>	<p>Conclude the session with hot chocolate, snacks and a short social time at the day lodge.</p>	<p>15 min.</p>





PRACTICE PLAN 9 (LEVEL 2 – ON SNOW)

Specific Objectives:

- 1) Develop and improve the skier's balance and agility.
- 2) Review and introduce Diagonal Stride with poles.
- 3) Introduce the Snowplow Stop.
- 4) Review and introduce Double Poling.

Key Teaching Points:

❑ Diagonal Stride (with poles)

- ✓ Emphasize planting the pole with a slant (pole handle ahead of pole tip).
- ✓ Emphasize forward body lean.
- ✓ Common errors:
 - Pole plant is upright or slanted with pole tip ahead of pole handle.
 - Body position is upright.

❑ Diagonal Stride (Scooter)

- ✓ Emphasize planting the kicking foot flat on the snow.
- ✓ Emphasize planting the kicking foot ahead of the gliding foot and start the kick immediately.
- ✓ Common errors:
 - heel of the kicking foot is planted first (encouraging a hips back position).
 - kicking foot is planted behind gliding foot.
 - kicking foot is planted ahead of the gliding foot, but weight has not shifted onto kicking foot until the gliding foot has passed the kicking foot (a late kick).

❑ Snowplow Stop

- ✓ Skier moves down the slope in Ready Position with arms and hands forward of body, upright body and knees and ankles bent.
- ✓ Skis form wedge with tips close together.
- ✓ Skier applies equal pressure on inside edges of skis (rolling inward with the ankles), safely reduces speed and comes to a full stop at the bottom of the hill.
- ✓ Knees come closer together and ankles roll in to edge of skis.
- ✓ Common error:
 - skier rolls ankles too abruptly, starts to lose balance and falls forward.

❑ Double Poling





- ✓ Skier's arms extend fully.
- ✓ Skier's arms are slightly bent at pole plant.
- ✓ Common errors:
 - skier's arm action stops at hips.
 - skier's arms either lock or are bent at right angles at pole plant.

Teaching Aids Needed:

- Trails groomed for classic technique.
- Sufficient parallel sets of tracks to play the Scooter game.
- Cones or other markers.
- Help from parents and other coaches.
- Ski playground set up appropriately for the age and skill level of the skier.
- Poles for the Snowplow gates.
- Brightly coloured handkerchief or surveyors tape.

Skill	Description	Time
Ski Play (to warm up)	Varied speeds.	5 min.
Balance and Agility	<p>Quick Thinking: This game tests the skiers' ability to move quickly and maintain balance. The coach stands in front of the group and points in different directions (forward, backward, side-ways). The group responds accordingly. In addition to pointing directions, the coach can call out directions as well. If two skiers collide, they are eliminated from the game. Another variation is to arrange the skiers in a large circle. The coach then calls out "hop left", "slide right", "jump left", etc. No poles.</p>	5 min.





<p>Diagonal Stride with Poles (Review and Introduce)</p>	<ol style="list-style-type: none">1) Coach demonstrates and reviews key points.2) Skier Diagonal Strides slowly with an emphasis on shifting the weight from the pushing/kicking ski to the gliding ski.3) Coach demonstrates the forward lean of the hips and upper body at the start of the leg push.4) Skier balances on right leg with a forward lean, the left leg extended backwards.5) Skiers practise Diagonal Stride with an emphasis on proper forward lean.6) Skier plants left pole with slant opposite right foot. The skier then lifts the pole and repeats the action several times.7) Repeat with the other leg.8) Skier then executes Diagonal Stride with emphasis on proper pole plant.	15 min.
<p>Game Time</p>	<p>Scooter Side Car: The coach pairs up the skiers according to their height. Skiers remove the ski opposite to the one their partner removes, and position themselves behind the start line. The partners stand side by side with their arms around shoulder and waist, and their free foot on the inside. When starting, the partners propel themselves forward by kicking at the same. Emphasize how far the skiers can glide in a single kick. Alternate skis and repeat. No poles.</p>	10 min.
<p>Snowplow Stop (Introduce)</p>	<ol style="list-style-type: none">1) Skiers move to an area that has a suitable downhill slope for practising the Snowplow Stop.2) The coach demonstrates a Snowplow Stop and reviews the key points. Refer to Practice Plan 5 for additional information.	5 min.





<p>Game Time</p>	<p>Fast-Slow Poles: This exercise will help skiers learn the Snowplow technique. Use “gates” marked with ski poles to mark the Snowplow sections of the course. Note: This exercise should only be used if the skier has the skill level to use the Snowplow technique. The diagram below shows the set up of the markers. Narrow gates: one metre apart. Wide gates: two metres apart. Skiers tuck through the narrow gate, Snowplow through the wide gate and tuck again to pass through the narrow gate. The ski tails should brush the poles as the skiers go through the wide gate.</p> <p>Diagram 5.3 – Fast-Slow Poles</p> 	<p>10 min.</p>
<p>Balance and Agility</p>	<p>Catch the Dragon’s Tail. The skiers in the group line up one behind the other. Eight to ten skiers is ideal. The skiers put their arms around the waist of the skier in front of them. The last skier in the line tucks a brightly coloured handkerchief into his/her back pocket or the back of the toque. To work up steam, the dragon should then make a few scary cries. At a signal from the coach, the dragon begins chasing its own tail, the objective being for the skier at the head of the line to snatch the handkerchief. When the skier at the head of the line finally captures the tail, he/she wears the handkerchief and becomes the new tail. The skier who was second from the front of the line then becomes the new leader. A variation is to have two dragons (chains of skiers) trying to catch the tail of the other.</p>	<p>10 min.</p>





Ski Play	Skiers use the ski playground under the supervision of the coaches. Coaches provide some one-on-one instruction.	20 min.
Wrap Up (in day lodge)	Conclude the session with hot chocolate, snacks and a short social time at the day lodge.	15 min.





PRACTICE PLAN 10 (LEVEL 2 – ON SNOW)

Specific Objectives:

- 1) Develop and improve the skier's balance and agility.
- 2) Review and introduce Double Poling.
- 3) Introduce Half-Snowplow Braking.
- 4) Introduce Herringbone with poles.
- 5) Prepare the skiers to set goals and go through a competition day routine.

Key Teaching Points:

❑ Double Poling

- ✓ Add full extension of arms.
- ✓ Add arms should be slightly bent at pole plant.
- ✓ Common errors:
 - arm action stops at hips.
 - arms are either locked at pole plant or are bent at right angles.

❑ Half-Snowplow Braking

- ✓ Skier Free Glides down slope.
- ✓ Skier puts weight on one ski while gliding, lifts the braking/plow ski out of the track, and places it in a wedge position with the tips close to tracks.
- ✓ Skier applies pressure to inside edge of the plow ski by shifting weight onto it.
- ✓ Skier presses on plow ski to reduce speed, lifts plow ski back into track, and resumes free gliding.
- ✓ Skier brakes using either ski.
- ✓ Skier maintains Ready Position throughout.
- ✓ Common errors:
 - skier doesn't transfer weight onto gliding ski and therefore can't lift other ski out of track.
 - skier is unable to put plow ski back into the track.
 - skier is unable to maintain Ready Position.
 - the pressure on the braking/plow ski causes skis to cross.

❑ Herringbone (with poles)

- ✓ Diagonal arm action.
- ✓ Plant pole tips behind and to the side of feet.





- ✓ Common errors:
 - arm action becomes independent of leg action (left pole is not planted when right ski is planted).
 - there is excessive lifting of poles off snow to “clear the skis”.
 - poles are planted too far to the side, instead of close to the skis.

Teaching Aids Needed:

- Trails groomed for classic technique.
- Coloured sticks.
- Ski playground set up appropriately for the age and skill level of the skier.

Skill	Description	Time
Ski Play (to warm up)	Varied speeds.	5 min.
Balance and Agility	<p>Flea Leaps: Have skiers jump off snow with both feet. Keep knees bent when landing.</p> <p>One-Leg Pops: Have skiers jump off snow from one ski to the other.</p> <p>Repeat each exercise several times.</p>	5 min.
Double Poling (Review)	<ol style="list-style-type: none"> 1) Coach demonstrates and reviews key points. 2) Have skiers extend their arms backwards as if poling without the pole tips hitting the snow (ensure no one is standing behind them). 3) Skiers try Double Poling in set tracks with an emphasis on the full extension of their arms (ensure no one is skiing behind them). 4) Next the skiers try this with an added emphasis on slightly bent arms on pole plant. 	10 min.
Game Time	<p>Freeze Tag: One coach acts as the “chaser”. Double Poling is the only technique allowed. The skiers freeze on one leg when tagged. Frozen skiers may be unfrozen if tagged by a free skier.</p>	10 min.





<p>Half-Snowplow Braking (Introduce)</p>	<p>The Coach demonstrates and reviews the key points. Refer to section 4.3.3 for detailed information.</p>	<p>10 min.</p>
<p>Game Time</p>	<p>Pick Up Sticks: Skiers start at bottom of a hill. They ski up the hill using the Herringbone technique and then Free Glide back down. Parallel to the tracks going down the hill there are sticks lying flat on the snow. As the skier comes down hill they try to pick up the sticks. Add one or two bumps on the downhill for the skiers to go over or jump off of.</p>	<p>10 min.</p>
<p>Herringbone With Poles (Introduce)</p>	<ol style="list-style-type: none"> 1) The coach demonstrates and reviews key points. 2) Emphasize diagonal arm action and planting poles behind and to the side of the feet. 	<p>10 min.</p>
<p>Explore Ski Trail</p>	<p>Skiers explore a designated trail under the supervision of the coaches. The coaches provide some one-on-one instruction.</p>	<p>20 min.</p>
<p>Wrap Up (in day lodge)</p>	<p>Wrap up with an information session explaining the Sprint Games that will be held at the next session. Instructions should be either handed out or emailed to the parents. Include information on clothing, food, ski equipment, the “rules” of the game, etc. Refer to section 8.3 and 8.4 for details. Conclude the session with hot chocolate, snacks and a short social time at the day lodge.</p>	<p>15 min.</p>





PRACTICE PLAN 11 (LEVEL 2 – ON SNOW)

SPECIAL ACTIVITY – SPRINT GAMES

Specific Objectives:

- 1) Introduce skiers to a speed “game”.
- 2) Have FUN!
- 3) Determine annual Program Awards for Sprints.

Notes: Classic technique is recommended for the skiers’ initial sprint experience. Be creative and add some extra fun to your Sprint Games by having a simplified costume party (i.e. most creative head gear) included in the day’s activities, or supplying temporary tattoos to all the participants.

Key Teaching Points:

- Encourage and praise each child equally for taking part in and completing the task.
- Downplay comparisons with other skiers.
- Emphasize self-improvement. There are five Program Awards for Sprints available to Jackrabbits. This first attempt can be used as the baseline against which future achievements can be measured.
- Use the opportunity for one-on-one technique instruction.

Teaching Aids Needed:

- Refer to section 8, and specifically section 8.3.3, of this manual for instructions on how to organize Sprint Games.
- Clipboard, pencil and paper with plastic protection.
- Water soluble paint and marker flags or pylons.
- Stop watches.
- Help from parents and other coaches.
- An award or prize for each skier who completes the task. This could be a Program Award (sticker) or some other prize.
- Numbered “bibs” or numbered, coloured sheets paper, with safety pins.



**Tasks:**

In addition to the instructions provided in section 8:

- Arrange ahead of time for a section of flat terrain, 100 (+) metres in length, to be packed and set with four parallel sets of tracks. The tracks should be set in a straight line, with no corners.
- Establish start and finish lines before the practice session begins.
- Explain the “rules” of the game (i.e. skiers can use classic technique only; they cannot change lanes).
- Explain the routine to the skiers and assist them through the progressive steps:
 - ✓ pick up their bib.
 - ✓ have the coach check/wax their skis.
 - ✓ tests their skis to make sure the wax works for them.
 - ✓ report back to the coach how their skis are working; test their skis again if necessary.
 - ✓ warm up.
 - ✓ stand in a start line with their team mates.
 - ✓ ski the assigned course using the designated technique.
 - ✓ stay active until their next turn.
 - ✓ repeat standing at the start line and skiing the assigned course, and
 - ✓ return their bib.
- Schedule approximately 20 minutes of supervised ski play following the sprint games.
- Wrap up with a brief information session to explain that skating technique will be introduced at the next session, and skis should be prepared accordingly.
- Conclude the session with awards, hot chocolate, snacks and a short social time at the day lodge.





PRACTICE PLAN 12 (LEVEL 2 – ON SNOW)

Specific Objectives:

- 1) Develop and improve the skier's balance and agility.
- 2) Introduce Free Skate.
- 3) Review Half-Snowplow Braking.
- 4) Introduce Snowplow Turn.

The skier will require ski equipment for skating technique. As a minimum, the skier requires skating length poles and, (if classic skis are used), the skis glide waxed the entire length of the ski.

Key Teaching Points:

❑ Free Skate

- ✓ Skier forms wedge with tips apart and tails together.
- ✓ Skier has weight on one ski, and pushes off by edging inside edge of ski.
- ✓ Skier then shifts weight to other ski and glides.
- ✓ Skier pushes off gliding ski by edging inside ski.
- ✓ Common errors:
 - keeps centre of gravity between skis.
 - does not glide equally on right and left skis.

❑ Snowplow Turns

- ✓ Skier demonstrates a Ready Position with hands forward, body upright and knees and ankles bent.
- ✓ Skier demonstrates some wedge with skis throughout the turn.
- ✓ Skier applies additional pressure to inside edge of ski opposite to the direction they wish to turn.
- ✓ After the turn the skier releases the extra pressure on the one ski and continues to descend the hill in a controlled manner.
- ✓ Common errors:
 - skier is unable to maintain Ready Position.
 - skier is unable to turn in both directions.
 - skier applies too much pressure and comes to a stop.





Teaching Aids Needed:

- Trails groomed for skating technique.
- Markers to define the Wolf Ring.
- Cones or pylons for marking the route for Downhill Targets.
- Ski playground set up appropriately for the age and skill level of the skier.
- A bucket and bean bags or tennis balls.

Skill	Description	Time
Ski Play (to warm up)	Various speeds.	5 min.
Balance and Agility	<p>Tip and Tail Touch: While skiing down a gentle slope, skiers alternate between touching the tips and tails of their skis with their hands.</p> <p>Luge: While skiing down a gentle slope, skiers first lie back on their skis. Next they practice squatting on their skis until they almost touch the snow with the seat of their pants.</p>	5 min.
Free Skate (introduce)	<ol style="list-style-type: none"> 1) Coach demonstrates and reviews key points. 2) Skiers start with their skis parallel. 3) Skiers balance on one leg, edge inside edge and push sideways and place new ski on angle. 4) Skiers bring pushing leg parallel, and glide to a stop. 5) Repeat until a circle has been completed. 6) Repeat in opposite direction. 7) Finally, skiers take a skating step in one direction and glide, and then in the other direction and glide, before stopping. 	15 min.





Game Time	Downhill Targets: Choose a slope with a gradient that is suitable for the skill level of the skiers in the group. Set up a downhill course with a start and finish line, and pylons and large curves in between. Skiers begin at the top of the slope and Free Skate around the curves and across the finish line. After crossing the finish line they need to pick up a bean bag and throw it in a bucket before they have completed the game. A variation of this game is to have the skiers turn completely around each pylon before heading on to the next one.	10 min.
Half-Snowplow Braking (Review)	Coach demonstrates and reviews key points. For details refer to section 4.3.3.	5 min.
Snowplow Turns (Introduce)	<ol style="list-style-type: none">1) Skiers stand in a Snowplow position on the flat.2) Skiers edge their skis.3) Have skiers carefully move their skis so they can look at the marks they left in the snow.4) Repeat, but have the skiers edge their right ski harder to make a bigger mark in the snow. Repeat with the left ski.5) The coach demonstrates a Snowplow Turn on a hill and reviews the key points.6) Skiers each try one turn (either right or left). At first they may prefer to make the turn on the flat during the run out. As their confidence increases, have them do the turn on the hill.	10 min.





<p>Game Time</p>	<p>Wolf Ring: A defined area with both perimeter and diameter lines is established for the game. Skiing is permitted around the perimeter and across each of the diameters, but in one direction only. A hunter, “the wolf”, chases the rabbits within the defined area. When the wolf tags a rabbit, that person becomes a wolf as well. The game continues until the last rabbit is tagged. The size of the area can vary according to the age of the participant. The coach may or may not decide to choose to use poles depending on space available to play the game. Refer to 4.3.9 for an illustration.</p>	<p>10 min.</p>
<p>Ski Play</p>	<p>Ski playground under supervision of the coaches. Some one-on-one instruction may be provided in areas where skiers need improvement to meet the skill criteria.</p>	<p>20 min.</p>
<p>Wrap Up (in day lodge)</p>	<p>Wrap up by reminding the group that the next practice session will be classic technique. Conclude the session with hot chocolate, snacks and a short social time at the day lodge.</p>	<p>15 min.</p>



**PRACTICE PLAN 13 (LEVEL 2 – ON SNOW)****Specific Objectives:**

- 1) Develop and improve the skier's balance and agility.
- 2) Review Diagonal Stride with poles.
- 3) Review and introduce Double Poling.
- 4) Review Snowplow Turn.
- 5) Develop the skier's awareness of the importance of rehydration during physical activity.

Key Teaching Points: **Double Poling**

- ✓ Skier adds upper body flexion to poling action.
- ✓ Upper body remains bent until arms are extended.
- ✓ Proper timing of contractions is upper body, abdomen, shoulders and elbows.
- ✓ Common errors:
 - skier uses arms only.
 - upper body straightens before arm extension is complete.

Teaching Aids Needed:

- Trails groomed for classic technique.
- Coloured clothes pins.
- Example of water bottle and water bottle holder.
- Ski playground set up appropriately for the age and skill level of the skiers.

Skill	Description	Time
Ski Play (to warm up)	Varied speeds.	5 min.





<p>Balance and Agility</p>	<p>Poison Peanut Butter: The skier first takes a step to one side, and then the other, keeping only one ski on the snow at a time. “Quick, don’t let the peanut butter stick”.</p>	<p>5 min.</p>
<p>Diagonal Stride (with poles) (Review)</p>	<p>The coach demonstrates and reviews key points.</p> <p>Skiers ski a short trail while the coach provides instruction, feedback and encouragement on a one-on-one basis. 50% with poles and 50% without them.</p>	<p>15 min.</p>
<p>Game Time</p>	<p>Clothes Pin Tag: This game is played in a ski pole circle. Choose three “Rabbits” and give the rest of the group three clothes pins each. The winner is the person who can pin a clothes pin on the collar or hood of each of the “Rabbits”. Note: After a skier pins a “Rabbit”, he/she has ten seconds to move away. Clothes pins should be coloured to confirm who has actually left their clothes pin on a Rabbit. You will need several colors, so you may need to paint some pins in order to have enough variety. No poles.</p>	<p>10 min.</p>
<p>Double Poling (Review)</p>	<p>Coach demonstrates and reviews key points. Refer to section 4.3.1 for detailed information.</p>	<p>5 min.</p>
<p>Balance and Agility</p>	<p>Hinge Hop: While skiing down a gentle slope skiers hop, lifting their ski tails and leaving their tips on the snow.</p> <p>Terrain Jump: Using the assistance of their poles skiers perform a small upward and forward jump, tucking their knees up toward their chest.</p>	<p>10 min.</p>





Snowplow Turns (Review)	<ol style="list-style-type: none">1) Coach demonstrates and reviews key points.2) Skiers practise Snowplow Turns by skiing through a series of slalom gates.3) Repeat by skiing through the gates in the opposite direction.	10 min.
Ski Play	Adventure Trail: Set up a special course on the ski playground, about 500 or 700 metres in length with uphill, downhill, flats and bumps, utilizing the different techniques – Free Skate, Herringbone, Side Stepping, Snowplow Turn, etc. The pirate's treasure – caches of goodies stashed at different points along the route (one per skier at each cache) will make the journey more exciting.	20 min.
Wrap Up (in day lodge)	Wrap up with a short information session explaining the importance of drinking fluids when physically active. Demonstrate with a sample water bottle and water bottle holder. Conclude the session with hot chocolate, the treasure findings, and a short social time at the day lodge.	15 min.





PRACTICE PLAN 14 (LEVEL 2 – ON SNOW)

SKILL EVALUATION SESSION – CLASSIC TECHNIQUES

Specific Objectives:

- 1) For the skier to be able to apply the classic technique skills learned during the season, while skiing on a ski trail.
- 2) Review and evaluate skiers for year-end skill awards.

Key Teaching Points:

- Prepare a trail for the “Adventure” ahead of time. Set up stations that require the skiers to use the skills they have learned during the season, and on which they will be evaluated. It may be best to close the trail off from the public, depending on the features you set up for the session.
- When evaluating the skiers, the emphasis should be on the successful accomplishment of a skill. The standard should be achieved only if it is truly deserved.

Teaching Aids Needed:

- A good imagination.
- Various pieces of equipment and signs to prepare the trail.
- Extra help from parents or other coaches.
- Level 2 Skill Criteria from section 4.3.3; Level 2 Skills Checklist from section 4.3.4.
- Clipboard and paper with plastic protection; pencil.
- Nature and environment information from Section 5.2.

Skill	Description	Time
Ski Play (to warm up)	Varied speeds	5 min.





Assess Level 2 Skills	<p>The Adventure: The coach takes the group on a ski on an easy terrain trail that is approximately one or two kms in length. Describe it as the “Trip Around the World.” Vary the “theme” from the previous year so that this adventure is a trip into the unknown.</p> <p>During the session, coaches evaluate the skiers’ skills and record their evaluation on the Skills Checklist.</p>	45 min.
Ski Play	Ski playground under supervision of the coaches. Some one-on-one instruction can be provided in areas where skiers need improvement to meet the skill criteria.	30 min.
Wrap Up (in day lodge)	Conclude the session with hot chocolate, snacks and a short social time at the day lodge. Remind the group to come prepared to practise both skating and classic technique at the next practice session.	15 min.





PRACTICE PLAN 15 (LEVEL 2 – ON SNOW)

Specific Objectives:

- 1) Work with individual skiers to improve classic technique skills that are below Level 2 standard.
- 2) Continue to evaluate skiers for year-end skill awards.
- 3) Review and evaluate Free Skate skills at Level 2 standard.

Teaching Aids Needed:

- Appropriate video/DVD to show the skiers what they can achieve if they continue to improve their ski skills, and to inspire them to work towards this goal.
- Ski playground area set up appropriately for the age and skill level of the skiers.

Skill	Description	Time
Observe Technique Skills	Video presentation in day lodge.	20 min.
	Skiers prepare for on-snow session, classic technique	10 min.
Ski Play and Work on Skills	<ol style="list-style-type: none"> 1. Skiers use ski playground under the supervision of the coaches. 2. Coach demonstrates and goes over key points (with individual skiers) of skills that have been identified as requiring improvement. One-on-one basis. 3. Skiers change their equipment/prepare their skis for a skating technique session with the help of the coaches. 4. Coach evaluates the skiers' Free Skate skills and records their evaluation on the Skills Checklist. 	50 min.
Wrap Up (in day lodge)	Conclude the session with hot chocolate, snacks and a short social time at the day lodge.	15 min.





PRACTICE PLAN 16 (LEVEL 2 – ON SNOW)

YEAR END ACTIVITY

Specific Objectives:

- 1) Have fun.
- 2) Encourage teamwork through adventurous, cooperative activities.
- 3) Wind up the season ski activities.
- 4) Recognize enthusiasm, effort, skill achievement and respect for others.

Teaching Aids Needed:

- Technique and Program Awards, Progress Reports.
- This depends entirely on the activities that are used.
- Refer to sections 4.3 and 5.5 of the Introduction to Community Coaching Reference Material, and sections 4.3.9 and 8.3 of this manual for some ideas for suitable activities.





5.5 Practice Plans: FUNdamentals Stage of Development - Level 3

Points to keep in mind in addition to those listed in sections section 5.2, ,5.3 and 5.4.

- ❑ The program should offer a total of 40 sessions with a minimum of two per week over a period of 18-20 weeks. Practice sessions begin in mid October.
- ❑ Practice sessions should begin in October. Refer to section 5.1.2 for more information, including samples of age appropriate pre-ski season practice sessions.
- ❑ Practice sessions on snow should be approximately 75 minutes in length, followed by 20 minutes of supervised “play time” on a ski trail or at the ski playground. Increase the wrap-up period to 15 minutes.
- ❑ As much as possible, the focus should be on one technique at a practice session, either classic or skating. Alternate between the two so that the skiers are exposed to both techniques equally (50-50). During the Wrap Up, inform the group as to the equipment needed for the next session, and follow up with an email to the parents.
- ❑ In general, poles should be used when learning/practising Level 3 skills.
- ❑ Wrap up the initial session with a short talk explaining the Program Awards and other administrative or logistical program details. Coaches meet parents. Conclude the session with hot chocolate, snacks and a short social time.

The first eleven practice plans for Level 3 should be for pre-ski season practice sessions. The following practice plans are for the on-snow sessions only.





PRACTICE PLAN 12 (LEVEL 3 – INDOORS)

SKI PREPARATION SESSION

Specific Objectives:

- 1) Teach skiers that good ski-care habits and appropriate ski preparation will result in positive ski experiences.
- 2) Review the basic steps of base preparation.
- 3) Review and introduce the basic steps of grip wax application.
- 4) Introduce skating equipment.
- 5) Introduce how to prepare a classic ski for a skating session.

Note: Advise skiers to bring their classic and skating equipment (if they have skating equipment) to this session.

Key Teaching Points:

Base Preparation and Application of Grip Wax

- ✓ Review what was covered the previous year (Practice Plan 3, Level 2..
- ✓ Increase the level of information on base preparation and the application of grip wax.
- ✓ Increase the skiers' level of responsibility when they prepare their own skis.

Ski Equipment

- ✓ Explain the distinctions between classic and skating equipment.
- ✓ Discuss what a skier needs to do in order to use classic skis for skating purposes.
- ✓ Demonstrate how a classic ski is prepared for skating technique.

Teaching Aids Needed:

- A suitable room to hold a ski preparation session.
- Set tracks close to the room so that the skiers can test their skis (if held during the winter season).
- An appropriate number of coaches/parents to provide close supervision.
- Ski forms and supplies of tools, etc.
- Refer to section 3.5 of the Introduction to Community Coaching Reference Material or section 7 of this manual for detailed information.

Ensure adequate supervision for all ski preparation sessions!

Conclude the session with hot chocolate, snacks and a short video.





PRACTICE PLAN 13 (LEVEL 3 – INDOORS)

WINTER SAFETY SESSION

Cross-country skiing is an outdoor winter activity; therefore, learning about winter safety is an essential part of a skill development program. Note that it is important to cover this aspect of the program before young skiers strike out independently and take off for the ski trails to discover skiing on their own, without adult supervision.

Specific Objectives:

- 1) Provide skiers with a basic understanding of winter safety as it pertains to cross-country skiing.
- 2) Teach skiers how to dress appropriately for different cross-country ski activities.
- 3) Teach skiers to recognize the symptoms of frostbite and hypothermia, and what steps they should take if this happens to them or to a team mate.
- 4) Introduce important nutrition and rehydration principles for cross-country skiing situations.

Teaching Aids Needed:

A suitable room to hold a session on winter safety.

Help from parents.

Refreshments corresponding to the lesson on nutrition and rehydration.

Presentation equipment and materials as needed - i.e. examples of appropriate clothing, water bottle/holders, etc.

Video/DVD.

Refer to the Introduction to Community Coaching Reference Material (sections 3 and 6) for information on winter safety.

Conclude the session with a good video/DVD on nutrition, winter safety, Canada's National Cross-Country Ski Team or similar topic, and appropriate refreshments.





PRACTICE PLAN 14 (LEVEL 3 – ON SNOW)

Specific Objectives:

- 1) Have FUN!
- 2) Develop and improve the skier's balance and agility.
- 3) Assess general ski abilities to ensure skiers are in the appropriate group.
- 4) Assess ski equipment to determine if appropriate for Level 3 skill development.
Provide feedback to parents if equipment is inadequate.
- 5) Review Snowplow Turn without poles.

The skier will require ski equipment for classic technique, including poles.

Teaching Aids Needed:

- Tracks set for classic technique.
- Ski playground set up for the age and skill level of the skiers.
- Help from other coaches.
- Name tags (masking tape and marker) to identify the skiers.
- Extra poles for the slalom course.
- Coloured sticks.

Skill	Description	Time
Ski Play (to warm up)	Varied speeds.	5 min.
Balance and Agility	<p>Marching Soldiers: Skiers walk on one spot, lifting knees high in front of chest.</p> <p>Flea Leaps: Skiers jump into the air (on their skis) and land softly in a balanced position. Knees should be bent when landing.</p> <p>One-Leg Pops: Skiers pop/spring off one leg, which is bent, and then land on it. Alternate legs.</p>	5 min.





<p>Assess Level 2 Skills</p>	<p>Follow the Leader: The skiers follow one of the coaches who leads them through a number of techniques as they move through the ski playground.</p>	<p>20 min.</p>
	<ol style="list-style-type: none"> 1) Have skiers Diagonal Stride – Gliding Step. 2) Have skiers Double Pole. 3) Have skiers Herringbone up a small hill. 4) Have skiers Free Glide back down the hill. 5) Have skiers Herringbone up a long slope, medium gradient. 6) Have skiers Snowplow Stop, Half-snowplow Brake and Snowplow Turn coming down the hill. <p>During this exercise the skiers are assessed by the coach.</p>	
<p>Snowplow Turn</p>	<p>Coach demonstrates and reviews key points. Refer to Practice Plan 12 – Level 2 and section 4.3.3 for detailed information.</p>	<p>10 min.</p>
<p>Game Time</p>	<p>Snowplow without Poles: The coach sets up a slalom course on the hill as per the diagram. Poles are staggered three/four metres apart. The distance between two poles on the same side would be about five metres. Skiers ski down the hill to the inside of each pole and reach out and try to touch the pole as they go by.</p> <div style="text-align: center;">  </div> <p>Figure 5.4</p>	<p>20 min.</p>





Game Time	Pick Up Sticks: Skiers start at bottom of a hill. They ski up the hill using the Herringbone technique and then Free Glide back down. Parallel to the tracks going down the hill there are sticks lying flat on the snow. As the skiers come down hill they try to pick up the sticks. Add one or two bumps on the downhill for the skiers to go over or jump off.	15 min.
Ski Play	Skiers use the ski playground under the supervision of the coaches. Some one-on-one instruction.	20 min.
Wrap Up	Conclude the session with hot chocolate, snacks and a short social time at the day lodge.	15 min.





PRACTICE PLAN 15 (LEVEL 3 – ON SNOW)

Specific Objectives:

- 1) Initiate a routine in which skiers test and adjust their grip waxes prior to a practice session when classic technique is being used.
- 2) Teach the skiers how to adjust their own pole straps.
- 3) Review Diagonal Stride with poles.
- 4) Review Herringbone without poles.
- 5) Review Free Glide.
- 6) Review Double Poling.

The skier will require ski equipment for classic technique, including poles.

Key Teaching Points:

Use of Pole Straps

- ✓ The hand passes through the strap from underneath and rests on top of it.
- ✓ Adjust the strap so the top of the pole fits between the thumb and forefinger when the hand is extended backwards.
- ✓ The thumb should rest on the lower strap (left and right poles).
- ✓ Common errors:
 - the hand passes through the strap from the top side.
 - the ski strap is too long, so the skier has to physically hold it at all times to control it.

Teaching Aids Needed:

- Sufficient parallel set tracks for Scooter games.
- Ski playground set up for the age and skill level of the skiers.
- Cones or other markers.
- Help from other coaches.

Skill	Description	Time
Ski Play (to warm up)	Varied speeds.	5 min.





Balance and Agility	<p>Sizzling Snow: While remaining in one place the skiers step from ski to ski, keeping only one ski on the burning snow at a time. Have the skiers “hiss” as the snow “burns their skis”.</p> <p>The Runner: Skiers run in place on their skis, changing the tempo from slow to fast. Next the skiers walk on one spot extending their leg backwards. Skiers then balance on one leg with the other extended backwards, holding that position for three seconds. Alternate legs.</p>	5 min.
Diagonal Stride (with poles) (Review)	Coach demonstrates and reviews key points. Refer to section 4.3.3 and Practice Plan 9 (Level 2. for more information.	10 min.
Game Time	<p>Scooter Side Car: The coach pairs up the skiers according to their height. Skiers remove the ski opposite to the one their partner removes, and position themselves behind the start line. The partners stand side by side with their arms around shoulder and waist, and their free foot on the inside. When starting, the partners propel themselves forward by kicking at the same time. Emphasize how far the skiers can glide in a single kick. Alternate skis and repeat.</p>	10 min.
Herringbone and Free Glide (without poles) (Review)	Coach demonstrates and reviews key points. Refer to section 4.3.3 and Practice Plans 5 and 10 (Level 2. for more information.	10 min.





Game Time	Red Light, Green Light: The coach is the policeman, and is positioned at the top of the hill. The skiers are positioned at the bottom of the hill, spread out behind the start line, and facing the policeman. When the policeman says “green light” the skiers Herringbone up the hill. When the policeman says “red light” the skiers stop. Once they reach the top of the hill they Free Glide back to the bottom. When caught moving on a red light (going up or down), skiers have to sidestep back to the start line at the bottom of the hill.	10 min.
Double Poling (Review)	Coach demonstrates and reviews key points. Refer to section 4.3.3 and Practice Plan 9 and 10, Level 2 for detailed information.	10 min.
Game Time	Chain Tag: Establish a playing area with boundaries, with one skier as “it”. When “it” tags another skier, they hold hands and try and catch others. The skiers in the chain are not allowed to let go hands or move out of bounds, so the group must work cooperatively as the chain gets longer.	15 min.
Ski Play	Skiers use the ski playground under the supervision of the coaches. Coaches provide some one-on-one instruction.	20 min.
Wrap Up	Conclude the session with hot chocolate, snacks and a short social time at the day lodge.	15 min.





PRACTICE PLAN 16 (LEVEL 3 – ON SNOW)

CHRISTMAS ACTIVITY

The period leading up to Christmas provides opportunities for a special activity that can be implemented with the minimum amount of preparation, while offering FUN and excitement for the participants. A Christmas Activity might be as simple as a practice session using games that fit well with a Christmas theme: for example all the coaches dressed as Santa's helpers; or Christmas goodies with hot chocolate at the day lodge following practice. This activity would usually be coordinated for all the ski "groups" by the SDP Programmer. Refer to the Introduction to Community Coaching Reference Material (section 5.5) and section 4.3.9 of this manual for more information.

Specific Objectives:

- 1) Develop and improve the skier's balance and agility.
- 2) Through the use of games put into practice skills learned during regular practice sessions.
- 3) Have FUN!

Key Teaching Points:

- Plan for the activity and, if necessary, prepare the setting ahead of time.
- Provide suitable coaching support for the activity that has been selected.
- No formal ski instruction.
- Use opportunities for one-on-one technique instruction.

Teaching Aids Needed:

- Extra help from parents and other coaches.
- Depends on the activity.





PRACTICE PLAN 17 (LEVEL 3 – ON SNOW)

Specific Objectives:

- 1) Develop and improve the skier's balance and agility.
- 2) Review and introduce Free Skate.
- 3) Review Half-Snowplow Braking.
- 4) Develop and improve Snowplow Stop.

The skier will require ski equipment for skating technique, including poles.

Key Teaching Points:

❑ Free Skate

- ✓ Skier stands in Ready Position, forming a “V” with the skis, with tips apart and tails together.
- ✓ Skier bends left knee and ankle, pushing off with the left leg and transferring his/her weight onto the right ski.
- ✓ Skier's right hip and shoulder are aligned over right ski. As the glide slows, the skier flexes the right knee and ankle and pushes off the right ski so his/her weight is transferred to the left ski.
- ✓ Skier's left shoulder and hip align over left ski.
- ✓ Skier pushes off gliding ski by edging inside ski.
- ✓ Arms swing comfortably opposite of leg stride and in direction of gliding ski.
- ✓ Common errors:
 - skier keeps centre of gravity (mainly body weight) between the skis.
 - the ski slides out when pushing (does not edge ski).
 - skier is unable to glide on one ski (lack of balance).
 - skier does not glide equally on right and left skis.

❑ **The Forward Lean.** This exercise can be inserted into any practice where skating technique is being used. It is the same exercise that is used when introducing the Diagonal Stride. It can be done at the day lodge if that makes the logistics easier:

- ✓ To help develop the feel of an appropriate forward position, have skier take off skis and stand, in ski boots, about 40 cm from a wall.
- ✓ Skier keeps upper body straight and gradually leans forward by bending at the ankles and knees. Skier supports body weight on the wall with hands.
- ✓ Skier's knees and middle of hips should line up over the toes.
- ✓ Skier's heels should remain on the ground.





- ✓ Move around the group and check for proper positioning.

Teaching Aids Needed:

- Cones or other markers.
- Grooming for skating technique.
- Help from parents and other coaches.

Skill	Description	Time
<p style="text-align: center;">Ski Play (warm up)</p>	<p style="text-align: center;">Varied speeds.</p>	<p style="text-align: center;">5 min.</p>
<p style="text-align: center;">Balance and Agility</p>	<ol style="list-style-type: none"> 1) Skiers stand in place with skis in a “V” position. 2) Skiers balance on one ski, and touch the other ski with their hand. 3) Next the skiers balance on the other ski and touch the first ski with their hand. 4) Skiers edge the inside of one ski and then the other. 5) Repeat several times, occasionally edging both skis at the same time. 6) Skiers edge skis and sidestep. 7) Skiers sidestep or hop sideways as far as they can to see who can make the biggest mark in the snow when pushing off. Repeat several times and then reverse direction. 8) Skiers sidestep or hop sideways and slightly forward as far as they can. Emphasize turning the body in the direction of the hop and gliding after the hop. 	<p style="text-align: center;">10 min.</p>





<p>Free Skate (Review and Introduce)</p>	<ol style="list-style-type: none"> 1) Coach demonstrates and reviews key points. 2) Skiers skate in a circle 10 metres in diameter, pushing/skating with one leg and gliding with the other. 3) Emphasize edging the skating ski (make big marks in the snow). 4) Emphasize shifting weight from the skating ski to the gliding ski. 5) Emphasize transferring the body weight from skating ski to gliding ski, and back. 6) Repeat in other direction. 	<p>10 min.</p>
<p>Game Time</p>	<p>Figure 8 Relay: Using cones, set up two figure of eight “courses” for the skiers to skate around. Break the group into two teams and use the course for relays. Repeat. Change direction and repeat. When the skiers are competent with this course, challenge them by reducing the size of the loops.</p>	<p>10 min.</p>
<p>Game Time</p>	<p>British Bulldog: The Bulldog is positioned in the middle of a flat open area, with the rest of the skiers behind a line at one end. At a command from the coach, the skiers try and cross to the line at the other side of the area without being tagged. If tagged, a skier becomes another Bulldog and helps the first Bulldog to tag skiers.</p>	<p>10 min.</p>
<p>Half-Snowplow Braking (Review and Introduce)</p>	<p>Coach demonstrates and reviews key points. Refer to section 4.3.3 and Practice Plan 10 (Level 2. for more information.</p>	<p>10 min.</p>





Game Time	Downhill Lanes: Set up two downhill courses. Set a laneway shaped like a “V” pointing up the hill, and another pointing down the hill. Use coloured water to mark the lines. Skiers begin at the top of the hill and ski down, turning as close to the line as possible without touching it or going outside of it. One course becomes narrower and narrower, and the other course gets wider and wider. Alternate courses.	10 min.
Snowplow Stop (Review)	Coach demonstrates and reviews key points. Refer to section 4.3.3 and Practice Plan 9 (Level 2. for more information.	10 min.
Explore Ski Trail	Free Skate technique. Skiers explore a designated trail under the supervision of the coaches. Skiers hold their poles, but do not use them unless they need them to Herringbone up a hill. The coaches provide some one-on-one instruction.	20 min.
Wrap Up	Conclude the session with hot chocolate, snacks and a short social time at the day lodge.	15 min.





PRACTICE PLAN 18 (LEVEL 3 – ON SNOW)

Specific Objectives:

- 1) Develop a routine in which skiers test and adjust their grip waxes prior to a practice session when classic technique is being used.
- 2) Develop and improve the skier's balance and agility.
- 3) Develop and improve skier's weight shift and glide in Diagonal Stride with poles.
- 4) Introduce Free Glide with poles.

The skier will require ski equipment for classic technique, including poles.

Key Teaching Points:

Free Glide (with poles)

- ✓ Arms and hands stay well in front of body.
- ✓ Pole hands in front of body, tips behind body, and pole shafts pointing down and backward.
- ✓ Upper body position should be upright, though many skiers will want to do the more advanced tuck position. If the latter is the case, the skiers should show you they can move back and forth between upright and tuck positions.
- ✓ Common errors:
 - knees and ankles are straight.
 - hands are close to hips.
 - upper body position is bent forward – often associated with straight legs and ankles.

Teaching Aids Needed:

- Sufficient parallel set tracks to play Scooter games.
- Ski playground set up for the age and skill level of the skiers.
- Help from parents and other coaches.
- Markers.

Skill	Description	Time
Ski Play (to warm up)	Varied speeds.	5 min.





<p>Balance and Agility</p>	<p>Scooter Freeze Tag: One coach acts as the “chaser”. Skiers remove one ski. They freeze on one leg when tagged by the chaser. Frozen skiers may be unfrozen if tagged by a free skier. Alternate skis after five minutes.</p>	<p>5 min.</p>
<p>Diagonal Stride (with poles) (Review)</p>	<ol style="list-style-type: none"> 1) Coach demonstrates and reviews key points. Refer to section 4.3.5 for details. 2) Skiers practise it. 3) Coach demonstrates forward lean. 4) Skiers practise it. 5) Skiers balance on right leg, with forward lean. The left leg is extended backwards. 6) Skiers plant left pole with slant opposite right foot. Lift pole and repeat several times. Alternate legs. 7) Skiers Diagonal Stride with emphasis on proper pole plant. <p>Scooter Glide: Skiers remove one ski and practise scootering and gliding on one ski for as long as possible. The contest is to see who can glide the longest. A variation of the game is to have the skiers count the number of pushes they require to cover the distance between the start line and finish line. This game encourages a more powerful push and a better glide.</p>	<p>15 min.</p>
<p>Game Time</p>	<p>Lemans Start Pole Relay: Set up two exchange “zones”. Skiers take their poles to the first exchange zone, leave them there and return to the start line. When the relay begins, the skiers ski to the first exchange zone, pick up their poles, hold them at the balance point, and then ski to the second exchange zone. At the second exchange zone, the skiers put their poles on and ski to the finish line. Vary the emphasis between speed and the longest strides.</p>	<p>15 min.</p>





<p>Free Glide (with poles) (Introduce)</p>	<ol style="list-style-type: none"> 1) Coach demonstrates and reviews key points. Refer to section 4.3.5 for details. 2) Skiers Free Glide down a slope in set tracks. 3) Skiers Free Glide down a slope with bumps. 4) Skiers Free Glide down a slope with bicycle bumps. 	<p>15 min.</p>
<p>Game Time</p>	<p>Cops and Robbers: One coach is the “cop”. The skiers are “robbers”. The robbers are safe as long as they are in a marked area (hideout). However, they cannot stay in the hideout for more than five seconds. One of the marked areas is a prison. When robbers are tagged by a cop, they must go to prison. When captured robbers are tagged by a free robber, they can go free.</p>	<p>10 min.</p>
<p>Game Time</p>	<p>Mines: Spray dots of coloured water at various spots in the set tracks. Don’t spray the left and right track at the same place. Skiers then ski down the track, lifting one ski over the “mine” while gliding on the other ski.</p>	<p>10 min.</p>
<p>Ski Play</p>	<p>Skiers use the ski playground under the supervision of the coaches. Coaches provide some one-on-one instruction.</p>	<p>20 min.</p>
<p>Wrap Up</p>	<p>Conclude the session with hot chocolate, snacks and a short social time at the day lodge</p>	<p>15 min.</p>





PRACTICE PLAN 19 (LEVEL 3 – ON SNOW)

Specific Objectives:

- 1) Develop and improve the skier's balance and agility.
- 2) Review and introduce Free Skate.
- 3) Introduce Diagonal Skate.
- 4) Introduce One Skate
- 5) Review Snowplow Turn.

The skier will require ski equipment for skating technique.

Key Teaching Points:

Free Skate

- ✓ Skier forms “V-shape” with tips apart and tails together.
- ✓ Skier glides on right and left ski while skiing on flat terrain.
- ✓ Hips and shoulder (on same side) align over glide ski.
- ✓ Slightly bent knee when gliding, flexes ankle during push-off.
- ✓ Slight forward lean in upper body.
- ✓ Skier's unweighted foot recovers to a position underneath and beside the other foot.
- ✓ Common errors:
 - ski stops when weighted.
 - because of balance problems, skier cannot get the unweighted foot under the body.

Diagonal Skate

- ✓ Skier utilizes this technique to climb a moderate slope. Action is similar to a “gliding” Herringbone.
- ✓ By alternating pushes with the arms and legs skier glides up the hill from ski to ski. Each pole and the opposite ski touch the snow at the same time.
- ✓ The gliding skis should be kept fairly flat on the snow, not edged until push off.
- ✓ Hands are kept close to the body during the initial part of the arm push.
- ✓ Common errors:
 - skis stop before the weight shifts off it.
 - arm work is not close to the body.

One Skate

- ✓ While gliding on the right ski, skier begins Double Poling.
- ✓ Right hip and shoulder are over gliding ski until the leg push is initiated. During the





Double Poling action, the skier begins to transfer weight onto the left ski by edging the glide ski and pushing off it.

- ✓ As the skier moves onto the left ski, the body becomes more upright and recovers both the arm and the now unweighted foot.
- ✓ The skier demonstrates some upper body movement when poling.
- ✓ Common errors:
 - skier demonstrates offset timing – poling and start of glide occur at the same time. This is a very common problem if the skier has been doing offset on own.
 - body weight remains balanced between the two skis, and not balanced over the individual gliding ski.
 - very rushed turnover – cannot take time because of poor balance.
 - uses only the arms when poling.

Teaching Aids Needed:

- Tracks set for classic technique.
- With a shovel, build a hump in the middle of a hill/slope. The hump should be designed to go up the length of the hill. This should be done a day in advance to ensure that the snow sets up properly.
- Help from parents or other coaches.
- Cones and other markers.
- Enough socks with tennis balls for each skier in the group.
- Coloured ribbons or other materials to distinguish one group of skiers from another.
- Soccer ball.

Skill	Description	Time
Ski Play (to warm up)	Varied speeds.	5 min.
Balance and Agility	Pendulum Swings: Skiers stand on one leg while swinging the other leg back and forth. Begin slowly, and then increase the tempo.	5 min.





	<p>Combo Swing: Skiers stand on one leg while swinging the other leg back and forth. When the skiers stand on their left leg, the left arm swings in the same direction as the right leg and the right arm swings in the opposite direction.</p>	
<p>Free Skate (Review and Introduce)</p>	<p>Coach demonstrates and reviews key points. Refer to section 4.3.5 and Practice Plan 17 (Level 3. for additional information.</p> <p>Towing with Pole: The coach removes skis and gives a pole handle to one of the skiers. The coach pulls the skier forward. The skier skates. Emphasize edging ski, shifting weight, and bringing the foot under the body. Skiers then try to Free Skate without being towed.</p>	10 min.
<p>Game Time</p>	<p>Crows and Cranes. Divide the group into two teams: “Crows” and “Cranes”. Use a crepe paper flag, or have all of one team wear toques. On a signal, the entire group scatters over the playing area. On a signal from a whistle, the skiers freeze where they are. The leader now calls either “Crows” or “Cranes”. The team called is chased by the other team - e.g. if “Crows” is called, the “Cranes” chase the “Crows”. If caught, a Crow becomes a Crane. Freeze, chase, freeze, chase and so on, until one team is absorbed.</p>	15 min.
<p>Diagonal Skate (Introduce)</p>	<ol style="list-style-type: none">1) Coach demonstrates and reviews key points.2) Skiers Herringbone up a hill with the hump staying underneath their body.3) Repeat with skis “sliding down hump” but uphill.4) Repeat, but emphasizing weight shifting off the ski before it stops. Have the skiers try this without poles.5) Repeat with emphasis on diagonal arm work.6) Emphasize stepping up hill.	10 min.





<p>One Skate (Introduce)</p>	<ol style="list-style-type: none"> 1) The coach demonstrates One Skate. 2) The coach demonstrates each of the following, with the skiers trying it before moving on to the next progression. 3) In a flat area with no tracks, Double Pole on an angle (30 – 45 degrees off in the direction you want to go in), glide to a stop, step 90 degrees in the opposite direction, Double Pole, glide to a stop, etc. 4) Repeat as above, but halfway through the Double Poling action, step in a new direction. 5) Repeat as above, but lift the inside ski off the snow. 	<p>10 min.</p>
<p>Game Time</p>	<p>Fetch: A start line is marked on one side of the field, and a finish line on the other. Each skier has a sock with a ball in it. The skiers line up at one edge of the field and throw the sock as far down the field as they can. They One Skate as fast as they can to the sock, and execute a full Star Turn (tails apart) around the sock. Skiers then pick up their socks and throw them further down the field towards the finish line. This continues until the sock lands past the finish line. Option: Have a basket at the end of the field rather than a finish line.</p>	<p>10 min.</p>
<p>Snowplow Turn (Review)</p>	<ol style="list-style-type: none"> 1) Coach demonstrates and reviews key points. Refer to section 4.3.3 for detailed information. 2) Set a cone on slope of hill. 3) Skiers try single turn to right or left of cone. 4) Set two lines of cones with one curve (either right or left) where skiers have to stay inside the cones. Repeat in other direction. 5) Change the severity of the curve and repeat. 6) Set a slalom course where the skiers have to link several turns in opposite directions together. If the skiers take the turns very wide, add cones to make a laneway to stay in. 	<p>10 min.</p>





Ski Play	Skiers use the ski playground under the supervision of the coaches. Coaches provide some one-on-one instruction.	20 min.
Wrap Up	Conclude the session with hot chocolate, snacks and a short social time at the day lodge.	15 min.





PRACTICE PLAN 20 & 21 (LEVEL 3 – ON SNOW)

HOLIDAY SKI CAMP

An excellent way to enhance your skill development program is to include an overnight ski camp in your plans for the season. Children can be introduced to a ski camp experience when they are eight years of age, and the Christmas holidays provide an opportune time for this to take place.

Ideally the camp will be a club-organized program that can be adapted to the needs of the different age groups. To meet the primary objectives of the activity, it is important that this is an overnight camp experience. In addition, because of the age of the skiers, it may be preferable to begin the camp at noon on day one, and end in early afternoon on day two. Be cautious about using one-day camps for skiers at this age – they may be viewed as one never-ending practice session.

Specific Objectives:

- 1) Provide an opportunity for children to develop friendships with other skiers their own age.
- 2) Team building.
- 3) Develop and improve ski skills learned during regular practice sessions.
- 4) Have FUN!

Key Teaching Points:

- Keep the children active, but not necessarily with ski activities.
- Ski activities should be short and varied.
- The children will require close supervision because of their age.
- All activities need to be appropriate for the age and skill level of the skiers.
- Utilize every opportunity to encourage the development of independent athletes – ski care, preparing meals, eating appropriate foods, clean up duty, curfew, dressing appropriately for each activity, etc.
- Keep in mind that a program that is too difficult will discourage future involvement.

Teaching Aids Needed:

- Competition Coaching - Introduction Reference Material.
- Suitable coaching support for the activity that has been selected.
- Extra help from parents and other coaches.
- Depends on the activity.

**The ultimate objective is to motivate skiers to learn more,
ski more and further participate in the sport.**





PRACTICE PLAN 22 (LEVEL 3 – ON SNOW)

NEW YEAR ACTIVITY

Participation in a club activity/event exposes young skiers and their families to the wide range of programs that clubs offer, as well as the family orientation of the sport. If you live in a community that doesn't offer programs of this kind, refer to section 5.5 of the Introduction to Community Coaching Reference Material for some ideas and create a "special activity" of your own. This could be a Moonlight Ski, a Lantern Ski, Turkey Glide, a trek to a cabin/lake for lunch and some games, or a similar activity.

Specific Objectives:

- 1) Introduce skiers to the club at large.
- 2) Introduce skiers to a new type of cross-country ski experience.
- 3) Practise skills learned during regular practice sessions.
- 4) Have FUN!

Key Teaching Points:

- Plan for the activity and, if necessary, prepare the setting ahead of time.
- Provide suitable coaching support for the activity that has been selected.
- No formal ski instruction.
- Use opportunities for one-on-one technique instruction.

Teaching Aids Needed:

- Extra help from parents and other coaches.
- Depends on the activity.





PRACTICE PLAN 23 (LEVEL 3 – ON SNOW)

Specific Objectives:

- 1) Develop and improve the skier's balance and agility.
- 2) Develop and improve skier's weight transfer and glide in Diagonal Stride with and without poles.
- 3) Introduce Kick Turn with poles.
- 4) Introduce Step Turn with poles.

The skier will require ski equipment for classic technique.

Key Teaching Points:

Kick Turn (with poles)

- ✓ One pole should be to the rear of the skis and the other to the front, in positions that will not obstruct the kick movement.
- ✓ Skier can turn both directions between 90-180 degrees.
- ✓ Common errors:
 - poles get in the way.
 - skier relies on poles for balance.
 - skier steps on own ski.

StepTurn (with poles)

- ✓ Skier glides down a small tracked hill in Ready Position.
- ✓ Skier steps out of the track, in a new direction, with some small, quick steps, and continues to glide in the Ready Position.
- ✓ Skier can change direction both left and right.
- ✓ Common errors:
 - one or both hands beside or behind hip.
 - doesn't transfer weight, and is unable to get ski out of track. If gets ski out of track, is trapped between skis.

Teaching Aids Needed:

- Sufficient sets of parallel tracks to play Scooter games.
- Help from parents or other coaches.
- Cones or other markers.





Skill	Description	Time
Ski Play (to warm up)	Varied speeds.	5 min.
Balance and Agility	Freeze Scooter Tag: One coach acts as the “chaser”. Skiers remove one ski. They freeze on one leg when tagged by the chaser. Frozen skiers may be unfrozen if tagged by a free skier. Alternate skis.	5 min.
Diagonal Stride (with and without poles) (Review)	Coach demonstrates and reviews key points. Refer to section 4.3.5 for additional information. Skiers ski in tracks with one-on-one coaching as required. 50% with poles.	10 min.
Game Time	Scooter Relay: Everyone has one ski on. Divide the group into two teams. Begin on a gentle slope with at least two sets of tracks. One half of the team is placed at the top of the slope and the other half at the bottom. One skier from each team scooters up the hill (helps emphasize bent ankle and knee) and tags an uphill teammate who scooters down the hill (helps emphasize balance and glide) and tags the downhill teammate. Repeat using opposite leg.	10 min.
Kick Turn (Review)	<ol style="list-style-type: none">1) Coach demonstrates a Kick Turn without poles.2) Skiers practise the skill both to the left and the right.3) Coach demonstrates a Kick Turn with poles.4) The skier places one pole to the rear and one pole in front and tries a Kick Turn to the right.5) Repeat in the other direction.	10 min.





<p>Game Time</p>	<p>Kick Turn Relay: Set up a start and finish, with two changeover zones in between. Skiers Diagonal Stride to the first marker and complete two Kick Turns in the same direction. Next they ski to the second marker and complete two Kick Turns in the other direction. Then they ski to the finish line.</p>	<p>10 min.</p>
<p>Step Turn (Review)</p>	<ol style="list-style-type: none"> 1) Coach demonstrates on the flat, reviewing key points. 2) Skiers step to the right and left, with an emphasis on quick, small steps and maintaining a Ready Position. 3) Coach demonstrates the turn part way up a gentle slope, and reviews the key points. 4) Skiers Free Glide down the slope, taking a step to change direction when they reach the bottom. 5) Repeat, but this time take several steps when changing direction. 6) If the skiers can manage this exercise, go further up the hill to increase speed. 	<p>10 min.</p>
<p>Game Time</p>	<p>Duck, Duck, Goose: Form a circle ten metres in diameter, with the skiers facing towards the centre. One skier is on the outside of the circle, skiing behind the group and saying “Duck, Duck, Duck” as he/she touches each of the other skiers on the back. When he/she touches a skier and says “Goose”, that skier must leave his/her place. Both skiers race around the circle to see who can be the first to get to the vacant position. The first one to get there wins. The unsuccessful skier then circles behind the group saying “Duck, Duck” etc. Variation for larger groups - two skiers skiing outside the circle, going in opposite directions. May or may not choose to use poles.</p>	<p>15 min.</p>





Explore Ski Trail	Skiers explore a designated trail under the supervision of the coaches. The coaches provide some one-on-one instruction.	20 min.
Wrap Up	Conclude the session with hot chocolate, snacks and a short social time at the day lodge.	15 min.





PRACTICE PLAN 24 (LEVEL 3 – On Snow/)

Specific Objectives:

- 1) Develop and improve the skier's balance and agility.
- 2) Review Half-Snowplow Braking.
- 3) Review and introduce Free Skate.
- 4) Review and introduce One Skate.
- 5) Review and introduce Step Turn.

The skier will require ski equipment for skating technique.

Key Teaching Points:

Free Skate

- ✓ Emphasize bringing recovery leg underneath body.

One Skate

- ✓ Emphasize transferring the body weight onto the new ski, with the entire trunk moving together at the same time and the same side shoulder and hips aligned over the ski.
- ✓ Emphasize bringing recovery leg underneath body.
- ✓ Common errors:
 - weight (centre of gravity) remains between the skis with minimal weight transfer.
 - head follows or leads trunk movement from side to side.
 - poor balance does not allow recovery leg to come underneath body.

Step Turn

- ✓ Emphasize transferring weight from ski to ski.
- ✓ Introduce lifting skis out of tracks on downhills.
- ✓ Common errors:
 - keeps weight between skis and makes lifting of skis difficult. Skiers may be able to do it at low speeds but feel uncomfortable at high speeds.

Teaching Aids Needed:

- Help from parents or other coaches.
- Cones or other materials.





Skill	Description	Time
Ski Play (to warm up)	Varied speeds.	5 min.
Balance and Agility	<ol style="list-style-type: none">1) Skiers stand in place with skis in a “V” position.2) Skiers balance on one ski, and touch the other ski with their hand.3) Next the skiers balance on the other ski and touch the first ski with their hand.4) Skiers edge the inside of one ski and then the other.5) Repeat several times, occasionally edging both skis at the same time.6) Skiers edge skis and sidestep.7) Skiers sidestep or hop sideways as far as they can to see who can make the biggest mark in the snow when pushing off. Repeat several times and then reverse direction.8) Skiers sidestep or hop sideways and slightly forward as far as they can. Emphasize turning the body in the direction of the hop and gliding after the hop.	5 min.





<p>Half-Snowplow Braking (Review)</p>	<ol style="list-style-type: none"> 1) Coach demonstrates and reviews key points. Refer to section 4.3.5 for additional information. 2) Skiers stand in Ready Position in set tracks, lifting one ski up at a time and putting it back in the track. 3) Skiers Free Glide down a slope with set tracks, lifting up one ski at a time and putting it back in the track. 4) Repeat, with skiers lifting ski out of track, and placing it outside and parallel to the track. 5) Skiers lift ski out of track and put it down on an angle (tip close to the track, tail away), and then place it back in the track. 	<p>10 min.</p>
<p>Game Time</p>	<p>Cops and Robbers: One coach is the “cop”. The skiers are “robbers”. The robbers are safe as long as they are in a marked area (hideout). However they cannot stay in the hideout for more than five seconds. One of the marked areas is a prison. When robbers are tagged by a cop, they must go to prison. When captured robbers are tagged by a free robber, they can go free.</p>	<p>10 min.</p>





<p>Free Skate (Review)</p>	<ol style="list-style-type: none"> 1) Coach demonstrates Free Skate and reviews key points. 2) Skiers practise this skill. 3) Coach demonstrates bringing a foot underneath the body by clicking ski boots together. 4) Skiers practise this skill. 5) The drill below is effective if skiers are having problems transferring weight from ski to ski or excessive up and down movement of their shoulders. <p>Waiter: The coach demonstrates by holding the shaft of a ski pole, shoulder width apart, with elbows “super-glued” to the hips. When the coach glides on a ski, the same side shoulder should be positioned over the glide ski. Emphasize that the poles should be level at all times (a tray with drinks!). This drill only works if the skiers can keep their elbows on their hips.</p>	<p>10 min.</p>
<p>One Skate (Review and Introduce)</p>	<ol style="list-style-type: none"> 1) Coach demonstrates the One Skate technique. 2) Coach demonstrates each of the following steps, one at a time, with the skiers practising each one before moving on to the next one. This should be done on a flat area with no tracks. 3) Skiers Double Pole on an angle (30-45 degrees off the direction they want to go in), glide to a stop, set off 90 degrees in the opposite direction, Double Pole, glide to a stop, etc. 4) Repeat as above, but half way through the Double Poling action, the skier steps in a new direction. 	<p>10 min.</p>
	<ol style="list-style-type: none"> 5) Repeat as above, but lift the inside ski off the snow. 6) Repeat as above, but without gliding to a stop. 7) Add clicking the heels together. 	





<p>Game Time</p>	<p>Steal the Pole: Two concentric rings of ski poles are formed (inner ring – six metres; outer ring – nine metres), where the outer ring has one less pole than the number of skiers. The skiers ski around within the inner circle until the coach signals to them to dash for one of the ski poles that make up the outer circle. The skier that ends up without a pole is sent outside the outer circle and a second pole is removed. Those who were able to get a pole go back to skiing in the inner circle, and the skier who did not get a pole skis around the outside of the outer circle. At a signal from the coach, all the skiers try to reach a pole. Assuming that the skier on the outside can reach a pole before those inside the circle, there will be two skiers from inside the circle that won't reach a pole. These two then ski around the outside and those who did reach a pole continue to ski within the inner circle. Continue removing poles until the game ends.</p>	<p>20 min.</p>
<p>Step Turn (Review)</p>	<p>Coach demonstrates and reviews key points.</p> <p>First skiers try to Step Turn at the bottom of a slope.</p> <p>Next they try and Step Turn on the slope.</p>	<p>5 min.</p>
<p>Explore Ski Trail</p>	<p>Skiers explore a designated trail under the supervision of the coaches. The coaches provide some one-on-one instruction.</p>	<p>20 min.</p>
<p>Wrap Up</p>	<p>Conclude the session with hot chocolate, snacks and a short social time at the day lodge.</p>	<p>15 min.</p>





PRACTICE PLAN 25 (LEVEL 3 – ON SNOW)

Specific Objectives:

- 1) Develop and improve the skier's balance and agility.
- 2) Introduce correct relay exchanges.
- 3) Develop and improve Double Poling on flats.
- 4) Introduce Sidestep with poles
- 5) Develop and improve Half-Snowplow Braking.

The skier will require ski equipment for classic technique.

Key Teaching Points:

❑ Relay Exchanges

- ✓ Exchange must be body to body contact – preferably hand to shoulder. Exchange by having the incoming skier touch (tag) the body of the outgoing skier. Encourage the tag on the “torso”, especially the shoulder.
- ✓ The exchange must occur in a fixed area (on skis the official distance is 10 metres, but for this age level and this speed, it should be shorter).
- ✓ If the tag fails to take place, the skier must return to the exchange zone and repeat the tag before going on.
- ✓ As the skiers get more proficient at tagging, the coach can encourage the outgoing skier to start moving before getting tagged. Make sure the tag still occurs within the zone. When the skiers reach this competency level, the zone can be lengthened.
- ✓ Skier being tagged should be Double Poling.
- ✓ Common errors:
 - exchange occurs outside of zone.
 - skier makes contact with ski pole and not body to body.

❑ Side Step (with poles)

- ✓ Keep skis parallel.
- ✓ Weight and edge ski while stepping with the other ski.
- ✓ Pole handles in front of body, tips behind body (held, not planted).
- ✓ Keep skis perpendicular to Fall Line.
- ✓ Common errors:
 - skis point slightly up or down hill.
 - doesn't place ski parallel.





- Double Poling.
- plants poles on angle so pole handle is ahead of tips.

Teaching Aids Needed:

- Trails groomed for classic technique.
- Sufficient parallel tracks for the Kick Turn Relay and Relay Exchange exercises.
- Ski playground set up appropriately for the age and skill level of the skiers.
- Cones or other markers.
- Enough large soft balls for each skier in the group; basket or hoop.
- Ten 2-metre long ropes.

Skill	Description	Time
Ski Play (to warm up)	Varied speeds.	5 min.
Balance and Agility	<p>Marching Soldiers: Skiers walk on one spot, lifting knees high in front of chest.</p> <p>Flea Leaps: Skiers jump into the air (on their skis) and land softly in a balanced position. Knees should be bent when landing.</p> <p>One-Leg Pops: Skiers pop/spring off one leg, which is bent, and then land on it. Alternate legs.</p>	5 min.
Double Poling (on flats) (Review)	<ol style="list-style-type: none"> 1) Coach demonstrates and reviews key points. Refer to section 4.3.3 for additional information. 2) Skiers practise Double Poling. 3) Emphasize planting poles on slant. 	10 min.





Game Time	Kick Turn Relay – 2: Set up start and finish lines approximately 60 metres apart, with two changeover markers in between. Between the two changeover markers, set up a relay exchange zone (approx. 10 metres wide). Form two-person teams. The first team members Double Pole to the first changeover marker, complete two Kick Turns, and proceed to the relay exchange zone (still Double Poling) where they tag their team mate. The second skiers Double Pole to the second changeover marker and complete two Kick Turns before skiing to the finish line.	10 min.
Side Stepping (with poles) (Introduce)	<ol style="list-style-type: none">1) This skill is practised on a fairly steep hill.2) The coach demonstrates and reviews the key points. Refer to 4.3.1 for detailed information.3) Skiers Side Step up the hill with an emphasis on weight shift and edging skis.4) Skiers should pause periodically and lift their poles. If properly positioned they should be able to stay there without moving.5) Skiers Side Step down the hill.6) Emphasize pole handles in front, tips in back.	10 min.
Game Time	Uphill Basketball: Skiers are given a large size ball that they hold in front of their chest, using both hands. The skiers Side Step up the hill carrying the ball, and then return back down in a Free Glide, still holding the ball. At the bottom of the hill skiers throw the ball into a basket or through a hoop, depending on how the game is set up. Option: place two 2-metre long ropes perpendicular to the Fall Line for the skiers to Side Step over during the uphill portion of the game.	10 min.





<p>Half-Snowplow Braking (Review)</p>	<ol style="list-style-type: none"> 1) Coach demonstrates and reviews key points. Refer to section 4.3.3 for additional information. 2) Emphasize controlling speed by edging plow ski. 3) Skiers try to slow to a stop on the middle of a slope. 4) Skiers stand in Ready Position in set tracks, lifting one ski up at a time and putting it back in the track. 5) Skiers Free Glide down a slope with set tracks, lifting up one ski at a time and putting it back in the track. 6) Repeat, with skiers lifting ski out of track, and placing it outside and parallel to the track. 7) Skiers lift ski out of track and put it down on an angle (tip close to the track, tail away), and then place it back in the track. 	<p>5 min.</p>
<p>Mock Relay Exchange</p>	<ol style="list-style-type: none"> 1) Set up an exchange zone 10 metres in length. There should be a minimum of two sets of parallel tracks. Clearly mark the ends of the zone, as well as the area where the skiers who are waiting to be tagged should stand before they enter the exchange zone. 2) Coach demonstrates a correct tag with a partner, reviewing the key points. 3) Break the group into teams of two, with half the skiers positioned 50 metres before the exchange zone, and the other beside it. 4) Use Double Poling when first attempting this exercise. 5) There should be one "Team" per set of tracks. 6) The starting skiers Double Pole to the exchange zone and tag their partners, who then ski 50 metres beyond the exchange zone, do a Kick Turn and repeat the procedure going in the other direction. 	<p>20 min</p>





Ski Play	Skiers use the ski playground under the supervision of the coaches. Coaches provide some one-on-one instruction.	20 min.
Wrap Up	Conclude the session with hot chocolate, snacks and a short social time at the day lodge.	15 min.





PRACTICE PLAN 26 (LEVEL 3 – ON SNOW)

Specific Objectives:

- 1) Develop and improve the skier's balance and agility.
- 2) Review and introduce Free Skate.
- 3) Introduce relay exchanges.
- 4) Develop and improve One Skate.

The skier will require ski equipment for skating technique.

Key Teaching Points:

Free Skate

- ✓ Encourage starting the glide off with a flat ski, and only edging when pushing off.

Relay Exchanges

- ✓ Practise exchanges when zone is crowded.
- ✓ Emphasize the risk from ski poles, and how the poles should be handled.
- ✓ Common errors:
 - missed tag, must return to exchange zone.

Teaching Aids Needed:

- Ski playground set up appropriately for the age and skill level of the skiers.
- Brightly coloured handkerchief or surveyors' tape.
- Pirate's treasure.
- Extra help from parents and other coaches.
- Cones or other markers.

Skill	Description	Time
Ski Play (to warm up)	Varied speeds.	5 min.





Balance and Agility	Bobbing Stork: Skiers stand on one ski, bend forward at the waist, and then stand upright again with their shoulders, hips and ankles lined up one on top of the other. They appear to be bobbing like a bird on one leg. Flying Stork: Skiers leap into the air by pushing off with both legs. They land on one leg. Alternate legs.	5 min.
Free Skate (Review)	<ol style="list-style-type: none">1) Coach demonstrates and reviews key points. Refer to section 4.3.5 for additional information.2) Skiers practise the skill.3) Coach demonstrates bringing a foot underneath by clicking both heels together.4) Skiers practise this also.5) Emphasize a flat ski.	10 min.
Game Time	Catch the Dragon's Tail. The skiers in the group line up one behind one other. Eight to ten skiers is ideal. The skiers put their arms around the waist of the skier in front of them. The last skier in the line tucks a brightly coloured handkerchief into his/her back pocket or the back of the toque. To work up steam, the dragon should then make a few scary cries. At a signal from the coach, the dragon begins chasing its own tail, the objective being for the skier at the head of the line to snatch the handkerchief. When the skier at the head of the line finally captures the tail, he/she wears the handkerchief and becomes the new tail. The skier who was second from the front of the line then becomes the new leader. A variation is to have two dragons (chains of skiers) trying to catch the tail of the other.	15 min.





<p>One Skate (Introduce)</p>	<ol style="list-style-type: none"> 1) Coach demonstrates the One Skate. 2) Skiers try it, with clicking of heels. 3) Emphasize a flat ski. <p>Double Double Skate: The skiers Double Pole twice on one side before transferring weight to the other side. Repeat. If a skier is proficient and space allows, Double Pole three times, four times, etc.</p>	<p>10 min.</p>
<p>Game Time</p>	<p>Crows and Owls: The objective of this game is to work on turning from a stationary position and forward movement without poles. Form two equal teams. One team will be “Crows” and the other team “Owls”. The two teams form lines with one team facing the other. The lines need to be marked by ski poles or a similar marker at each end. The two lines should be 20 to 30 metres apart. For each team, its own line is its “home.’ The coach then makes a statement that is easily identified as either true or false. If it is true, the Owls (who are wise and honest) chase the Crows; if it is false the Crows (who are sly, devious and don’t always know the truth) chase the Owls. The team being chased must turn around and ski past the poles identifying its home line to be safe. Skiers who are tagged by a skier from the other team before they get safely home must join that team.</p>	<p>15 min.</p>
<p>Relay Exchange</p>	<ol style="list-style-type: none"> 1) Set up an exchange zone the same as for the previous session. 2) Coach demonstrates with a partner, reviewing key points. 3) This time the skiers are using skating technique. 4) Have several teams come in for an exchange at the same time. 	<p>15 min.</p>





Ski Play	Adventure Trail: Set up a special course on the ski playground, about 500 or 700 metres in length, with uphill, downhill, flats and bumps, utilizing the different techniques – Free Skate, Herringbone, Side Stepping, Snowplow Turn, etc. The pirate's treasure – caches of goodies stashed at different points along the route (one per skier at each cache) - will make the journey more exciting.	20 min.
Wrap Up	Wrap up with a short information session on the Special Activity coming up, and how to prepare for it. Conclude the session with hot chocolate, the treasure findings and a short social time at the day lodge.	15 min.





PRACTICE PLAN 27 (LEVEL 3 – ON SNOW)

CLASSIC RELAY

The purpose of this activity is to introduce young skiers to a traditional relay competition. This could be a formal inter-club competition, or it could be organized by your club/group to simulate a real event in order to teach relay rules and procedures. A formal competition is strongly recommended because it is much more exciting for the skiers and it provides an opportunity for the group to meet new ski friends.

Specific Objectives:

- 1) Have the skier involved in a special motivational activity.
- 2) Have the skier meet new ski friends.
- 3) Have the skier learn new sport skills.
- 4) Develop and improve the skier's balance and agility.

Key Teaching Points:

- Emphasize teamwork.
- Encourage and praise each child for taking part in and completing the task.
- Downplay winning, and emphasize an effective exchange, good technique and sportsmanship.
- Teach skiers the relevant rules and procedures, such as the following:
 - ✓ Start procedures for a relay competition, including the rules on changing lanes, false starts etc.
 - ✓ Rules for the exchange zone, including the correct way to tag the next skier.
 - ✓ Rules for passing other skiers on the course, etc.
 - ✓ How to know which skier on the team goes first, which second, etc.
- Ski the course with the skiers prior to the relay.
- Use the opportunity for one-on-one skill instruction.

Teaching Aids Needed:

- Refer to section 8 of this manual for tips on coaching a group at a competition.
- A wax box.
- Extra help from parents and other coaches (including transportation to and from the event).
- CCC Rules and Regulations (pertaining to relay competitions).



**PRACTICE PLAN 28 (LEVEL 3 – ON SNOW)****Specific Objectives:**

- 1) Develop and improve the skier's balance and agility.
- 2) Develop and improve Diagonal Stride with poles.
- 3) Develop and improve Herringbone with poles.
- 4) Introduce One-step Double Poling.

The skier will require ski equipment for classic technique.

Key Teaching Points: **One-step Double Poling**

- ✓ Skier pushes off the left ski and transfers all his/her weight to the right ski, while reaching forward to Double Pole.
- ✓ While upper body flexes forward in the Double Poling action, the trailing ski is recovered to a position beside the other ski.
- ✓ Weight is shifted from one ski to the other as in Diagonal Stride.
- ✓ Upper body action is trunk, then shoulders, and then elbows.
- ✓ Alternate leg kicks.
- ✓ Skier can ski 50 metres using this technique
- ✓ Common errors:
 - kick and reach forward do not occur at the same time.
 - leg is kicking back, but ski is not weighted so the leg is not effectively pushing the body forward.

Teaching Aids Needed:

- Sufficient sets of parallel tracks to play Scooter games.
- Cones or other markers.
- Help from parents and other coaches.
- Measuring tape.

Skill	Description	Time
Ski Play (to warm up)	Varied speeds.	5 min.





<p>Balance and Agility</p>	<p>Freeze Scooter Tag: One coach acts as the “chaser.” Skiers remove one ski. They freeze on one leg when tagged by the chaser. Frozen skiers may be unfrozen if tagged by a free skier. Alternate skis.</p>	<p>5 min.</p>
<p>Diagonal Stride (with poles) (Review)</p>	<p>Coach demonstrates and reviews the appropriate key points.</p> <p>Measured Scooter: Mark off one track every 0.5 metres. Mark other tracks at 0.75 metre, 1 metre and 1.25 metre intervals. Have the skiers start in the first track. If they continually glide past each marker, they move to the next track, etc. Repeat using Diagonal Stride with poles.</p>	<p>10 min.</p>
<p>Game Time</p>	<p>Wolf Ring: A defined area with both perimeter and diameter lines is established for the game. Skiing is permitted around the perimeter and across each of the diameters, but in one direction only. A hunter, “the wolf”, chases the rabbits within the defined area. When the wolf tags a rabbit, that person becomes a wolf as well. The game continues until the last rabbit is tagged. The size of the area can vary according to the age of the participants. The coach may or may not decide to choose to use poles depending on space available to play the game. Refer to section 4.3.9 for an illustration.</p>	<p>10 min.</p>
<p>Herringbone (with poles) (Review)</p>	<p>Coach demonstrates and reviews key points.</p> <p>Red Light, Green Light: The coach is the policeman, and is positioned at the top of the hill. The skiers are positioned at the bottom of the hill, spread out behind the start line, and facing the policeman. When the policeman says “green light” the skiers Herringbone up the hill. When the policeman says “red light” the skiers stop. Once they reach the top of the hill they Free Glide back to the bottom. When caught moving on a red light (going up or down), skiers have to sidestep back to the start line at the bottom of the hill.</p>	<p>10 min.</p>





Double Poling (Review)	<ol style="list-style-type: none">1) Have skiers stand in a stationary position and lean forward at the ankles. As they start to fall forward, have them plant their poles (they should not extend their arms backwards).2) Repeat several times, emphasizing hips over toes when planting poles.3) Double Pole down tracks, emphasizing hips forward.4) Drive arms forward.	10 min.
One-step Double Poling (Introduce)	<ol style="list-style-type: none">1) Coach demonstrates and reviews key points.2) In a stationary position, drive arms forward without planting poles, and extend leg back without pushing forward at the same time.3) Double Pole and recover leg at the same time.4) Repeat several times with one leg, several times with the other leg, and then alternate legs.	10 min.
Game Time	<p>Head to Head Tag: Move to an area where there are several classic tracks set parallel to each other. Divide the group into pairs. Have the skiers lie down on their backs in the middle of the tracks, with their heads together (one metre apart), and legs down the track. Identify one half of each pair of skiers as “bears” and the other half as “dogs.” When the coach yells out “bears,” the bears get up as fast as they can and Diagonal Stride down their end of the track. The dogs get up as fast as they can at the same time and try to tag the bear before the bear reaches the end of the track. The opposite occurs if the “dogs” are called out.</p>	10 min.
Ski Play	Skiers use the ski playground under the supervision of the coaches. Coaches provide some one-on-one instruction.	20 min.
Wrap Up	Conclude the session with hot chocolate and a short social time at the day lodge.	15 min.





PRACTICE PLAN 29 (LEVEL 3 – ON SNOW)

Specific Objectives:

- 1) Develop and improve the skier's balance and agility.
- 2) Develop and improve Free Skate.
- 3) Develop and improve One Skate.
- 4) Develop and improve Kick Turn.
- 5) Prepare for a backwoods adventure.

The skier will require ski equipment for skating technique.

Key Teaching Points:

- Backwoods Adventure.** Refer to the Introduction to Community Coach Reference Material (sections 3.1.6 and 5.5. and section 5.7 of this manual for some additional information. The pre-adventure information session may include handing out maps of the route - including the rendezvous point, what to bring for food and fluids, what ski equipment to use, what to wear, what to bring in your wax kit, etc.

Teaching Aids Needed:

- Cones or other markers.
- Help from parents and other coaches.
- A penny.

Skill	Description	Time
Ski Play (to warm up)	Varied speeds.	5 min.
Balance and Agility	<ol style="list-style-type: none"> 1) Skiers stand in place with skis in a "V" position. 2) Skiers balance on one ski, and touch the other ski with their hand. 3) Next the skiers balance on the other ski and touch the first ski with their hand. 	5 min.





	<ol style="list-style-type: none"> 4) Skiers edge the inside of one ski and then the other. 5) Repeat several times, occasionally edging both skis at the same time. 6) Skiers edge skis and sidestep. 7) Skiers sidestep or hop sideways as far as they can to see who can make the biggest mark in the snow when pushing off. Repeat several times and then reverse direction. 8) Skiers sidestep or hop sideways and slightly forward as far as they can. Emphasize turning the body in the direction of the hop and gliding after the hop. 	
Free Skate (Review)	<ol style="list-style-type: none"> 1) Coach demonstrates Free Skate and reviews key points. 2) Skiers practise the skill. 3) Coach demonstrates bringing foot underneath by clicking skis together. 4) Skiers practise this skill. 5) Emphasize flat ski. <p>Waiter: The coach demonstrates by holding the shaft of a ski pole, shoulder width apart, with elbows “super-glued” to the hips. When the coach glides on a ski, the same side shoulder should be positioned over the glide ski. Emphasize that the poles should be level at all times (a tray with drinks!).</p>	10 min.
Game Time	<p>Cops and Robbers: One coach is the “cop.” The skiers are “robbers.” The robbers are safe as long as they are in a marked area (hideout). However, they cannot stay in the hideout for more than five seconds. One of the marked areas is a prison. When robbers are tagged by a cop, they must go to prison. When captured robbers are tagged by a free robber, they can go free.</p>	10 min.





<p>One Skate (Review)</p>	<ol style="list-style-type: none"> 1) Coach demonstrates the One Skate. 2) Skiers try it, with clicking of heels. 3) Emphasize a flat ski. <p>Double Double Skate: The skiers Double Pole twice on one side before weight shifting to the other side. Repeat. If a skier is proficient and space allows, Double Pole three times, four times, etc.</p>	<p>10 min</p>
<p>Game Time</p>	<p>Penny, Penny, Who's Got the Penny? Divide the skiers into two groups. One skier on one of the teams is given a penny. The other team does not know which opposing member has the penny. The penny carrier has to try and get the penny to his/her team's castle, which is in the opponent's zone. The person who has the penny must show it if tagged. The rest of the team acts as decoys. No poles.</p>	<p>10 min.</p>
<p>Kick Turn (Review)</p>	<ol style="list-style-type: none"> 1) Coach demonstrates the Kick Turn and reviews key points. 2) Skiers practise the skill in both directions. 	<p>5 min.</p>
<p>Game Time</p>	<p>Figure of 8 Relay: Using cones, set up two figure of eight "courses" for the skiers to skate around. Break the group into two teams and use the course for relays. Repeat. Change direction and repeat. When the skiers are competent with this course, challenge them by reducing the size of the loops.</p>	<p>10 min.</p>
<p>Explore a Ski Trail</p>	<p>Skiers explore a designated trail under the supervision of the coaches. The coaches provide some one-on-one instruction.</p>	<p>20 min.</p>
<p>Wrap Up</p>	<p>Conclude the session with hot chocolate and a short social time at the day lodge.</p>	<p>25 min.</p>





PRACTICE PLAN 30 (LEVEL 3 – ON SNOW)

BACKWOODS ADVENTURE

Specific Objectives:

- 1) Introduce children to nature in winter.
- 2) Teach the children how to prepare for a long tour in the woods.
- 3) Practise techniques learned during regular practice sessions.
- 4) Have FUN!

The skier will require equipment for classic technique.

This activity should take place on a ski trail that is new to the skiers and has a “backwoods” feel. However it does not need to be far from the main ski trails to be an adventure.

This is an opportunity for the group to explore and experience nature in winter. Ideally, there will be a cabin somewhere along the route where the group can stop and rest, build a fire and have lunch.

Care should be taken that all skiers arrive at the destination at the same time. Keep the distance achievable and appropriate for the age and skill level of the skiers. For the children, the amount of time on skis should not be more than 1.5 hours in total.

Encourage the children to follow their route on a map.

Things to Bring:

- Equipment repair kit.
- First aid kit
- Compass, maps.
- Food, water.
- Spare clothing and blankets as necessary.
- Matches.
- Extra wax.
- Refer to section 5.2 (Nature and Environment) for additional ideas that may be appropriate for this activity.





PRACTICE PLAN 31 (LEVEL 3 – ON SNOW)

Specific Objectives:

- 1) Develop and improve the skier's balance and agility.
- 2) Review and introduce Diagonal Skate.
- 3) Review and introduce Free Skate.
- 4) Review and introduce Free Glide – High and Low Tuck.
- 5) Develop and improve Herringbone.

The skier will require ski equipment for skating technique.

Key Teaching Points:

❑ Diagonal Skate

- ✓ Maintains “V” shape with skis.
- ✓ Diagonal arm action.
- ✓ Uses inside edges well.
- ✓ Plants pole tips behind, and to the side of feet with handles/hands just below shoulder height.
- ✓ Skis are always moving on snow.
- ✓ Common errors:
 - skis stop before the weight is transferred.
 - arm work is not close to the body.

❑ Free Skate

- ✓ Aligns toes, knees, hips, body, and same side shoulder over gliding ski.
- ✓ Hips and shoulders should face the direction of gliding ski until push is initiated.
- ✓ Consistent glide on left and right ski.
- ✓ Knees and ankles flex before pushing off.
- ✓ During each glide, feet come close to each other.
- ✓ Common errors:
 - upper body turns before push is initiated.
 - upper body only turns to one side.
 - push is off a straight leg.

❑ Free Glide – High and Low Tuck

- ✓ Arms and hands stay well forward of body while gliding down a medium hill.





- ✓ Knees and ankles only slightly bent for the High Tuck.
- ✓ Knees and ankles bent so thighs are parallel to snow in Low Tuck.
- ✓ Upper body is bent down to horizontal position.
- ✓ Poles are held tightly beside the body and under the arms.
- ✓ Skier can safely descend a medium hill with both techniques.
- ✓ Common errors:
 - arms and hands are beside or behind hips.

Teaching Aids Needed:

- Cones or other markers.
- Help from parents and other coaches.
- Trays for half the group; two tennis balls for each tray.

Skill	Description	Time
Ski Play (to warm up)	Varied speeds.	5 min.
Balance and Agility	<p>Quick Thinking: This game tests the skiers' ability to move quickly and maintain balance. The coach stands in front of the group and points in different directions (forward, backward, side-ways). The group responds accordingly. In addition to pointing directions, the coach can call out directions as well. If two skiers collide, they are eliminated from the game. Another variation is to arrange the skiers in a large circle. The coach then calls out "hop left," "slide right," "jump left," etc. No poles.</p>	5 min.
Diagonal Skate (Review)	<ol style="list-style-type: none"> 1) The coach demonstrates and reviews key points. 2) Skiers Herringbone up a hill, with the hump beneath their body. 3) Repeat, with skis "sliding down the hump," but uphill. 4) Repeat, but have them sliding their skis as far as possible. 	10 min.





	<p>5) Repeat, but emphasize the transfer of weight off the ski before it stops.</p> <p>6) Repeat, but with emphasis on diagonal arm work.</p>	
Game Time	<p>Touch Your Knees: Skiers skate, and when they are gliding on their left ski they touch their right hand to their left knee and vice versa. This exercise will encourage a good length of glide on each ski.</p> <p>Speedskating: Have the skiers skate faster, crouching down and moving their hands well out in front so they almost reach out and over the opposite ski tip.</p>	10 min.
Free Skate (Review)	<p>1) Coach demonstrates the Free Skate and reviews the key points.</p> <p>Waiter: The coach demonstrates by holding the shaft of a ski pole, shoulder width apart, with elbows “super-glued” to the hips. When the coach glides on a ski, the same side shoulder should be positioned over the glide ski. Emphasize that the poles should be level at all times (a tray with drinks!).</p> <p>2) Emphasize aligning knee and hips/shoulder over the gliding ski.</p> <p>3) Skiers use the poles by their handles, but do not plant their poles.</p> <p>4) Emphasize body alignment over each gliding ski.</p>	10 min.
Game Time	<p>Waiter Race: Each skier or team is given a serving tray with two tennis balls or rubber balls. The skiers must ski a short course, holding the tray in front of them, without losing the balls. If skiers lose their ball they must stop and retrieve it. The course should contain turns to both the left and right.</p>	10 min.





Herringbone (Review)	<ol style="list-style-type: none">1) Coach demonstrates and reviews key points.2) Skiers practise it.3) Emphasize keeping the arm work close to the body.	5 min.
Free Glide – High and Low Tuck (Review and introduce)	<ol style="list-style-type: none">1) Coach demonstrates and reviews key points while standing on a flat area.2) Skiers stand in a stationary position and practise both the High and Low Tuck. <p>Streamers: Place two different coloured streamers or surveyors' tapes above the tracks. The streamers should be at a height that would just touch the back of a skier in a High Tuck. Skiers go down the hill in a Low Tuck staying below the streamers. Then they ski down the hill in a High Tuck, touching the streamers with their back, but not their head. The next step is for the skiers to do one colour in a High Tuck and the other in a Low Tuck. The streamers must be set up in such a way that they do not pose any danger to the skiers.</p>	10 min.
Game Time	<p>Follow the Leader: Skiers follow the Leader and copy the technique used. Change Leaders every minute by having the Leader skier move to the side and get in line at the back.</p>	10 min.
Ski Play	Skiers use the ski playground under the supervision of the coaches. Coaches provide some one-on-one instruction.	20 min.
Wrap Up	Conclude the session with hot chocolate and a short social time at the day lodge.	15 min.





PRACTICE PLAN 32 (LEVEL 3 – ON SNOW)

MODIFIED SKI TOURNAMENT

Participation in a modified ski tournament or other team-building, semi-competitive activity such as an inter-school tournament or a mini-Olympics will introduce your group to new activities on skis. If you are fortunate, your club will organize special activities periodically, and all you will be responsible for is bringing your group. If not, refer to section 5.5 of the Introduction to Community Coaching Reference Material or section 8.3 of this manual and create a “special activity” of your own. This could be a Beckie Scott Day, Rabbit Fun Day (refer to section 5.5) or a similar activity.

Specific Objectives:

- 1) Introduce skiers to a new type of cross-country ski experience.
- 2) Practise skills learned during regular practice sessions.
- 3) Have FUN!

Key Teaching Points:

- Plan for the activity and, if necessary, prepare the setting ahead of time.
- Provide suitable coaching support for the activity that has been selected.
- No formal ski instruction.
- Use opportunities for one-on-one technique instruction.

Teaching Aids Needed:

- Extra help from parents and other coaches.
- Depends on the activity.





PRACTICE PLAN 33 (LEVEL 3 – ON SNOW)

Specific Objectives:

- 1) Develop and improve the skier's balance and agility.
- 2) Review Diagonal Stride.
- 3) Review and introduce Step Turn.
- 4) Review and introduce Double Poling.
- 5) Review and introduce One-step Double Poling.
- 6) Introduce Skate Turn.

The skier will require ski equipment for classic technique.

Key Teaching Points:

❑ Step Turn

- ✓ Glides down small, untracked hill in the Ready Position.
- ✓ Demonstrates weight transfer while stepping.
- ✓ Edges skis while stepping.
- ✓ Skier can step 3-5 steps in one direction.
- ✓ Skier can link step turns in either direction together.
- ✓ Consistently keeps poles in the Ready Position.
- ✓ Takes quick small steps.
- ✓ Common errors:
 - doesn't keep arms in Ready Position.
 - body position gets stuck between steps.
 - ski sideslips when stepping off – ski not edged.

❑ Double Poling

- ✓ Skier's hands reach forward when planting poles.
- ✓ Elbows are slightly bent at pole plant.
- ✓ Pole tips don't come ahead of pole handles.
- ✓ Skier leans forward at pole plant, hips are just above or ahead of toes.
- ✓ Upper body flexes forward just after poles are planted.
- ✓ After body bends forward, arms follow through (upper body, then shoulders, then elbows).
- ✓ Legs remain relatively straight throughout the sequence.
- ✓ Skier is able to push down the track Double Poling.





- ✓ Common errors:
 - skier uses arms only, doesn't use upper body (trunk).
 - skier sits back during poling, bends knees.
 - straight arm plant.
 - pole tips swing forward of pole hands.

One-step Double Poling

- ✓ Emphasize the trunk movement when poling.
- ✓ Emphasize that timing of the upper trunk movements are: trunk, shoulders, elbows and wrists.
- ✓ Common errors:
 - improper timing.
 - little or no weight shift from the push foot to the gliding ski.

Skate Turn

- ✓ Skier performs Double Poling just in front of the location he/she wishes to turn.
- ✓ Skier recovers arms and upper body forward,
- ✓ The inside ski (the ski that is on the side to which the skier is turning) is unweighted and pointed in the new direction.
- ✓ Skier edges and pushes off the outside ski transferring the body weight to the inside ski.
- ✓ Skier then glides with the skis parallel and equally weighted in the new direction.
- ✓ Another Double Poling action completes the turn.

Teaching Aids Needed:

- Sufficient sets of parallel tracks to play Scooter games.
- Cones or other markers.
- Help from parents and other coaches.
- Measuring tape.

Skill	Description	Time
Ski Play (to warm up)	Varied speeds.	5 min.
Balance and Agility	1) Have skiers step left or right on command from coach.	5 min.





	<p>2) Slow and fast.</p> <p>Scooter Freeze: Skiers remove one ski. They give three pushes with their foot and then “freeze” on the glide leg with the kick foot leg extended back. Skiers should remain in this position until the ski comes to a stop. The objective is to see how far the skiers can glide. Arms should be in a diagonal position, and not out to the side. Repeat and alternate skis.</p>	
<p>Diagonal Stride (Review)</p>	<p>1) Coach demonstrates and reviews the appropriate key points.</p> <p>Measured Scooter: Mark off one track every 0.5 metres. Mark other tracks at 0.75 metre, 1 metre and 1.25 metre intervals. Have the skiers start in the first track. If they continually glide past each marker, then move to the next track, etc.</p> <p>2) Repeat using Diagonal Stride with poles.</p> <p>3) Emphasize recovery foot beside or in front.</p> <p>4) Emphasize forward lean.</p>	<p>10 min.</p>
<p>Step Turn (Review)</p>	<p>1) Coach demonstrates on an untracked hill, and reviews key points.</p> <p>2) Skiers start off Free Gliding on an untracked hill (or outside the tracks on a tracked hill).</p> <p>3) Repeat but Step Turn at the bottom of the hill. Leave marks on the snow (edging) when stepping.</p> <p>4) Emphasize weight shift and quick steps.</p> <p>5) Repeat, but Step Turn in the middle of the hill. Leave marks on the snow (edging, not skidding), when stepping.</p> <p>6) Emphasize weight transfer and quick steps.</p> <p>7) Skiers practise turning both ways.</p> <p>8) Skiers practise linking Step Turns together.</p>	<p>10 min.</p>





<p>Game Time</p>	<p>Follow the Leader: The skiers follow the coach who leads them through the ski playground, changing directions frequently, going over and around obstacles and using different terrain. The objective is to incorporate the Step Turn as much as possible.</p>	<p>10 min.</p>
<p>Double Poling (Review)</p>	<p>Coach demonstrates and reviews key points.</p>	<p>5 min.</p>
<p>One-step Double Poling (Introduce)</p>	<ol style="list-style-type: none"> 1) The coach or role model demonstrates and reviews the key points. 2) Skiers stand in stationary position, drive arms forward without planting poles, and extend leg back without pushing forward at the same time. Double Pole and recover leg at the same time. Double Pole and recover leg, several times with the other leg, and then alternate legs. <p>Double Pole Scooter: Similar to the Diagonal Scooter, but both arms drive forward at the same time. Emphasize weight shift and planting free foot forward.</p> <ol style="list-style-type: none"> 3) Try this exercise using One-step Double Poling. 4) Emphasize trunk action in poling. Emphasize using the joints in order – trunk, shoulders, elbows, wrists. 	<p>10 min.</p>





Game Time	Loose Caboose: Mark out a large circle in the snow. Appoint one skier as the “switcher” and then break the rest of the skiers up into groups of three to five. Each group is a “train.” Each train consists of an engine, one to three cars and a caboose. You can have as many trains as you have skiers and space to work with. The engines try to steer their train away from the switcher. The switcher tries to tag a caboose. If a caboose is tagged, the skier becomes another switcher, and the last skier in the train becomes the new caboose for that train. New switchers cannot tag the train they came from. The winner is the last train or engine left. No poles.	10 min.
Skate Turn (Introduce)	<ol style="list-style-type: none">1) Coach or role model demonstrates and reviews the key points.2) Have skiers practise on a short loop that has several skate turn corners included.3) Change direction and repeat.	10 min.
Explore a Ski Trail	Skiers explore a designated trail under the supervision of the coaches. The coaches provide some one-on-one instruction.	20 min.
Wrap Up	Conclude the session with hot chocolate and a short social time at the day lodge.	15 min.





PRACTICE PLAN 34 (LEVEL 3 – ON SNOW)

Specific Objectives:

- 1) Develop and improve the skier's balance and agility.
- 2) Develop and improve Free Skate.
- 3) Develop and improve Diagonal Skate.
- 4) Review and introduce One Skate.
- 5) Review and introduce Free Glide – High and Low Tuck.

The skier will require ski equipment for skating technique.

Key Teaching Points:

One Skate

- ✓ Align toes, knees, hips, body and same side shoulder over glide ski.
- ✓ Hips should face the direction of gliding ski until push is initiated.
- ✓ Consistent glide on left and right ski.
- ✓ Knees and ankles flex before pushing off.
- ✓ During each glide, feet come close to each other.
- ✓ Upper body bends while poling.
- ✓ Common errors:
 - incomplete weight transfer on one side or both sides.
 - pushes off straight leg.
 - poles using arms only.
 - upper body moves before leg push is initiated.
 - Double Poles down the middle of the trail.

Free Glide – High and Low Tuck

- ✓ Arms and hands stay well forward of body while gliding down a medium hill (8 to 10 metre glide).
- ✓ Knees and ankles should be only bent slightly for the High Tuck.
- ✓ Knees and ankles bent so that the thighs are parallel to snow in a Low Tuck.
- ✓ Upper body is bent down to horizontal position.
- ✓ Poles are held tightly beside the body and under the arms.



**Teaching Aids Needed:**

- ❑ Shovel to build hump in middle of hill. The hump should be designed to go up the length of the hill. This should be done a day in advance to ensure the snow sets up properly. If the skiers progress well in the first Diagonal Skate session, the height of the hump can be reduced. For the next Diagonal Skate session, the skiers should progress to using a hill without a hump.
- ❑ Coloured ropes approximately 30 centimetres in length (10 or more).

Skill	Description	Time
Ski Play (to warm up)	Varied speeds.	5 min.
Balance and Agility	<ol style="list-style-type: none"> 1) Skiers stand in place with skis in a “V” position. 2) Skiers balance on one ski, and touch the other ski with their hand. 3) Next skiers balance on the other ski and touch the first ski with their hand. 4) Skiers edge the inside of one ski and then the other. 5) Repeat several times, occasionally edging both skis at the same time. 6) Skiers edge skis and sidestep. 7) Skiers sidestep or hop sideways as far as they can to see who can make the biggest mark in the snow when pushing off. Repeat several times and then reverse direction. 8) Skiers sidestep or hop sideways and slightly forward as far as they can. Emphasize turning the body in the direction of the hop and gliding after the hop. 	5 min.





<p>Free Skate (Review)</p>	<ol style="list-style-type: none"> 1) Coach demonstrates Free Skate and reviews key points. 2) Skiers practise the skill. <p>Waiter: The coach demonstrates by holding the shaft of a ski pole, shoulder width apart, with elbows “super-glued” to the hips. When the coach glides on a ski, the same side shoulder should be positioned over the glide ski. Emphasize that the poles should be level at all times (a tray with drinks!). This drill only works if skiers can keep their elbows on their hips.</p> <ol style="list-style-type: none"> 3) Emphasize aligning knee and hips/shoulder over the gliding ski. 4) Skiers do a single skate and glide to a stop. Repeat with the other foot. Emphasize knee and ankle flexion before kicking. Emphasize facing in the direction of the ski glide until they stop 5) Skiers use the poles by their handles, but do not plant their poles. Emphasize body alignment over each gliding ski. 	<p>10 min.</p>
<p>Game Time</p>	<p>British Bulldog: The Bulldog is positioned in the middle of a flat open area, with the rest of the skiers behind a line at one end. At a command from the coach, the skiers try and cross to the line at the other side of the area without being tagged. If tagged, a skier becomes another Bulldog and helps the first Bulldog to tag skiers.</p>	<p>10 min.</p>
<p>Diagonal Skate (Review)</p>	<ol style="list-style-type: none"> 1) Coach demonstrates and reviews key points. 2) Skiers Herringbone up a hill with the hump staying beneath their body. 3) Repeat with skis “sliding down hump,” but uphill. 4) Repeat, emphasizing weight shifting off the ski before it stops. 5) Emphasize stepping up hill. 	<p>5 min.</p>





Game Time	Diagonal Slide: Place the coloured ropes on the hill, interspersed so skiers have to step over them. Angle the ropes so they will be parallel to where the skis will be when the skiers are Diagonal Skating. The objective is to see how far apart the ropes can go with the skier still sliding their skis.	10 min.
One Skate (Review and introduce)	<ol style="list-style-type: none">1) Coach demonstrates and reviews key points.2) Skiers practise One Skate with an emphasis on aligning the knee, hip and same side shoulder over the gliding ski. Double Double Skate: Skiers Double Pole twice on each side. During the initiation of the second poling, the skate and weight transfer to the other ski takes place.	10 min.
Free Glide – High and Low Tuck (Introduce)	<ol style="list-style-type: none">1) Coach or role model demonstrates and reviews key points.2) Skiers practise Free Glide with an emphasis on hands forward and knees bent.3) Begin with a High Tuck, then a Low Tuck, then switching from one to the other on the same hill.4) Add a Step Turn.	10 min.
Game Time	Duck, Duck, Goose: Form a circle ten metres in diameter, with the skiers facing towards the centre. One skier is on the outside of the circle, skiing behind the group and saying “Duck, Duck, Duck” as he/she touches each of the other skiers on the back. When he/she touches a skier and says “Goose,” that skier must leave his/her place. Both skiers race around the circle to see who can be the first to get to the vacant position. The first one to get there wins. The unsuccessful skier then circles behind the group saying “Duck, Duck” etc. Variation for larger groups - two skiers skiing outside the circle, going in opposite directions. The coach may or may not choose to use poles.	10 min.





Ski Play	Skiers use the ski playground under the supervision of the coaches. Coaches provide some one-on-one instruction.	20 min.
Wrap Up	Conclude the session with hot chocolate, the treasure findings and a short social time at the day lodge.	15 min.





PRACTICE PLAN 35 (LEVEL 3 – ON SNOW)

ORIENTEERING POKER SKI

An Orienteering Poker Ski is an adventure-based activity that encourages children to spend a FUN afternoon on skis learning more about wildlife in the area where they ski.

Specific Objectives:

- 1) Introduce the skier to a new type of cross-country ski experience.
- 2) Teach the skier about the animals that he/she shares the forest with during the winter season.
- 3) Practise skills learned during regular practice sessions.
- 4) Have FUN!

Instructions:

- Plan the activity and set up the orienteering route ahead of time.
- Skiers gather at the start area (“S” on the map)
- Each skier is given a participant package.
- Ensure that each skier has a partner or an adult to ski with them before they begin the orienteering route.

Teaching Aids Needed:

- Refer to section 5.2 (Nature and Environment – Animal Tracks) for more information.
- Participant package for each child taking part in the activity:
 - ✓ A whistle (for safety).
 - ✓ A compass.
 - ✓ Instructions on how to use the compass (instruction sheet provided below).
 - ✓ A small (5” x 8”) photocopy of an aerial map of the ski area indicating the trail system, the start/finish point, and each station en route (sample map: Figure 5.5, on the following page).
 - ✓ Instructions on how to play the game (Figure 5.6)
 - ✓ Two pencils or markers that will work on waterproofed paper.
 - ✓ A “picture key” of animal tracks (sample picture key: Figure 5.7). Refer to section 5.7 Animal Tracks for more information.
 - ✓ Orienteering control points sheet (Figure 5.8).





- ✓ A plastic zip lock bag to hold the above items.
- ✓ Note: all paper should be waterproofed.
- ❑ Blue flagging tape; five bags and five decks of cards.
- ❑ Ten laminated pictures of animal tracks on a white background (one for each animal).
- ❑ Prizes for the participants that complete the orienteering course; prizes for the Orienteering Poker Ski winners.

Instructions on How to Use a Compass:

- ❑ To find a bearing to control points using a map and an orienteering compass, follow the steps below:
 1. Place the compass on the map with the long edge of the compass joining your start and destination (control) points. Make sure the compass is oriented with the mirror end toward the destination point.
 2. Turn the compass dial until the orienting lines are parallel to the true north meridian lines on the map. Check that “N” on the compass dial is toward map north. Your bearing is the number on the compass dial that lines up with the direction of travel line at the mirror end of the compass.
 3. Take the compass off the map and hold it out in front of you with the line through the mirror pointing straight ahead of you. Do not turn the compass dial. While holding the compass in front of you, rotate your body until the compass needle lines up over the magnetic north arrow on the compass dial. You are now facing in the direction of the desired compass bearing. Start walking (or skiing)!!!
 4. To make sure you keep on course you can fold the mirror back and sight through the small “V” on top of the mirror while using the mirror to make sure the needle is lined up with the magnetic north arrow. Sight on an object (i.e. tree) several metres ahead. Walk to that point and take another sighting. Continue until you travel the desired distance (keeping track of your paces) and you reach your desired destination. Remember that due to small mapping and orienteering inaccuracies your route will not be exact. Use your observation skills to find the control point. For this exercise, the control points are marked with blue flagging tap at the base of trees or shrubs – the control point number is written in felt pen on the flagging. Ignore all other coloured flagging in the bush.



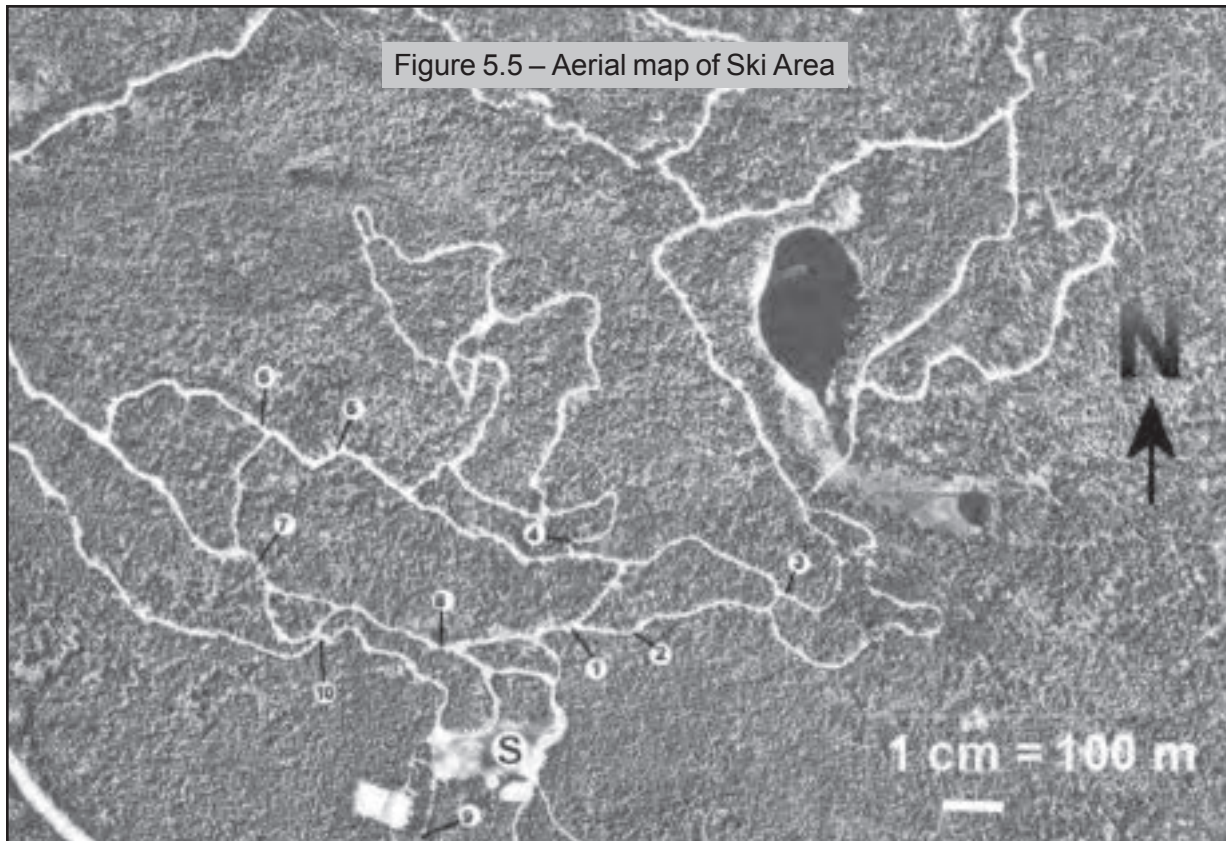

Orienteering Poker Ski Instructions – Here's What You Do!

- 1) Study the map and note the location of the ten control points (white circles with numbers).
- 2) Starting at the big "S," ski the route, and using your map, locate control point #1. Note that the control points are located 10 - 15 metres off the trail (into the woods) as indicated on the map. When you arrive at a control point you will see some blue flagging hanging from a tree and a picture of an animal track on a white card.
- 3) Using the picture key provided, identify the animal track and write down the name of the animal where it says "Control Point #1" on your sheet.
- 4) Continue on and do the same at each of the ten control points. When you complete the orienteering route you will receive a small prize.
- 5) **Poker Ski** – as you ski along the trail you will come across five Poker Dealers, each with a bag of cards. From each dealer, pick a card from the bag and write down the card value and suit on your sheet. Give the card back to the Dealer, and continue on your ski. At the end of the ski you will have collected a five-card poker hand. If you have one of the three highest scoring poker hands you will win an additional prize (provided you have correctly identified all the animals at the ten orienteering control points)!!!
- 6) Eat your prize!!!

Safety Tips:

- Ski together in teams to reduce the possibility of getting lost. If you are under 12, you should do the route with an adult.
- One skier may choose to go into the woods to find the control point, while the other chooses to remain on the main ski trail. Stay in communication. If you go into the woods, follow your own ski tracks back to the main trail.
- Whistles are provided with each participant package. Use the whistle ONLY if you are lost.

Figure 5.6



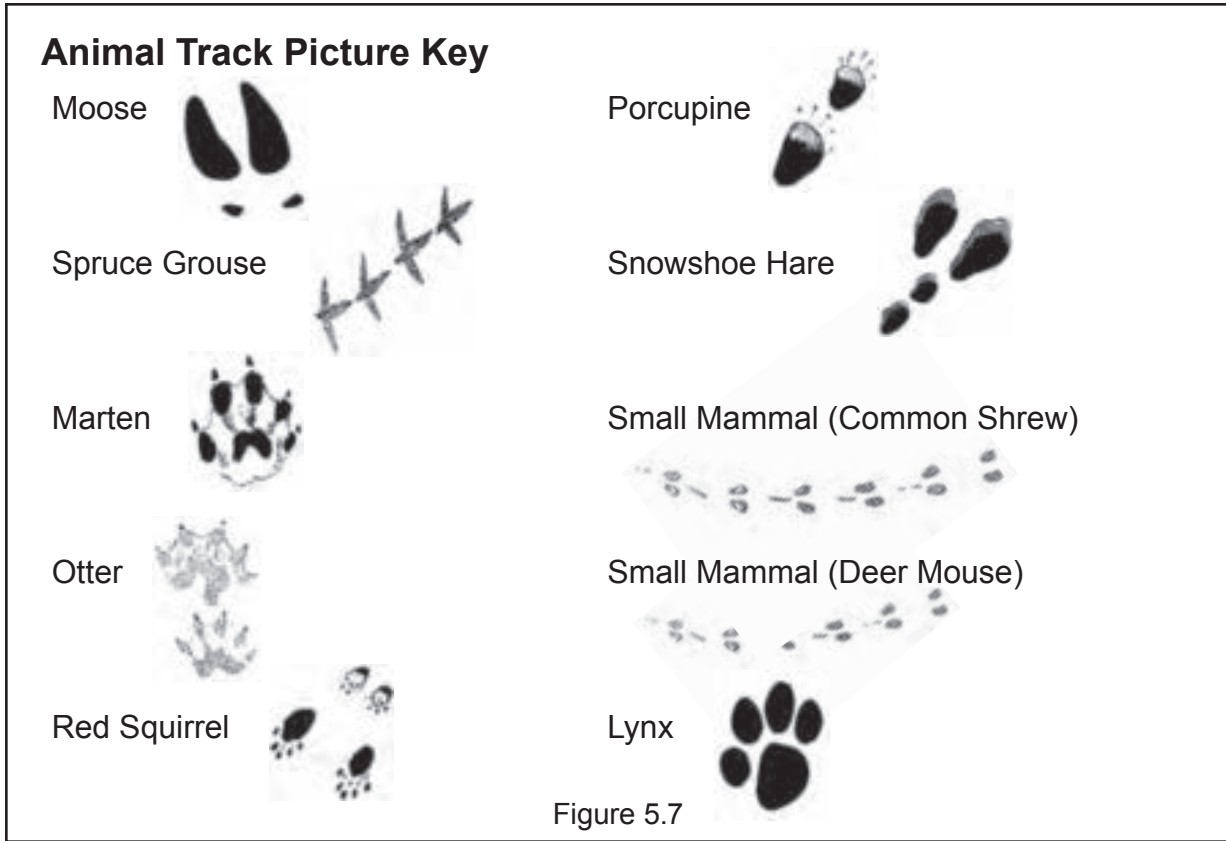

Orienteering Control Points

1) Name the animal at each control point marked on the map.
 2) Control points #1 to #10 have pictures of animal tracks, and are also marked by blue flagging tape hanging from a tree. Use the "picture key" on the other side of this paper to properly identify the track.

Control Point #1
Control Point #2
Control Point #3
Control Point #4
Control Point #5
Control Point #6
Control Point #7
Control Point #8
Control Point #9
Control Point #10
Poker Card Hand
1
2
3
4
5





PRACTICE PLAN 36 (LEVEL 3 – ON SNOW)

DOWNHILL GAMES

Specific Objectives:

- 1) Develop and improve the skier's balance and agility on downhills.
- 2) Provide the skier with an opportunity to focus on downhill technique skills.

Note: Skiers should use skating equipment, or classic skis waxed for skating (glide wax tip to tail) with skating poles.

Key Teaching Points:

- Select a hill that has a suitable gradient for the skill level of the group. Arrange grooming for a large enough area that all of the group can be active at the same time.
- Use the opportunity for one-on-one technique instruction.

Teaching Aids Needed:

- Coloured sticks.
- Cones or other markers.
- Help from parents and other coaches.
- Tall poles and coloured ribbon or tape.

Skill	Description	Time
Ski Play (to warm up)	Varied speeds.	5 min.
Downhill Games	<p>Pick-up Sticks: Skiers start at bottom of a hill. They ski up the hill using the technique of choice, and then Free Glide down the hill. Parallel to the tracks going down the hill there are sticks lying flat on the snow. As the skiers come down the hill they try to pick up three sticks. Repeat.</p> <p>Roller Coaster Bumps: Add one or two bumps on the downhill for the skiers to go over or jump off of. Begin initially with picking up one stick on the run down, increase that number to two sticks, and three sticks if the skiers can manage it.</p>	70 min





	<p>Reach and Tuck: Use crossed ski poles to set up a series of archways on a long gentle slope (two poles per archway). Set up an archway every five or six metres. Place a single pole angled into the snow, between the arches and tie a ribbon to the top of it. To play the game, the skiers bend down when going under the arch, and reach up to touch the ribbon on the pole between the arches. Increase the challenge, allow the skiers to increase their speed, or shorten the distance between the poles.</p>  <p>Figure 5.9</p> <p>Human Slalom: Have the skiers break into small groups of three or four. Each group moves to a different location, and stands several metres apart, in a line, going down a long hill. The skiers at the top slalom down the hill, moving around the other skiers in their group. They stop a few metres after the final skier in the line. The next skiers at the top of the hill slalom then through the line of skiers and stop a few metres beyond the final skier in the line. This continues until all the skiers are at the bottom of the hill.</p>	
<p>Ski Play</p>	<p>Skiers use the ski playground under the supervision of the coaches. Coaches provide one-on-one instruction.</p>	<p>20 min.</p>
<p>Wrap Up (in day lodge)</p>	<p>Conclude the session with hot chocolate, snacks and a short social time at the day lodge.</p>	<p>15 min.</p>



PRACTICE PLAN 37 (LEVEL 3 – ON SNOW)

SPRINT GAMES

Specific Objectives:

- 1) Introduce skiers to a speed “game” using skating technique.
- 2) Have FUN!
- 3) Determine annual Program Awards for Sprints.

Skating technique is recommended for the Level 3 Sprint Games.

Refer to Practice Plan 11 – Level 2 for detailed information. Note some exceptions to Plan 11 are listed below.

Tasks:

- Arrange ahead of time for a section of flat terrain, 100 (+) metres in length, to be packed and marked into four lanes. Each lane should be wide enough for a skier to use skating technique. The course should be set in a straight line, with no corners. The markers can be made with small branches, water-soluble paint or some similar material.
- This activity may be held in conjunction with sprint games for other age groups. Some of these groups may use classic technique, in which case two separate “courses” will be required.
- Explain the “rules” of this game (e.g. skiers can use skating technique only; they cannot change lanes, etc.)

If time permits, finish off the session with Follow the Leader, with one of the coaches leading the group on one of the ski trails for approximately 20 minutes.





PRACTICE PLAN 38 (LEVEL 3 – ON SNOW)

SKILL EVALUATION SESSION – CLASSIC AND SKATING TECHNIQUES

Specific Objectives:

- 1) Review and evaluate each skier's skills against the Level 3 standard for both classic and skating techniques.
- 2) Conduct the assessment in an informal environment so that the skiers are not intimidated.

Key Teaching Points:

- Divide the session into two sequential components, with each component dedicated to a different technique. One of these components could be held at the ski playground or a similar location, and the other on a ski trail with suitable terrain variation.
- Prepare the setting ahead of time, as with Practice Plan 14 - Level 2.
- When evaluating skiers, the emphasis should be on the successful accomplishment of a skill. The standard should be achieved only if it is truly deserved.

Teaching Aids Needed:

- Extra help from parents or other coaches.
- Clipboards and paper with plastic protection; pencils.
- "Skill Criteria and Evaluation Benchmarks - Level 3" and "Skill Checklist - Level 3" from your Reference Material (sections 4.3.5 and 4.3.6).
- The Skill Checklist should be prepared ahead of time for finishing off the evaluations.
- Ski playground area and trail set up appropriately for the age and skill level of the skiers; groomed for both classic and skating technique.
- Various pieces of equipment and signs to prepare the trail and ski playground.

Skill	Description	Time
Ski Play (to warm up)	Varied speeds.	5 min.





Assess all Level 3 Skills	<ol style="list-style-type: none">1) Begin with the selected technique, either skating or classic, and the selected setting.2) Coaches evaluate the skiers' skills and record their evaluation on the Skills Checklist.3) Alternate technique and setting. Coaches assist skiers to make the changeover in equipment.4) Coaches evaluate the skiers' skills and record their evaluation on the Skills Checklist.	30 min. 10 min. 30 min.
Explore a Ski Trail	Skiers explore a designated trail under the supervision of the coaches. The coaches provide some one-on-one instruction.	20 min.
Wrap Up (in day lodge)	Remind the group to come prepared for both skating and classic technique at the next practice session. Conclude the session with hot chocolate, snacks and a short social time at the day lodge.	15 min.





PRACTICE PLAN 39 (LEVEL 3 – ON SNOW)

Specific Objectives:

- 1) Work with individual skiers to improve skills (classic and skating) that are below Level 3 standard.
- 2) Continue to evaluate skiers for year-end skill awards.

Teaching Aids Needed:

- Appropriate video/DVD to show the skiers what they can achieve if they continue to improve their ski skills, and to inspire them to work towards this goal.
- Ski playground area set up appropriately to meet evaluation requirements.

Skill	Description	Time
Review Technique Skills	Video presentation in day lodge.	20 min.
	The coaches identify which technique each skier will practise initially during the on-snow session, and, if necessary, help them to prepare their ski equipment.	10 min.
Ski Play and Work on Skills	<ol style="list-style-type: none"> 1) Skiers use ski playground under the supervision of the coaches. 2) Coach demonstrates and goes over key points (with individual skiers) of skills that have been identified as requiring improvement. One-on-one basis. 3) Skiers that require practice/re-evaluation for both techniques change their equipment, or prepare their skis for a different technique with the help of their coaches. 4) Continue with demonstrations and practice on a one-on-one basis. 	45 min.
Wrap Up (in day lodge)	Conclude the session with hot chocolate, snacks and a short social time at the day lodge.	15 min.





PRACTICE PLAN 40 (LEVEL 3 – ON SNOW)

YEAR END ACTIVITY

Specific Objectives:

- 1) To provide a fun finale to the season's activities.
- 2) To encourage team work through adventurous cooperative activities.
- 3) To further develop the skier's cross-country ski skills.
- 4) To recognize enthusiasm effort skill achievement and respect for others.

Teaching Aids Needed:

- Technique and Program Awards, Progress Reports.
- This depends entirely on the activities that are used.
- Refer to sections 4.3 and 5.5 of the Introduction to Community Coaching Reference Material, and sections 4.3.9 and 8.3 of this manual for a selection of suitable activities.





5.6 Practice Plans: FUNdamentals Stage of Development - Level 4

Points to keep in mind in addition to those listed in sections 5.2, 5.3, and 5.4.

Practice sessions should begin in October. Refer to section 5.1.2 for more information, including samples of age appropriate pre-ski season practice sessions.

The first twelve practice plans for Level 4 should be for pre-ski season practice sessions. This section provides practice plans for on snow sessions only.

Wrap up the initial session with a short talk explaining the Program Awards and other administrative or logistical program details. Coaches meet parents. The following practice plans are for the on-snow sessions only.





PRACTICE PLAN 13 (LEVEL 4 – INDOORS)

SKI PREPARATION SESSION

Specific Objectives:

- 1) Teach the skier that good ski-care habits and appropriate ski preparation will result in positive ski experiences.
- 2) Introduce the “Ideal Tool Box for a Community Coach.”
- 3) Review and introduce base preparation and grip wax application.
- 4) Introduce the basic steps for applying klister.

Note: Advise skiers to bring their classic and skating equipment (if they have skating equipment) to this session.

Key Teaching Points:

Coach’s Tool Box

- ✓ Explain the purpose of each tool; demonstrate how the more relevant tools for this age group are used.

Base Preparation and Application of Grip Wax

- ✓ Review what was covered the previous year (Practice Plan 11, Level 3..
- ✓ Increase the level of information on base preparation and the application of grip wax.
- ✓ Increase the skier’s level of responsibility when preparing own skis.
- ✓ Review how a classic ski is prepared for skating technique.

Application of Klister

- ✓ Have the skier clean the grip wax pocket of one ski with wax remover.
- ✓ Warm the klister tube (use warm water in a can, or a hand).
- ✓ Poke a small hole in the top of the tube.
- ✓ Squeeze short, thin strips on both sides of the groove, in a uniform manner, in the grip zone of the ski.
- ✓ Ensure the strips are horizontal, from the groove out, rather than running the length of the ski.
- ✓ Spread it evenly using a thumb, a klister brush or the klister spreader that comes in the box.
- ✓ If the layer looks too thin, add some more.
- ✓ When the klister application is finished, allow the ski cool for at least 10-15 minutes.





- ✓ Skiers examines the ski.

Teaching Aids Needed:

- A suitable room to hold a ski preparation session.
- Set tracks close to the room so that the skiers can test their skis (if held during the winter season)
- An appropriate number of coaches/parents to provide close supervision.
- A coach's tool box for demonstration purposes (refer to section 7.2 for details).
- Enough ski forms and a supply of tools for the skiers to use.
- Refer to section 3.5 of the Introduction to Community Coaching Reference Material or section 7 of this manual for additional information.

Ensure adequate supervision for all ski preparation sessions!

Conclude the session with hot chocolate, snacks and a short video.



**PRACTICE PLAN 14 (LEVEL 4 – ON SNOW)****Specific Objectives:**

- 1) Have FUN!
- 2) Develop and improve the skier's balance and agility.
- 3) Assess Level 3 classic technique skills to ensure skiers are in the appropriate group (Diagonal Stride, Double Poling, One-step Double Poling, Snowplow Turn, Kick Turn and Free Glide with Low and High Tuck).
- 4) Assess ski equipment to determine if appropriate for Level 4 skill development. Provide feedback to parents if equipment is inadequate.
- 5) Review Diagonal Stride and Snowplow Turn.

Note: Skiers will require ski equipment for classic technique.

Teaching Aids Needed:

- Tracks are set for classic technique.
- Sufficient parallel tracks for Scooter games.
- Ski playground set up for the age and skill level of the skiers.
- Help from parents and other coaches.
- Name tags (masking tape and marker) to identify the skiers.

Skill	Description	Time
Ski Play (to warm up)	Varied speeds.	5 min.
Balance and Agility	<ol style="list-style-type: none"> 1) Have skiers step left or right on command from coach. 2) Slow and fast. <p>Scooter Freeze: Skiers remove one ski. They give three pushes with their foot and then “freeze” on the glide leg with the kick foot leg extended back. The skiers should remain in this position until the ski comes to a stop. The objective is to see how far the skiers can glide. Arms should be in a diagonal position, and not out to the side. Repeat and alternate skis.</p>	5 min.





<p>Assess Level 3 Skills (classic technique)</p>	<p>Follow the Leader: The skiers follow one of the coaches who leads them through a number of techniques as they move through the ski playground.</p> <ol style="list-style-type: none"> 1) Have skiers Diagonal Stride – Long Step. 2) Have skiers Double Pole. 3) Have skiers Herringbone up a small hill. 4) Have skiers Free Glide back down the hill. 5) Have skiers Herringbone up a long slope, medium gradient. 6) Have skiers Snowplow Stop, Half-snowplow Brake and Snowplow Turn coming down the hill. 7) Have skiers Skate Turn on the flat. During this exercise the skiers are assessed by the coach. 	<p>20 min.</p>
<p>Diagonal Stride (with poles) (Review)</p>	<ol style="list-style-type: none"> 1) Coach demonstrates and reviews the appropriate key points. Measured Scooter: Mark off one track every 0.5 metres. Mark other tracks at 0.75 metre, 1 metre and 1.25 metre intervals. Have the skiers start in the first track. If they continually glide past each marker, they move to the next track, etc. 2) Repeat using Diagonal Stride with poles. 3) Emphasize recovery foot beside or in front. 4) Emphasize forward lean. 	<p>10 min.</p>
<p>Snowplow Turn (Review)</p>	<p>Coach demonstrates and reviews key points. Refer to Practice Plan 12 – Level 2 and section 4.3.3 for detailed information.</p>	<p>5 min.</p>
<p>Game Time</p>	<p>Snowplow with Poles: The coach sets up a slalom course on the hill as per the diagram. Poles are staggered three/four metres apart. The distance between two poles on the same side would be about five metres. Skiers ski down the hill to the inside of each pole and reach out and try to touch the pole as they go by.</p>	<p>15 min.</p>



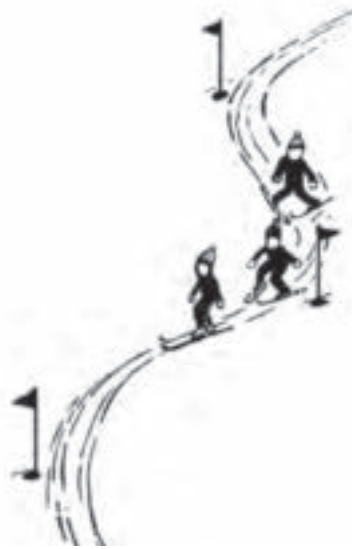

Figure 5.10

Game Time	<p>Loose Caboose: Mark out a large circle in the snow. Appoint one skier as the “switcher” and then break the rest of the skiers up into groups of three to five. Each group is a “train.” Each train consists of an engine, one to three cars and a caboose. You can have as many trains as you have skiers and space to work with. The engines try to steer their train away from the switcher. The switcher tries to tag a caboose. If a caboose is tagged, the skier becomes another switcher, and the last skier in the train becomes the new caboose for that train. New switchers cannot tag the train they came from. The winner is the last train or engine left. No poles.</p>	15 min.
Ski Play	Skiers use the ski playground under the supervision of the coaches. Coaches provide one-on-one instruction.	20 min.
Wrap Up (in day lodge)	The coach should wrap up the session, talking to the children, reminding them about the snow goal awards and other administrative or logistical details. Meet the parents and conclude the session with hot chocolate, snacks and a short social time.	15 min.





PRACTICE PLAN 15 (LEVEL 4 – ON SNOW)

Specific Objectives:

- 1) Develop and improve the skier's balance and agility.
- 2) Assess Level 3 skating technique skills to ensure skiers are in the appropriate group (Free Skate, Diagonal Skate and One Skate)
- 3) Assess ski equipment to determine if appropriate for Level 4 skill development. Provide feedback to parents if equipment is inadequate.
- 4) Review Free Skate and Diagonal Skate.
- 5) Explore the ski area where the practice sessions are held.

Note: Skiers will require ski equipment for skating technique.

Teaching Aids Needed:

- Practice areas groomed for skating technique.
- Cones or other markers.
- Help from parents and other coaches.
- Trays for half the group; two tennis balls for each tray.

Skill	Description	Time
Ski Play (to warm up)	Varied speeds.	5 min.
Balance and Agility	<ol style="list-style-type: none"> 1) Skiers stand in place with skis in a "V" position. 2) Skiers balance on one ski, and touch the other ski with their hand. 3) Next the skiers balance on the other ski and touch the first ski with their hand. 4) Skiers edge the inside of one ski and then the other. 5) Repeat several times, occasionally edging both skis at the same time. 6) Skiers edge skis and sidestep. 	5 min.





	<p>7) Skiers sidestep or hop sideways as far as they can to see who can make the biggest mark in the snow when pushing off. Repeat several times and then reverse direction.</p> <p>8) Skiers sidestep or hop sideways and slightly forward as far as they can. Emphasize turning the body in the direction of the hop and gliding after the hop.</p>	
<p>Assess Level 3 Skills (skating technique)</p>	<p>Follow the Leader: The skiers follow one of the coaches who leads them through a number of techniques as they move through the ski playground.</p> <ol style="list-style-type: none"> 1) Have skiers Free Skate. 2) Have skiers Herringbone up a small hill. 3) Have skiers Free Glide, using high and low tuck, back down the hill. 4) Have skiers Diagonal Skate. 5) Have skiers Kick Turn. 6) During this exercise the skiers are assessed by the coach 	20 min.
<p>Free Skate (Review)</p>	<ol style="list-style-type: none"> 1) Coach demonstrates Free Skate and reviews key points. 2) Skiers practise the skill. <p>Waiver: The coach demonstrates by holding the shaft of a ski pole, shoulder width apart, with elbows “super-glued” to the hips. When the coach glides on a ski, the same side shoulder should be positioned over the glide ski. Emphasize that the poles should be level at all times (a tray with drinks!). This drill only works if the skiers can keep their elbows on their hips.</p>	10 min.





	<ol style="list-style-type: none"> 3) Emphasize aligning knee and hips/shoulder over the gliding ski. 4) Skiers do a single skate and glide to a stop. Repeat with the other foot. Emphasize knee and ankle flexion before kicking. Emphasize facing in the direction of the ski glide until they stop 5) Skiers use the poles by their handles, but do not plant their poles. Emphasize body alignment over each gliding ski 	
Game Time	<p>Waiter Race: Each skier or team is given a serving tray with two tennis balls or rubber balls. The skiers must ski a short course, holding the tray in front of them, without losing the balls. If skiers lose a ball they must stop and retrieve it. The course should contain turns to both the left and right.</p>	10 min.
Diagonal Skate (Review)	<ol style="list-style-type: none"> 1) Coach demonstrates and reviews key points. 2) Skiers practise Diagonal Skate without a hump. 3) Emphasize that the skis keep moving. 	5 min.
Game Time	<p>British Bulldog: The Bulldog is positioned in the middle of a flat open area, with the rest of the skiers behind a line at one end. At a command from the coach, the skiers try and cross to the line at the other side of the area without being tagged. If tagged, a skier becomes another Bulldog and helps the first Bulldog to tag skiers</p>	15 min.
Explore Ski Area	<p>Free Skate. Skiers explore the ski area in the vicinity under the supervision of the coaches. The coaches provide some one-on-one feedback.</p>	20 min.
Wrap Up (in day lodge)	<p>Conclude the session with hot chocolate, snacks and a short social time.</p>	15 min.





PRACTICE PLAN 16 (LEVEL 4 – ON SNOW)

SPECIAL ACTIVITY – CHRISTMAS

The period leading up to Christmas provides opportunities for a special activity that can be implemented with the minimum amount of preparation, while offering FUN and excitement for the participants. A Christmas activity might be as simple as a practice session using games that fit well with a Christmas theme: for example, all the coaches dressed as Santa's helpers; or Christmas goodies with hot chocolate at the day lodge following practice. This activity would usually be coordinated for all the ski "groups" by the club's SDP Programmer. Refer to the Introduction to Community Coaching Reference Material (section 5.5) and section 4.3.9 of this manual for more information.

Specific Objectives:

- 1) By using games, put into practice skills learned during regular practice sessions.
- 2) Have FUN!

Key Teaching Points:

- Plan for the activity and, if necessary, prepare the setting ahead of time.
- Provide suitable coaching support for the activity that has been selected.
- No formal ski instruction.
- Use opportunities for one-on-one technique instruction.

Teaching Aids Needed:

- Extra help from parents and other coaches.
- Depends on the activity.





PRACTICE PLAN 17 (LEVEL 4 – ON SNOW)

Specific Objectives:

- 1) Develop and improve the skier's balance and agility.
- 2) Review and introduce Diagonal Stride.
- 3) Develop and improve Double Poling and One-step Double Poling.
- 4) Review Skate Turn on the flats.
- 5) Review and introduce Kick Turn.

Note: Skiers will require ski equipment for classic technique.

Key Teaching Points:

Diagonal Stride

- ✓ Emphasize full extension of arms and legs.
- ✓ Emphasize forward lean.

Kick Turn

- ✓ Skier executes a Kick Turn to the right, on a slope.
- ✓ Skier executes a Kick Turn to the left, on a slope.
- ✓ Skier climbs a small slope using Kick Turn only.
- ✓ Common errors:
 - insufficient edging of ski.
 - uses poles to balance.
 - poles get in the way of ski action.

Teaching Aids Needed:

- Sufficient parallel sets of tracks to play Scooter games.
- Ski playground set up with an "Adventure Trail."
- Help from parents and other coaches.
- Cones or other markers.
- Pirate's Treasure.

Skill	Description	Time
-------	-------------	------





Ski Play (to warm up)	Varied speeds.	5 min.
Balance and Agility	<p>Marching Soldiers: Skiers walk on one spot, lifting knees high in front of chest.</p> <p>Flea Leaps: Skiers jump into the air (on their skis) and land softly in a balanced position. Knees should be bent when landing.</p> <p>One-Leg Pops: Skiers pop/spring off one leg, which is bent, and then land on it. Alternate legs.</p>	5 min.
Diagonal Stride (Review and introduce)	<p>Coach demonstrates and reviews key points.</p> <p>Scooter Glide: Skiers remove one ski and practise scootering and gliding on one ski for as long as possible. The contest is to see who can glide the longest. A variation of the game is to have the skiers count the number of pushes they require to cover the distance between the start line and finish line. This game encourages a more powerful push and a better glide.</p>	5 min.
Double Pole (Review)	<ol style="list-style-type: none">1) Coach demonstrates and reviews appropriate key points.2) Skiers swing arms forward and plant poles. Lift poles and repeat.3) Emphasize swinging arms forward, and not up as in a pendulum.4) Emphasize elbows slightly bent.5) Emphasize that poles have a slight slant on pole plant.6) Skiers use Double Poling to push themselves forward.7) Emphasize that trunk moves parallel to ground.	10 min.





<p>One-step Double Poling (Review)</p>	<ol style="list-style-type: none"> 1) The coach or role model demonstrates and reviews the key points. 2) Skiers stand in stationary position, drive arms forward without planting poles, and extend leg back without pushing forward at the same time. Double Pole and recover leg at the same time. Double Pole and recover leg, several times with the other leg, and then alternate legs. <p>Double Pole Scooter: Similar to the Diagonal Scooter, but both arms drive forward at the same time. Emphasize weight shift and planting free foot forward.</p> <ol style="list-style-type: none"> 3) Try this exercise using One-step Double Poling. Emphasize trunk action in poling. 4) Emphasize using the joints in order – trunk, shoulders, elbows, wrists. 	<p>10 min.</p>
<p>Skate Turn (on flats) (Review)</p>	<p>Coach demonstrates Skate Turn and reviews key points. Refer to Practice Plan 33 – Level 3 for more information.</p>	<p>10 min.</p>
<p>Game Time</p>	<p>Duck, Duck, Goose. Form a circle ten metres in diameter, with the skiers facing towards the centre. One skier is on the outside of the circle, skiing behind the group and saying “Duck, Duck, Duck” as he/she touches each of the other skiers on the back. When he/she touches a skier and says “Goose,” that skier must leave his/her place. Both skiers race around the circle to see who can be the first to get to the vacant position. The first one to get there wins. The unsuccessful skier then circles behind the group saying “Duck, Duck” etc. Variation for larger groups - two skiers skiing outside the circle, going in opposite directions. May or may not choose to use poles</p>	<p>10 min.</p>





Kick Turn (Review)	<ol style="list-style-type: none">1) Coach demonstrates and reviews key points.2) Skiers start on flats, linking Kick Turns so that they travel sideways.3) Skiers repeat exercise on gentle slope. Emphasize complete weight transfer and edging the ski.4) Repeat on a steeper slope.	10 min.
Game Time	Kick Turn Relay – 2: Set up start and finish lines approximately 60 metres apart, with two changeover markers in between. Between the two changeover markers, set up a relay exchange zone (approx. 10 metres wide). Form two-person teams. The first team members Double Pole to the first changeover marker, complete two Kick Turns, and proceed to the relay exchange zone (still Double Poling) where they tag their team mate. The second skiers Double Pole to the second changeover marker and complete two Kick Turns before skiing to the finish line.	10 min.
Ski Play	Adventure Trail: Set up a special course on the ski playground, about 500 or 700 metres in length, with uphill, downhill, flats and bumps, utilizing the different techniques – Free Skate, Herringbone, Side Stepping, Snowplow Turn, etc. The pirate's treasure - caches of goodies stashed at different points along the route (one per skier at each cache) - will make the journey more exciting.	20 min.
Wrap Up (in day lodge)	Conclude the session with hot chocolate, snacks and a short social time.	15 min.





PRACTICE PLAN 18 (LEVEL 4 – ON SNOW)

Specific Objectives:

- 1) Develop and improve the skier's balance and agility.
- 2) Review and introduce Free Skate.
- 3) Introduce Marathon Skate.
- 4) Review and introduce One Skate.

Note: Skiers will require ski equipment for skating technique.

Key Teaching Points:

Free Skate

- ✓ Skier aligns toes, knee, hips, body, and shoulders.
- ✓ Skier's hips and shoulders should face the direction of gliding ski until a push is initiated.
- ✓ Consistent glide on left and right skis.
- ✓ Knees and ankles flex before pushing off.
- ✓ During each glide, feet come close to each other.
- ✓ Upper body bends while poling.
- ✓ Emphasize gliding on flat ski.

Marathon Skate

- ✓ Skier places the out-of-track ski in a skating position, slightly in front of the in-track foot.
- ✓ Skier begins Double Poling in the skating position, then skates off the out-of-track ski and onto the in-track ski.
- ✓ Skier gets upright on the in-track ski, and then hips and shoulders turn in the skating direction.
- ✓ The pole plant is wider to allow for skating motion.
- ✓ Skier transfers weight from ski to ski.
- ✓ Skier is able to push self down the track Marathon Skating, for a minimum of 100 metres.
- ✓ Common errors:
 - weight stays on the glide ski.
 - heel comes off ski on glide ski.
 - while on skating ski, glide ski gets "left behind."
 - weight does not shift completely onto glide ski.

One Skate





- Emphasize the recovery foot comes under the body.
- Emphasize gliding on a flat ski.
- Emphasize the trunk action on Double Poling.

Teaching Aids Needed:

- Sufficient parallel sets of tracks to play Scooter games.
- Ski playground set up for the age and skill level of the skiers.
- Help from parents and other coaches.
- Cones or other markers; a soft ball.

Skill	Description	Time
Ski Play (to warm up)	Varied speeds.	5 min.
Balance and Agility	<p>Balance on one ski and bend down and touch the ski.</p> <p>Scooter: Remove a ski, and push with the free foot while gliding on the remaining ski. The foot plant should be flat, and forward of the gliding foot. The objective is for skiers to cover 50 metres with the least number of pushes. Variation: skiers compare the number of pushes for their right leg with the number of pushes for their left leg.</p>	5 min.





<p>Free Skate (Review and introduce)</p>	<p>1) Coach demonstrates and reviews key points. Waiter: The coach demonstrates by holding the shaft of a ski pole, shoulder width apart, with elbows “super-glued” to the hips. When the coach glides on a ski, the same side shoulder should be positioned over the glide ski. Emphasize that the poles should be level at all times (a tray with drinks!).</p> <p>2) Emphasize that knees and ankles flex before pushing off.</p> <p>3) Emphasize clicking heels together.</p> <p>4) Skiers practise a normal Free Skate without poles, and without clicking heels together, but still bringing their feet close together.</p>	<p>10 min.</p>
<p>Game Time</p>	<p>Ball Tag: The coach identifies one skier as “It.” “It” tags the other skiers by hitting them with a soft ball. If one of the skiers catches the ball without the ball hitting the ground, the thrower (“It”) has to ski a small 100 metre circuit before he/she can return to the game. Variation: use more than one ball and more than one “It” – about a third of the skiers could be “It.” No poles.</p>	<p>10 min.</p>





<p>Marathon Skate (Introduce)</p>	<ol style="list-style-type: none">1) Coach demonstrates and reviews key points.2) Skiers balance on right ski, in the track. Keeping the left ski just off the snow, the skiers rotate on the right leg so the left ski changes direction from pointing down the track, to angling off to the left, and back again. Alternate legs.3) Practise the skill with arms forward. Widen the space between the hands as the ski angle widens, and return arms to initial position as the ski angle narrows.4) Next, practise the skill with an emphasis on transferring weight onto skating ski, and back.5) Practise again with an emphasis on pushing the gliding ski forward when the weight is on the skating ski. <p>Freeze Skate: Skiers Marathon Skate on the command “Go.” On the command “Freeze,” skiers finish their skate, after which they must glide and balance on the glide leg until the command “Go.”</p>	<p>15 min.</p>
<p>Game Time</p>	<p>Spud: Each skier is given a number from one to ten. The coach throws a ball high as possible, calling out a number up to ten. All the skiers scatter except the skier whose number was called (the “ball catcher”). The “ball catcher” attempts to catch the ball. Once the “ball catcher” catches the ball, he/she yells out “stop” and all other skiers must stop. If the “ball catcher” catches the ball without it hitting the ground, the other skiers automatically earn three ‘strides.’</p> <p>The “ball catcher” tries to hit one of the skiers with the ball (who may now use the three strides if they earned them). The skiers are allowed to bend to dodge the ball but must not move their skis. If skiers get hit, they have to take a letter from the word Spud, and then they have to hit one of their team mates with the ball. If they miss, they have to take another letter from the word Spud, and try again to hit one of their team mates. No poles.</p>	<p>10 min.</p>





<p>One Skate (Review and introduce)</p>	<p>1) Coach demonstrates and reviews key points. Double Double Skate: Skiers Double Pole twice on each side. During the initiation of the second poling, the skate and weight transfer to the other ski takes place.</p> <p>2) Skiers practise One Skate with an emphasis on aligning knee, hip, and same side shoulder over gliding ski at the start of the Double Poling.</p> <p>3) Emphasize upper body bending during Double Poling.</p> <p>4) Emphasize that the foot comes underneath the body.</p> <p>5) Emphasize that the push is to the side, and the skating ski comes off the snow flat (tip and tail at the same time).</p>	<p>10 min.</p>
<p>Game Time</p>	<p>Cops and Robbers: One coach is the “cop.” The skiers are “robbers.” The robbers are safe as long as they are in a marked area (hideout). However, they cannot stay in the hideout for more than five seconds. One of the marked areas is a prison. When robbers are tagged by a cop, they must go to prison. When captured robbers are tagged by a free robber, they can go free.</p>	<p>10 min.</p>
<p>Ski Play</p>	<p>Skiers use the ski playground under the supervision of the coaches. Coaches provide one-on-one instruction.</p>	<p>20 min.</p>
<p>Wrap Up (in day lodge)</p>	<p>Conclude the session with hot chocolate, snacks and a short social time.</p>	<p>15 min.</p>





PRACTICE PLAN 19 (LEVEL 4 – ON SNOW)

Specific Objectives:

- 1) Develop and improve the skier's balance and agility.
- 2) Review and introduce Diagonal Stride.
- 3) Review and introduce Herringbone.
- 4) Develop and improve Step Turn.

Note: Skiers will require ski equipment for classic technique.

Key Teaching Points:

❑ Diagonal Stride

- ✓ Skier demonstrates noticeable glide (50 cm+) on each lead ski.
- ✓ Recovery foot lands beside, or in front of (not behind), the gliding foot 50-70% of the time.
- ✓ Skier maintains a forward upper body lean.
- ✓ Poles are planted shoulder width apart; pole tip planted opposite lead foot.
- ✓ Pole tips are behind pole handles throughout skill.

❑ Herringbone

- ✓ Skier maintains "V" shape with skis.
- ✓ Skier climbs 15 metres up moderate slope without stopping.
- ✓ Skier uses diagonal arm action.
- ✓ Skier uses inside edges of skis well.
- ✓ Skier plants pole tips behind, and to the side of feet, with handles/hands just below shoulder height.

❑ Step Turn

- ✓ Skier glides down small, untracked hill in the Ready Position.
- ✓ While gliding, the skier shifts weight onto one ski.
- ✓ Skier points unweighted ski in new direction.
- ✓ Skier edges ski and shifts body onto "unweighted ski", brings other ski parallel.
- ✓ Skier repeats sequence three to five steps in one direction, and then three to five steps in the another direction.
- ✓ Skier consistently keeps poles in the Ready Position.





Teaching Aids Needed:

- Sufficient parallel sets of tracks to play Scooter games.
- Ski playground set up for the age and skill level of the skiers.
- Help from parents and other coaches.
- Cones or other markers; surveyors tape; a penny.
- Tape measure.

Skill	Description	Time
Ski Play (to warm up)	Varied speeds.	5 min.
Balance and Agility	Follow the Leader: Skiers follow coach. Skiers stand on left leg only. Skiers stand on right leg only. Skiers stand on left leg only and touch the left ski with the left hand. Skiers stand on right leg only and touch the right ski with the right hand. Skiers run on the spot lifting ski tails off snow. Skiers execute several Kick Turns.	5 min.
Diagonal Stride (Review and introduce)	<p>1) Coach demonstrates and reviews the appropriate key points.</p> <p>Measured Scooter: Mark off one track every 0.5 metres. Mark other tracks at 0.75 metre, 1 metre and 1.25 metre intervals. Have the skiers start in the first track. If they continually glide past each marker, they move to the next track, etc.</p> <p>2) Repeat using Diagonal Stride with poles.</p> <p>3) Emphasize recovery foot beside or in front.</p> <p>4) Emphasize forward lean, keeping hips forward.</p>	10 min.





Game Time	Scooter Relay: Skiers remove one ski. Divide the group into two teams. Begin on a gentle slope with at least two sets of tracks. One half of the team is placed at the top of the slope and the other half at the bottom. One skier from each team scooters up the hill (helps emphasize bent ankle and knee) and tags an uphill teammate who scooters down the hill (helps emphasize balance and glide) and tags the downhill teammate. Repeat using opposite leg.	10 min.
Herringbone and Step Turn (Review and introduce)	Coach or role model demonstrates and reviews key points.	10 min.
Free Glide – High Tuck and Low Tuck (Review)	<ol style="list-style-type: none">1) Coach or role model demonstrates and reviews key points.2) Skiers Free Glide with an emphasis on hands forward and knees bent.3) Begin with a High Tuck, then a Low Tuck.4) Switch from one to the other on the same run down the hill. <p>Streamers: Place two different coloured streamers or surveyors' tapes above the tracks. The streamers should be at a height that would just touch the back of a skier in a High Tuck. Skiers go down the hill in a Low Tuck staying below the streamers. Then they ski down the hill in a High Tuck, touching the streamers with their back, but not their head. The next step is for the skiers to do one colour in a High Tuck and the other in a Low Tuck. The streamers must be set up in such a way that they do not pose any danger to the skiers.</p>	15 min.





<p>Game Time</p>	<p>Penny, Penny, Who's Got the Penny? Divide the skiers into two groups. One skier on one of the teams is given a penny. The other team does not know which opposing member has the penny. The penny carrier has to try and get the penny to his/her team's castle, which is in the opponent's zone. The person who has the penny must show it if tagged. The rest of the team acts as decoys. No poles.</p>	<p>10 min.</p>
<p>Game Time</p>	<p>Head to Head Tag: Move to an area where there are several classic tracks set parallel to each other. Divide the group into pairs. Have the skiers lie down on their backs in the middle of the tracks, with their heads together (one metre apart), and legs down the track. Identify one half of each pair of skiers as "bears" and the other half as "dogs". When the coach yells out "bears", the bears get up as fast as they can and Diagonal Stride down their end of the track. The dogs get up as fast as they can at the same time and try to tag the bear before the bear reaches the end of the track. The opposite occurs if the "dogs" are called out.</p>	<p>10 min.</p>
<p>Ski Play</p>	<p>Skiers use the ski playground under the supervision of the coaches. Coaches provide one-on-one instruction.</p>	<p>20 min.</p>
<p>Wrap Up (in day lodge)</p>	<p>Conclude the session with hot chocolate, snacks and a short social time.</p>	<p>15 min.</p>





PRACTICE PLANS 20 – 21 (LEVEL 4 – ON SNOW)

HOLIDAY SKI CAMP

Scheduling an overnight (two day) ski camp in your plans for the season is an excellent way to enhance your skill development program. Children will benefit from being introduced to a ski camp experience by the time they are nine years of age, and the Christmas holidays provide an opportune time for this to take place.

Ideally the camp will be a club-organized program that can be adapted to the needs of the different age groups. To meet the primary objectives of the activity, it is important that this is an overnight camp experience. In addition, because of the age of the skiers, it may be preferable to begin the camp at noon on day one, and end in early afternoon on day two. Be cautious about using one-day camps for skiers at this age – this format can be seen as a never-ending practice session and be counter-productive.

Specific Objectives:

- 1) Provide an opportunity for the skier to develop friendships with other skiers their own age.
- 2) Team building.
3. Increase awareness of the lifestyle associated with cross-country skiing, including good nutritional habits.
- 4) Develop and improve ski skills learned during regular practice sessions.
- 5) Have FUN!

Key Teaching Points:

- Keep the skiers active, but not necessarily with ski activities.
- Ski activities should be short and varied.
- The skiers will require close supervision because of their age.
- All activities need to be appropriate for the age and skill level of the skiers.
- Utilize every opportunity to encourage the development of independent athletes – ski care, preparing meals, eating appropriate foods, clean up duty, curfew, dressing appropriately for each activity, etc.
- Keep in mind that a program that is too difficult will discourage future involvement.

Teaching Aids Needed:

- Competition Coaching – Introduction Reference Material.





- Suitable coaching support for the activity that has been selected.
- Extra help from parents and other coaches.
- Depends on the activity.

Note: The ultimate objective is to motivate skiers to learn more, ski more and further participate in the sport.





PRACTICE PLAN 22 (LEVEL 4 – ON SNOW)

NEW YEAR ACTIVITY

Participation in a club activity/event exposes young skiers and their families to the wide range of programs that clubs offer, as well as the family orientation of the sport. If you live in a community that doesn't offer programs of this kind, refer to section 5.5 of the Introduction to Community Coaching Reference Material for some ideas and create a "special activity" of your own. This could be a Moonlight Ski, a Lantern Ski, Turkey Glide, a trek to a cabin/lake for lunch and some games, or a similar activity.

Specific Objectives:

- 1) Introduce skiers to the club at large.
- 2) Introduce skiers to a new type of cross-country ski experience.
- 3) Practice skills learned during regular practice sessions.
- 4) Have FUN!

Key Teaching Points:

- Plan for the activity and, if necessary, prepare the setting ahead of time.
- Provide suitable coaching support for the activity that has been selected.
- No formal ski instruction.
- Use opportunities for one-on-one technique instruction.

Teaching Aids Needed:

- Extra help from parents and other coaches.
- Depends on the activity.





PRACTICE PLAN 23 (LEVEL 4 – ON SNOW)

Specific Objectives:

- 1) Develop and improve the skier's balance and agility.
- 2) Review Diagonal Stride.
- 3) Review and introduce Double Poling.
- 4) Introduce Parallel Side-slipping.
- 5) Review Snowplow and Half-Snowplow Braking.

The skier will require ski equipment for classic technique.

Key Teaching Points:

Double Poling

- ✓ Emphasize keeping legs relatively straight.
- ✓ Use joints in order – trunk, shoulders, elbows and wrists.
- ✓ Keep hips above or ahead of toes on pole plant.
- ✓ Common errors:
 - skier sits back when planting poles.
 - elbows straighten before shoulders extend.
 - trunk comes up while poles are still in the snow pushing forward.

Parallel Side-slipping

- ✓ Skier maintains Ready Position.
- ✓ Skis remain parallel while slipping down the hill sideways.
- ✓ Skier demonstrates control by stopping mid-slope.
- ✓ Skier demonstrates this skill facing both directions.
- ✓ Common errors:
 - skier doesn't side slip both skis at the same time.
 - one or both skis catch edges.
 - skier is unable to side slip down the Fall Line (moves forward while slipping)

Teaching Aids Needed:

- Sufficient parallel sets of tracks to play Scooter games.
- Help from parents and other coaches.
- Cones or other markers.





Skill	Description	Time
Ski Play (to warm up)	Varied speeds.	5 min.
Balance and Agility	Bobbing Stork: The skiers stand on one ski, bend forward at the waist, and then stand upright again with their shoulders, hips and ankles lined up one on top of the other. They appear to be bobbing like a bird on one leg. Flying Stork: The skiers leap into the air by pushing off with both legs. They land on one leg. Alternate legs.	5 min.
Diagonal Stride (Review)	Coach demonstrates and review key points. Scooter Side Car: The coach pairs up the skiers according to their height. Skiers remove the ski opposite to the one their partner removes, and take positions behind the start line. The partners stand side by side with their arms around shoulder and waist, and their free foot on the inside. When starting, the partners propel themselves forward by kicking at the same. Emphasize how far the skiers can glide in a single kick. Alternate skis and repeat.	10 min.
Game Time	Lemans Start Pole Relay: Set up two exchange “zones”. Skiers take their poles to the first exchange zone, leave them there and return to the start line. When the relay begins, the skiers ski to the first exchange zone, pick up their poles, hold them at the balance point, and then ski to the second exchange zone. At the second exchange zone, the skiers put their poles on and ski to the finish line. Vary the emphasis between speed and the longest strides.	10 min.





<p>Double Poling (Review and introduce)</p>	<ol style="list-style-type: none"> 1) Coach or role model demonstrates and reviews key points. 2) Skiers swing arms forward and plant poles, lift poles and repeat. 3) Emphasize hips forward on pole plant (you would fall over if you didn't plant your poles). 4) Emphasize swinging arms forward, and not up as in a pendulum. 5) Emphasize elbows should be slightly bent. 6) Emphasize that poles have a slight slant on pole plant. 7) Skiers Double Pole, pushing themselves forward. 8) Emphasize that legs stay straight for most of the poling action. 9) Emphasize that the shoulder joint is locked when the trunk is bending. 	<p>10 min.</p>
<p>Parallel Side Slipping (Introduce)</p>	<ol style="list-style-type: none"> 1) Coach demonstrates and reviews key points. 2) Skiers stand on a flat area in the Ready Position and edge their skis from side to side. 3) Skiers Sidestep part way up a well packed, fairly steep hill. 4) Emphasize edging the uphill side of the skis. 5) Slowly reduce the edge until the skiers start to slip, then re-edge. 6) Repeat, with slightly longer and longer slips. 	<p>10 min.</p>
<p>Snowplow and Half-Snowplow Braking (Review)</p>	<ol style="list-style-type: none"> 1) Coach demonstrates and reviews key points. 2) Skiers switch from a braking, Half-Snowplow on one side to a full Snowplow. 3) Skiers switch from a braking, Half-Snowplow on one side, to a braking, Half-Snowplow on the other side. 	<p>10 min.</p>





Game Time	Crows and Owls: Form two equal teams. One team will be “Crows” and the other team “Owls”. The two teams form lines with one team facing the other. The lines need to be marked by ski poles or a similar marker at each end. The two lines should be 20 to 30 metres apart. For each team, its own line is its “home”. The coach then makes a statement that is easily identified as either true or false. If it is true, the Owls (who are wise and honest) chase the Crows; if it is false the Crows (who are sly, devious and don’t always know the truth) chase the Owls. The team being chased must turn around and ski past the poles identifying its home line to be safe. Skiers who are tagged by a skier from the other team before they get safely home must join that team.	10 min.
Ski Play	Skiers use the ski playground under the supervision of the coaches. Coaches provide one-on-one instruction.	20 min.
Wrap Up (in day lodge)	Conclude the session with hot chocolate, snacks and a short social time.	15 min.





PRACTICE PLAN 24 (LEVEL 4 – ON SNOW)

Specific Objectives:

- 1) Develop and improve the skier's balance and agility.
- 2) Review and introduce Free Skate.
- 3) Review and introduce Marathon Skate.
- 4) Review and introduce One Skate.
- 5) Introduce Two Skate.

The skier will require ski equipment for skating technique.

Key Teaching Points:

Free Skate

- ✓ Emphasize flat ski (edge to edge).
- ✓ Emphasize that the kick is to the side, not back (tip and tail of ski come off snow at the same time).
- ✓ Emphasize good weight transfer to the glide ski.

Marathon Skate

- ✓ Skier pushes to the side and not back.
- ✓ The recovery foot comes underneath the body.

One Skate

- ✓ Emphasize flat ski (edge to edge).
- ✓ Emphasize that the leg-push is to the side, not back (tip and tail of ski come off snow at the same time).
- ✓ Emphasize good weight transfer to the glide ski.

Two Skate

- ✓ Consistent glide on left and right ski.
- ✓ Knees and ankles flex before pushing off.
- ✓ During each glide, feet come close to each other.
- ✓ Upper body bends while poling.
- ✓ Common errors:
 - skier doesn't transfer weight completely onto non-poling side.
 - upper body turns too early.





- unequal glide.
- skier is unable to execute the skill on both sides.

Teaching Aids Needed:

- Help from parents and other coaches.
- Cones or other markers; a soft ball.
- Brightly coloured handkerchief or surveyors' tape.

Skill	Description	Time
Ski Play (to warm up)	Varied speeds.	5 min.
Balance and Agility	<p>Ball Tag: The coach identifies one skier as “It”. “It” tags the other skiers by hitting them with a soft ball. If one of the skiers catches the ball without the ball hitting the ground, the thrower (“It”) has to ski a small 100 metre circuit before returning to the game. Variation: use more than one ball and more than one “It” – about a third of the skiers could be “It”. No poles.</p>	5 min.
Free Skate (Review and introduce)	<ol style="list-style-type: none"> 1) Coach demonstrates and reviews key points. Waiver: The coach demonstrates by holding the shaft of a ski pole, shoulder width apart, with elbows “super-glued” to the hips. When the coach glides on a ski, the same side shoulder should be positioned over the glide ski. Emphasize that the poles should be level at all times (a tray with drinks!). 2) Emphasize that knees and ankles flex before pushing off. 3) Emphasize putting down flat ski. 	10 min.





<p>Marathon Skate (Review and introduce)</p>	<ol style="list-style-type: none"> 1) Coach demonstrates and reviews key points. 2) Skiers put skating ski on snow, edge and push off. 3) Repeat with emphasis on shifting weight onto skating ski and back. 4) Repeat with emphasis on pushing glide ski forward when weight is on skating ski. 5) Emphasize pushing to the side and not back. 6) Emphasize that the skating leg recovers to a position where the foot is underneath the body slightly ahead of the glide foot. 	<p>10 min.</p>
<p>Game Time</p>	<p>Catch the Dragon's Tail. The skiers in the group line up one behind one other. Eight to ten skiers is ideal. The skiers put their arms around the waist of the skier in front of them. The last skier in the line tucks a brightly coloured handkerchief into his/her back pocket or the back of the toque. To work up steam, the dragon should then make a few scary cries. At a signal from the coach, the dragon begins chasing its own tail, the objective being for the skier at the head of the line to snatch the handkerchief. When the skier at the head of the line finally captures the tail, he/she wears the handkerchief and becomes the new tail. The skier who was second from the front of the line then becomes the new leader. A variation is to have two dragons (chains of skiers) trying to catch the tail of the other.</p>	<p>10 min.</p>





One Skate (Review and introduce)	<ol style="list-style-type: none">1) Coach demonstrates and reviews key points. Double Double Skate: Skiers pole with toes, knees, hips, body and shoulders aligned in the direction of the gliding ski on the first push. The skiers pole again on the same side. Half way through the second poling, weight is transferred and leg pushes off ski.2) Emphasize long glide, under control.3) Return to normal One Skate, emphasizing that Double Poling starts in the direction of the gliding ski.4) Emphasize ankle and knee flexion on push off.5) Emphasize pushing to side and not back.	10 min.
Game Time	Snow Hockey: Use old hockey sticks (floor hockey or ball hockey, with plastic blades preferable), and soccer sized coloured play ball. Coaches and parents need to closely monitor the safe use of the sticks.	10 min.
Two Skate (Introduce)	<ol style="list-style-type: none">1) Coach demonstrates and reviews key points.2) Skiers begin with a One Skate, Double Pole.3) When the skier transfers their weight, they should just be completing their poling action.4) During the weight transfer to the original ski, the skier drives the arms forward to Double Pole5) Emphasize weight transfer on both sides.6) Emphasize that Double Poling starts in the direction the ski is pointing.	15 min.
Ski Play	Skiers use the ski playground under the supervision of the coaches. Coaches provide one-on-one instruction.	20 min.
Wrap Up (in day lodge)	Conclude the session with hot chocolate, snacks and a short social time.	15 min.





PRACTICE PLAN 25 (LEVEL 4 – ON SNOW)

Specific Objectives:

- 1) Develop and improve the skier's balance and agility.
- 2) Introduce Interval Start procedures.
- 3) Develop and improve Sidestepping.
- 4) Develop and improve Half-Snowplow Braking.

The skier will require ski equipment for classic technique.

Teaching Aids Needed:

- Trails groomed for classic technique, including a 200 metre loop that incorporates some up and down terrain. Start "gate" set up to practice Interval Starts.
- Ski playground set up appropriately for the age and skill level of the skier.
- Colored water, posts for start gate, and stop watches.
- Enough large soft balls for each skier in the group; basket or hoop.
- Ten 2-metre long ropes.
- CCC Officials Manual - section pertaining to Interval Start procedures.
- Enough race bibs (in sequence) for each skier in the group.

Skill	Description	Time
Ski Play (to warm up)	Varied speeds.	5 min.
Balance and Agility	<p>Marching Soldiers: Skiers walk on one spot, lifting knees high in front of chest.</p> <p>Flea Leaps: Skiers jump into the air (on their skis) and land softly in a balanced position. Knees should be bent when landing.</p> <p>One-Leg Pops: Skiers pop/spring off one leg, which is bent, and then land on it. Alternate legs.</p>	5 min.





Side Stepping (Review)	1) The coach demonstrates and reviews the key points. Refer to 4.3.1 for detailed information. 2) Skiers practise this skill on a fairly steep hill.	10 min.
Game Time	<p>This exercise should take place on one of the ski trails.</p> <p>Tracking: Coordinate skiers in a tightly packed, single-file line along the trail. Begin skiing. Every 30 seconds, the coach calls “Track” and the skier at the front of the line steps out of the way. This skier continues to ski (they may have to Double Pole so that they don’t interfere), but at a slightly slower pace until the line of skiers goes by. The skier from the front of the line then jumps back into line at the end of the file of skiers.</p> <p>Pass: Continue the line of skiers as above, but change the command to “Pass”. In this game, the last person in line jumps out of the line and skis as fast as they can to the front of the line. In order for the last skier to pass the line of skiers, the coach may have to control the speed of the group by skiing in front. The “passing” skier then jumps back into the line behind the coach. Note this can be done on appropriate downhill sections as well.</p>	15 min.
Half-Snowplow Braking (Review)	1) The coach demonstrates and reviews key points. Refer to section 4.3.3 for additional information. 2) Skiers practise this skill on a fairly steep hill.	10 min





<p>Game Time</p>	<p>Uphill Basketball: Skiers are given a large size ball that they hold in front of their chest, using both hands. The skiers Side Step up the hill carrying the ball, and then return back down Half-Snowplow Braking, still holding the ball. At the bottom of the hill the skier throws the ball into a basket or through a hoop, depending on how the game is set up. Option: place two 2-metre long ropes perpendicular to the Fall Line for the skiers to Side Step over during the uphill portion of the game.</p>	<p>10 min.</p>
<p>Relay Exchange (Review)</p>	<ol style="list-style-type: none"> 1) Practise relay exchanges in a properly marked out exchange zone. 2) Refer to Practice Plans 25 and 26 for more information. 	<p>10 min.</p>





Individual Start Procedures	<ol style="list-style-type: none">1) Set up a “competition course” 200 metres in length. Clearly mark the actual start “gate”, and the area where the skiers line up for the start.2) Have the skiers pick up their “bibs” and put them on.3) The “Starter”, “Assistant Starter” and one or two adults (acting as competitors) demonstrate a correct start.4) The coach explains the key points to the skiers.5) Start each skier in the group individually, 15 seconds apart.6) Use correct countdown procedures,7) Skiers should leave the start gate using the One-step Double Poling technique when first attempting this exercise. After they have cleared the start gate they may chose to switch to Diagonal Stride.8) The skiers complete the 200 metre loop and return to an identified “finish” area.9) Repeat with the Starter holding a long stick or ski pole to simulate the start-wand used in electronic timing.10) Do not time this event. Use watches for the countdown and starting the skiers.	20 min.
Ski Play	Skiers use the ski playground under the supervision of the coaches. Coaches provide some one-on-one instruction.	20 min.
Wrap Up	Conclude the session with hot chocolate, snacks and a short social time at the day lodge.	15 min.





PRACTICE PLAN 26 (LEVEL 4 – ON SNOW)

Specific Objectives:

- 1) Develop and improve the skier's balance and agility.
- 2) Introduce Heat Sprint Start procedures.
- 3) Develop and improve Free Skate.
- 4) Develop and improve One Skate.

The skier will require ski equipment for skating technique.

Key Teaching Points:

- Although the Heat Sprint format is essentially a series of elimination rounds ("Round Robin"), the activity can easily be adapted to allow all the participants to take part in the same number of heats.

Teaching Aids Needed:

- Trails groomed for skating technique, including a 200 metre loop that incorporates up and down terrain and changes in direction (not straight out and back).
- Ski playground set up appropriately for the age and skill level of the skier.
- Extra help from parents and other coaches.
- Coloured water, cones or other markers for start and finish areas.
- Stop watches and enough race bibs for each skier in the group.
- CCC Officials Manual – section pertaining to Individual (Heat) Sprints.

Skill	Description	Time
Ski Play (to warm up)	Varied speeds.	5 min.





Balance and Agility	<p>Bobbing Stork: The skier stands on one ski, bends forward at the waist, and then stands upright again with their shoulders, hips and ankles lined up one on top of the other. They appear to be bobbing like a bird on one leg.</p> <p>Flying Stork: The skier leaps into the air by pushing off with both legs. They land on one leg. Alternate legs.</p>	5 min.
Free Skate (Review)	<ol style="list-style-type: none">1) Coach demonstrates and reviews key points. Refer to section 4.3.5 for additional information.2) Skiers practise the skill.	5 min.
Game Time	<p>This exercise should take place on one of the ski trails.</p> <p>Tracking: Coordinate skiers in a tightly packed, single-file line along the trail. Begin skiing. Every 30 seconds, the coach calls “Track” and the skier at the front of the line steps out of the way. This skier continues to ski (they may have to Double Pole so that they don’t interfere), but at a slightly slower pace until the line of skiers goes by. The skier from the front of the line then jumps back into line at the end of the file of skiers.</p> <p>Pass: Continue the line of skiers as above, but change the command to “Pass”. In this game, the last person in line jumps out of the line and skis as fast as they can to the front of the line. In order for the last skier to pass the line of skiers, the coach may have to control the speed of the group by skiing in front. The “passing” skier then jumps back into the line behind the coach. Note this can be done on appropriate downhill sections as well.</p>	15 min.





<p>One Skate (Review)</p>	<ol style="list-style-type: none"> 1) Coach demonstrates the One Skate. 2) Skiers practise the skill. <p>Double Double Skate: The skiers Double Pole twice on one side before weight shifting to the other side. Repeat. If a skier is proficient and space allows, Double Pole three times, four times, etc.</p>	<p>10 min.</p>
<p>Heat Sprints</p>	<ol style="list-style-type: none"> 1) Set up a sprint course 200 metres in length, with four start lanes wide enough for the skiers to use skating technique. 2) Clearly mark the start and finish areas, and the location where the skiers should wait between heats. 3) Have the skiers pick up their “bibs” and put them on. 4) The “Starter”, “Assistant Starter” and three or four adults (acting as competitors) demonstrate a correct start procedure. 5) The coach explains the key points to the skiers. 6) Begin the “heats” (preferably four skiers per heat). 7) Use correct start procedures. 8) Skiers can depart from the start line using skating technique. 9) Skiers complete the 200 metre loop and return to the “finish” area. 10) Direct the finishing skiers to the location where they should wait for their next turn. 11) Repeat. No timing. 	<p>25 min.</p>





Game Time	Crows and Owls: The objective of this game is to work on turning from a stationary position and forward movement without poles. Form two equal teams. One team will be “Crows” and the other team “Owls”. The two teams form lines with one team facing the other. The lines need to be marked by ski poles or a similar marker at each end. The two lines should be 20 to 30 metres apart. For each team, its own line is its “home”. The coach then makes a statement that is easily identified as either true or false. If it is true, the Owls (who are wise and honest) chase the Crows; if it is false the Crows (who are sly, devious and don’t always know the truth) chase the Owls. The team being chased must turn around and ski past the poles identifying its home line to be safe. Skiers who are tagged by a skier from the other team before they get safely home must join that team.	10 min.
Ski Play	Skiers use the ski playground under the supervision of the coaches. Coaches provide some one-on-one instruction.	20 min.
Wrap Up	Wrap up with a short information session on the Special Activity coming up, and how to prepare for it. Conclude the session with hot chocolate, the treasure findings and a short social time at the day lodge.	15 min.





PRACTICE PLAN 27 (LEVEL 4 – ON SNOW)

SKI TOURNAMENT

Specific Objectives:

- 1) Introduce skiers to a new type of cross-country ski experience.
- 2) Practice skills learned during regular practice sessions.
- 3) Have the group work together as a team.
- 4) Have the children develop new ski-friends.

Note: Skiers will require both classic and skating equipment for this session. As a minimum, skiers will require skating length poles and classic skis with glide wax from tip to tail (i.e. the grip wax removed from the grip zone) for the skating activities.

Key Teaching Points:

- Prepare the skiers in advance for this activity.
- Provide suitable coaching support.
- No formal ski instruction. Use opportunities for one-on-one technique instruction.

Teaching Aids Needed:

- Refer to Section 8 for detailed information about Ski Tournaments and the responsibilities of the coaches.
- Extra help from parents.





PRACTICE PLAN 28 (LEVEL 4 – ON SNOW)

Specific Objectives:

- 1) Develop and improve the skier's balance and agility.
- 2) Review and introduce Diagonal Stride.
- 3) Review Parallel Side Slipping.
- 4) Review and introduce Snowplow Turn.

Note: Skiers will require ski equipment for classic technique.

Key Teaching Points:

Diagonal Stride

- ✓ Noticeable glide (60 - 100 cm) on each foot.
- ✓ Glide is equal on each foot.
- ✓ Recovery foot lands beside or in front of (not behind) the gliding foot 70-100% of the time.
- ✓ Rear leg is fully extended at the end of the push.
- ✓ Skier maintains a distinct forward upper body lean (approximately 45 degrees).
- ✓ When planting poles, hands are forward at shoulder height, and each pole tip is planted beside or behind opposite lead foot.
- ✓ Pole plants should be consistent and arms should extend past hips.
- ✓ Common errors:
 - recovery foot lands behind gliding foot.
 - skier compensates leaning forward by sticking hips back.
 - arm poling finishes in front of hips.

Snowplow Turn

- ✓ Skier shows some "snowplow" wedge when changing direction.
- ✓ Skier changes direction, both left and right, while plowing.
- ✓ Pressure to the downhill ski is seen by increased flexing at the ankle and knee joints as the skier completes the turn. At this point, most of the body's weight should be on the downhill ski.
- ✓ Safely stops at the bottom of the slope.

Teaching Aids Needed:

- Sufficient parallel sets of tracks to play Scooter games.
- Help from parents and other coaches.





- ☐ Cones or other markers; measuring tape; colored clothes pins.

Skill	Description	Time
<p>Ski Play (to warm up)</p>	<p>Varied speeds.</p>	<p>5 min.</p>
<p>Balance and Agility</p>	<ol style="list-style-type: none"> 1) Skiers run in place on their skis, changing the tempo from slow to fast. 2) Have skiers walk on one spot extending their leg backwards. 3) Have skiers balance on one leg with the other extended backwards. Hold that position for three seconds and then switch. <p>Sizzling Snow: While remaining in one place the skiers step from ski to ski, keeping only one ski on the burning snow at a time. Have the skiers “hiss” as the snow “burns their skis”.</p>	<p>5 min.</p>
<p>Diagonal Stride (Review and introduce)</p>	<ol style="list-style-type: none"> 1) Coach demonstrates and reviews key points. 2) Skiers practise the skill with an emphasis on kick starting early. <p>Measured Scooter: Mark off one track every 0.75 metres. Mark other tracks at 1 metre, 1.25 metre and 1.5 metre intervals. Have the skiers start in the first track. If they continually glide past each marker, they move to the next track, etc.</p> <ol style="list-style-type: none"> 3) Repeat using Diagonal Stride with poles. 4) Emphasize recovery foot beside or in front. 5) Emphasize forward lean, keeping hips forward. 6) Next practise “arms only Diagonal Stride”. Keeping legs rigid, skiers stand upright and diagonally pole down the track. Repeat, leaning forward at an approximately 45 degree angle. Have the skiers think about which position is faster (leaning forward should be). 	<p>15 min.</p>





	<p>7) Repeat with a full extension of arms past hips.</p> <p>8) Diagonal Stride with arms and legs back in the marked tracks again.</p>	
Game Time	<p>Wolf Ring: A defined area with both perimeter and diameter lines is established for the game. Skiing is permitted around the perimeter and across each of the diameters, but in one direction only. A hunter, “the wolf”, chases the rabbits within the defined area. When the wolf tags a rabbit, that person becomes a wolf as well. The game continues until the last rabbit is tagged. The size of the area can vary according to the age of the participant. The coach may or may not decide to choose to use poles depending on space available to play the game. Refer to section 4.3.9 for an illustration.</p>	10 min.
Parallel Side Slipping (Review)	<ol style="list-style-type: none"> 1) Coach or role model demonstrates and reviews key points. 2) Skiers practise sliding and edging their skis. Red Light, Green Light: The coach is the policeman, and is positioned at the top of the hill. The skiers are positioned along a start line on the slope near the top of the hill. When the policeman says “green light” the skiers begin Side Slipping down the hill. When the policeman says “red light” the skiers stop. When caught moving on a red light, skiers have to sidestep back to the start line at the top of the hill. The game ends when the first skier crosses the finish line at the bottom of the hill. 3) As skills become more proficient, move the skiers to areas that have bumps and hollows. 4) Following the game, have skiers Side Slip two metres and stop; redirect skis slightly downhill; Snowplow Turn, Side Slip in other direction. 5) Repeat. 	15 min.





Game Time	<p>Clothes Pin Tag: This game is played in a ski pole circle. Choose three “Rabbits” and give the rest of the group three clothes pins each. The winner is the person who can pin a clothes pin on the collar or hood of each of the “Rabbits”. Note: After a skier pins a “Rabbit”, he/she has ten seconds to move away. Clothes pins should be coloured to confirm who has actually left their clothes pin on a Rabbit. You will need several colours, so you may need to paint some pins in order to have enough variety. No poles.</p>	10 min.
Snowplow	<p>Coach demonstrates and reviews key points. Emphasize going slow and staying in control.</p>	5 min.
Game Time	<p>Chain Tag: Establish a playing area with boundaries, with one skier as “It”. When “It” tags another skier, they hold hands and try and catch others. The skiers in the chain are not allowed to let go hands or move out of bounds, so the group must work cooperatively as the chain gets longer.</p>	10 min.
Explore a Ski Trail	<p>Skiers explore a designated trail under the supervision of the coaches. The coaches provide some one-on-one technique instruction.</p>	20 min.
Wrap Up (in day lodge)	<p>Conclude the session with hot chocolate, snacks and a short social time.</p>	15 min.





PRACTICE PLAN 29 (LEVEL 4 – ON SNOW)

DOWNHILL GAMES

Specific Objectives:

- 1) Develop and improve the skier's balance and agility on downhills.
- 2) Provide the skier with an opportunity to focus on downhill technique skills.

Note: Skiers should use skating equipment, or classic skis waxed for skating (glide wax tip to tail) with skating poles.

Key Teaching Points:

- Use the opportunity for one-on-one technique instruction.
- Encourage the skiers to experiment and practise the turns on their own. Set various courses to ensure different turns in different situations will be practised. Add natural bumps and hollows to the courses where practical.
- Snowplow Turn**
 - ✓ Maintains Snowplow wedge.
 - ✓ Changes direction, left and right.
 - ✓ Skier completes three turns on each side, under control.
 - ✓ Poles are not planted.
 - ✓ Pole tips behind body, pole handles in front of body.
 - ✓ Safety stops at the bottom of the hill.
 - ✓ Common errors:
 - skier has difficulty in turning in one direction.
 - one or both hands are beside or behind hips.
 - skier makes wedge but is not in control.

Teaching Aids Needed:

- Select a hill that has a suitable gradient for the skill level of the group. Arrange grooming for a large enough area that all of the group can be active at the same time. If conditions are icy, switch this practice plan for a different one, and try the downhill maneuvers on another day.
- Cones or other markers; coloured sticks.
- Help from parents and other coaches.
- Tall ski poles and colored ribbon or surveyors' tape.





Skill	Description	Time
<p>Ski Play (to warm up)</p>	<p>Varied speeds.</p>	<p>5 min.</p>
<p>Downhill Games</p>	<p>Pick-up Sticks: Skiers start at bottom of a hill. They ski up the hill using the technique of choice, and then Free Glide down the hill. Parallel to the tracks going down the hill there are sticks lying flat on the snow. As the skiers come down the hill they try to pick up three sticks. Repeat.</p> <p>Roller Coaster Bumps: Add one or two bumps on the downhill for the skiers to go over or jump off of. Begin initially with picking up one stick on the run down, increase that number to two sticks, and three sticks if the skiers can manage it.</p> <p>Bicycle Bumps: Use crossed ski poles to set up a series of archways on a long gentle slope (two poles per archway). Set up an archway every five or six metres. Place a single pole angled into the snow, between the arches and tie a ribbon to the top of it. To play the game, the skiers bend down when going under the arch, and reach up to touch the ribbon on the pole between the arches. Increase the challenge, allow the skiers to increase their speed, or shorten the distance between the poles.</p>  <p>The diagram shows a skier at the bottom of a slope, moving upwards through a series of archways. Each archway is formed by two crossed ski poles. A single pole is placed between the arches, angled into the snow, with a ribbon tied to its top. The skier is shown in a crouched position, reaching up to touch the ribbon between the arches.</p>	<p>30 min</p>

Figure 5.11





	<p>Human Slalom: Have the skiers break into small groups of three or four. Each group moves to a different location, and stands several metres apart, in a line, going down a long hill. The skier at the top slaloms down the hill, moving around the other skiers in the group. They stop a few metres after the final skier in the line. The next skier at the top of the hill slaloms then through the line of skiers and stops a few metres beyond the final skier in the line. This continues until all the skiers are at the bottom of the hill.</p>	
<p>Snowplow Turn (Review and introduce)</p>	<ol style="list-style-type: none">1) Coach demonstrates and reviews key points.2) Skiers Snowplow straight down the slope, increasing and decreasing the size of the wedge.3) Skiers alternate from straight running, to plowing, to straight running, on the way down the hill.4) Skiers Snowplow and edge one ski more than the other until they turn sideways on the hill and stop. Repeat several times in both directions.5) Skiers Snowplow and edge one ski more until they turn, but they continue to go downhill.6) Repeat several times.7) Link Snowplow Turns.	<p>10 min.</p>



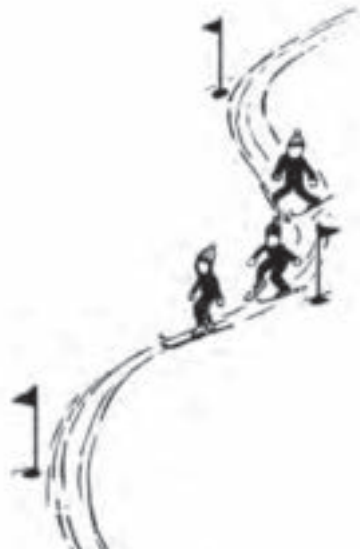

<p>Downhill Games</p>	<p>Snowplow with Poles: The coach sets up a slalom course on the hill as per the diagram. Poles are staggered three/four metres apart. The distance between two poles on the same side would be about five metres. Skiers ski down the hill to the inside of each pole and reach out and try to touch the pole as they go by.</p>  <p>Figure 5.12</p>	<p>30 min.</p>
<p>Ski Play</p>	<p>Skiers use the ski playground under the supervision of the coaches. Coaches provide one-on-one instruction.</p>	<p>20 min.</p>
<p>Wrap Up (in day lodge)</p>	<p>Conclude the session with hot chocolate, and a short social time at the day lodge.</p>	<p>15 min.</p>





PRACTICE PLAN 30 (LEVEL 4 – ON SNOW)

BACKWOODS ADVENTURE

Specific Objectives:

- 1) Introduce the skier to nature in winter.
- 2) Teach the skier how to prepare for a “long” tour in the woods.
- 3) Practise techniques learned during regular practice sessions.
- 4) Have FUN!

Note: Skiers will require equipment for classic technique.

This activity should take place on a ski trail that is new to the skiers and has a “backwoods” feel. The challenge should be more advanced than the backwoods tour offered in the Level 3 program; however it does not need to be far from the main ski trails to be an adventure.

This is an opportunity for the group to explore and experience nature in winter. Ideally, there will be a cabin somewhere along the route where the group can stop and rest, build a fire and have lunch.

Care should be taken that all skiers arrive at the destination at the same time. Keep the distance achievable and appropriate for the age and skill level of the skiers. For the skiers, the amount of time on skis should not be more than 1.5 hours in total.

Encourage the skiers to follow their route on a map.

Things to Bring:

- Equipment repair kit.
- First aid kit.
- Compass, maps.
- Food, water.
- Spare clothing and blankets as necessary.
- Matches.
- Extra wax.
- Refer to section 5.7 (Nature and Environment) for ideas that may be appropriate to include in this activity.





PRACTICE PLAN 31 (LEVEL 4 – ON SNOW)

Specific Objectives:

- 1) Develop and improve the skier's balance and agility.
- 2) Review and introduce Diagonal Stride and Uphill Diagonal Stride with glide.
- 3) Review One-step Double Poling.
- 4) Review Parallel Side Slipping.
- 5) Review Step Turn

Note: Skiers will require ski equipment for classic technique.

Key Teaching Points:

Diagonal Stride

- ✓ Emphasize that hands are forward at shoulder height.
- ✓ Emphasize that pole plant is beside the lead foot with arms slightly bent.
- ✓ Common errors:
 - poles are planted upright.
 - hands are raised well above shoulder height before planting.

Uphill Diagonal Stride (with Glide)

- ✓ A little glide should be visible.
- ✓ Skier maintains a slightly forward upper body lean.
- ✓ Skier has a distinct weight shift.
- ✓ When planting poles, hands are forward at shoulder height, and each pole tip is planted beside or behind opposite lead foot (left pole is planted beside right foot when right foot is leading).
- ✓ Pole plant should be consistent.
- ✓ Full extension of arms and legs.
- ✓ Common errors:
 - as hill becomes steeper, skier leans forward more as opposed to becoming more upright.
 - skier starts walking and keeps weight in between the two skis.
 - skier does not adjust timing by kicking a little earlier.

Teaching Aids Needed:

- Sufficient parallel sets of tracks to play Scooter games.
- Help from parents and other coaches.





Cones or other markers.

Skill	Description	Time
Ski Play (to warm up)	Varied speeds.	5 min.
Balance and Agility	Quick Thinking: This game tests the skiers' ability to move quickly and maintain balance. The coach stands in front of the group and points in different directions (forward, backward, side-ways). The group responds accordingly. In addition to pointing directions, the coach can call out directions as well. If two skiers collide, they are eliminated from the game. Another variation is to arrange the skiers in a large circle. The coach then calls out "hop left", "slide right", "jump left", etc. No poles.	5 min.
Diagonal Stride (Review and introduce)	<ol style="list-style-type: none">1) Coach demonstrates and reviews key points.2) Skiers practise the skill, with an emphasis on kick starting early.3) Skiers practise arms only Diagonal Stride (for a couple of minutes only).4) Skiers keep their legs rigid, lean forward at approximately 45 degrees, and pole diagonally.5) Repeat, with an emphasis on full extension of arms past hips.6) Repeat, with an emphasis on proper pole plant.7) Practise this skill while skiing out on a ski trail.	10 min.





<p>Uphill Diagonal Stride (with glide) (Introduce)</p>	<ol style="list-style-type: none"> 1) Coach demonstrates and reviews key points. 2) Skiers practise the skill with a more upright position – there is still a slight forward lean. 3) As the glide becomes shorter, the pole plant occurs further back behind the lead foot. <p>Stop and Go: Have skiers stop completely on the hill, and stay in the tracks. Then have them restart.</p> <p>Uphill Runner: Have skiers run on their skis uphill, and then switch to gliding.</p>	<p>10 min.</p>
<p>Game Time</p>	<p>Glide and Slide: Prepare a circuit with a tracked uphill where the skiers can Diagonal Stride at least half way up, and a downhill where the skiers can make use of different downhill techniques. For each skier, set individual markers on the uphill tracks to indicate how far he/she can diagonal up with glide. The next time around the circuit, have skiers try to beat their marks.</p>	<p>15 min.</p>
<p>Parallel Side Slipping (Review)</p>	<ol style="list-style-type: none"> 1) Coach or role model demonstrates and reviews key points. 2) Skiers practise sliding and edging their skis. <p>Red Light, Green Light: The coach is the policeman, and is positioned at the top of the hill. The skiers are positioned along a start line on the slope near the top of the hill. When the policeman says “green light” the skiers begin Side Slipping down the hill. When the policeman says “red light” the skiers stop. When caught moving on a red light, skiers have to sidestep back to the start line at the top of the hill. The game ends when the first skier crosses the finish line at the bottom of the hill.</p> <ol style="list-style-type: none"> 3) As skills become more proficient, move the skiers to areas that have bumps and hollows. 4) Following the game, have skiers Side Slip two metres and stop; redirect skis slightly downhill; Snowplow Turn, Side Slip in other direction. 5) Repeat. 	<p>10 min.</p>





Step Turn	Coach demonstrates and reviews key points. Skiers practice the skill.	5 min.
Game Time	<p>Steal the Pole: Two concentric rings of ski poles are formed (inner ring – six metres; outer ring – nine metres), where the outer ring has one less pole than the number of skiers. The skiers ski around within the inner circle until the coach signals to them to dash for one of the ski poles that make up the outer circle.</p> <p>The skier that ends up without a pole is sent outside the outer circle and a second pole is removed. Those who were able to get a pole go back to skiing in the inner circle, and the skier who did not get a pole skis around the outside of the outer circle. At a signal from the coach, all the skiers try to reach a pole. Assuming that the skier on the outside can reach a pole before those inside the circle, there will be two skiers from inside the circle that won't reach a pole. These two then ski around the outside and those who did reach a pole continue to ski within the inner circle. Continue removing poles until the game ends.</p>	15 min.
Explore a Ski Trail	Skiers explore a designated trail under the supervision of the coaches. The coaches provide some one-on-one technique instruction.	20 min.
Wrap Up (in day lodge)	Conclude the session with hot chocolate, snacks and a short social time.	15 min.





PRACTICE PLAN 32 (LEVEL 4 – ON SNOW)

MINI-OLYMPICS

Participation in a modified ski tournament or other team building, semi-competitive activity such as an inter-school tournament or a mini-Olympics will introduce your group to new activities on skis. If you are fortunate, your club will organize special activities periodically, and all you will be responsible for is bringing your team. If not, refer to section 5.5 of the Introduction to Community Coaching Reference Material or section 8.3 of this manual and create a “special activity” of your own.

Specific Objectives:

- 1) Introduce skiers to a new type of cross-country ski experience.
- 2) Practice skills learned during regular practice sessions.
- 3) Have FUN!

Key Teaching Points:

- Plan for the activity and, if necessary, prepare the setting ahead of time.
- Provide suitable coaching support for the activity that has been selected.
- No formal ski instruction.
- Use opportunities for one-on-one technique instruction.

Teaching Aids Needed:

- Extra help from parents and other coaches.
- Depends on the activity.





PRACTICE PLAN 33 (LEVEL 4 – ON SNOW)

Specific Objectives:

- 1) Develop and improve the skier's balance and agility.
- 2) Develop and improve One Skate.
- 3) Review and introduce Two Skate.
- 4) Introduce Offset.

Note: Skiers will require ski equipment for skating technique.

Key Teaching Points:

❑ Two Skate

- ✓ Emphasize that the upper body bends while poling.
- ✓ Emphasize hips and same side shoulders should be aligned over the gliding ski.
- ✓ Common errors:
 - poling with arms only.
 - centre of gravity remains mainly in the middle of the track.

❑ Offset

- ✓ Skier places the right ski on an angle, and both poles (Double Poling motion) on the snow at the same time.
- ✓ The ski is placed on the snow with the knee in front of the ankle, and the right shoulder and hip aligned over the right ski.
- ✓ During the Double Poling action, the right ski is edged, and the leg pushes off so the weight is transferred onto the left ski, with the knee in front of the ankle.
- ✓ The skier balances briefly with the left shoulder and hip aligned over the left ski; the ski is edged; the left leg pushes off to transfer the body weight onto the right ski and the start of a new poling action.
- ✓ The skier never stops gliding.
- ✓ Pole plant occurs at the same time, but hand position is offset; the high arm pole is planted with a slight slant and the hand is between the shoulders and top of head; the low arm pole is planted with a big slant, with hand position in front of the chest.
- ✓ Weight is transferred quickly and does not linger over the ski as it does in One Skate and Two Skate.
- ✓ Common errors:
 - timing: when skiers learn One and Two Skate first, they tend to use Two Skate timing when they try Offset. If they are introduced to Offset first, they tend to use Offset timing when learning Two Skate.





- there is an incomplete weight shift.
- elbows straighten in poling before they get to hips.
- -skis stop gliding before weight shifts off them.
- skiers sit back.
- skiers don't use trunk flexion when poling.
- low arm pole plants first, then ski, then high hand pole.

Teaching Aids Needed:

- Help from parents and other coaches.
- Cones or other markers.
- Enough old hockey sticks for each skier in the group; a soft ball; a soccer-sized coloured play ball.

Skill	Description	Time
<p style="text-align: center;">Ski Play (to warm up)</p>	<p style="text-align: center;">Varied speeds.</p>	<p style="text-align: center;">5 min.</p>
<p style="text-align: center;">Balance and Agility</p>	<ol style="list-style-type: none"> 1) Skiers stand in place with skis in a "V" position. 2) Skiers balance on one ski, and touch the other ski with their hand. 3) Next the skiers balance on the other ski and touch the first ski with their hand. 4) Skiers edge the inside of one ski and then the other. 5) Repeat several times, occasionally edging both skis at the same time. 6) Skiers edge skis and sidestep. 7) Skiers sidestep or hop sideways as far as they can to see who can make the biggest mark in the snow when pushing off. Repeat several times and then reverse direction. 8) Skiers sidestep or hop sideways and slightly forward as far as they can. Emphasize turning the body in the direction of the hop and gliding after the hop. 	<p style="text-align: center;">5 min.</p>





Game Time	Ball Tag: The coach identifies one skier as “It”. “It” tags the other skiers by hitting them with a soft ball. If one of the skiers catches the ball without the ball hitting the ground, the thrower (“It”) has to ski a small 100 metre circuit before he/she can return to the game. Variation: use more than one ball and more than one “It” – about a third of the skiers could be “It”. No poles.	10 min.
One Skate (Review)	1) Coach demonstrates and reviews key points. Double Double Skate: Skiers pole with toes, knees, hips, body and shoulders aligned in the direction of the gliding ski for the first double pole. The skiers pole again on the same side. Half way through the second poling, weight is transferred and leg pushes off ski. 2) Emphasize long glide, under control. 3) Return to normal One Skate, emphasizing that Double Poling starts in the direction of the gliding ski. 4) Emphasize ankle and knee flexion on push off. 5) Emphasize pushing to side and not back.	10 min.
Game Time	Snow Hockey: Use old hockey sticks (floor hockey or ball hockey, with plastic blades preferable), and soccer-sized coloured play ball. Coaches and parents need to closely monitor the safe use of the sticks.	10 min.





<p>Two Skate (Review and introduce)</p>	<ol style="list-style-type: none"> 1) Coach demonstrates and reviews key points. 2) Skiers begin with a One Skate, then Double Pole. 3) When the skiers transfer their weight, they should be finishing their arm push. 4) During the weight transfer to the original ski, the skiers drive the arms forward to Double Pole 5) Emphasize weight transfer on both skis. 6) Emphasize that the upper body bends during Double Poling. 	<p>10 min.</p>
<p>Offset (Introduce)</p>	<p>Coach (or role model) demonstrates and reviews key points. For more information refer to section 4.3.7 of this manual.</p>	<p>15 min.</p>
<p>Game Time</p>	<p>Spud: Each skier is given a number from one to ten. The coach throws a ball high as possible, calling out a number up to ten. All the skiers scatter except the skier whose number was called (the “ball catcher”). The “ball catcher” attempts to catch the ball. Once the “ball catcher” catches the ball, he/she yells out “stop” and all other skiers must stop. If the “ball catcher” catches the ball without it hitting the ground, the other skiers automatically earn three “strides”. The “ball catcher” tries to hit one of the skiers with the ball (who may now use the three strides if they earned them). The skiers are allowed to bend to dodge the ball but must not move their skis. If skiers get hit, they have to take a letter from the word Spud, and then they have to hit one of their team mates with the ball. If they miss, they have to take another letter from the word Spud, and try again to hit one of their team mates. No poles.</p>	<p>10 min.</p>
<p>Ski Play</p>	<p>Skiers use the ski playground under the supervision of the coaches. Coaches provide one-on-one instruction.</p>	<p>20 min.</p>





<p>Wrap Up (in day lodge)</p>	<p>Conclude the session with hot chocolate, snacks and a short social time.</p>	<p>15 min.</p>
--	---	----------------





PRACTICE PLAN 34 (LEVEL 4 – ON SNOW)

Specific Objectives:

- 1) Develop and improve the skier's balance and agility.
- 2) Review Diagonal Stride.
- 3) Review Parallel Side Slipping.
- 4) Review Free Glide and High and Low Tuck.

Teaching Aids Needed:

- Sufficient parallel sets of tracks to play Scooter games.
- Help from parents and other coaches.
- Cones or other markers.

Skill	Description	Time
Ski Play (to warm up)	Varied speeds	5 min.
Balance and Agility	Scooter Cops and Robbers: Everyone has only one ski on. One coach is the "cop". The skiers are "robbers". The robbers are safe as long as they are in a marked area (hideout). However they cannot stay in the hideout for more than five seconds. One of the marked areas is a prison. When robbers are tagged by a cop, they must go to prison. When captured robbers are tagged by a free robber, they can go free. Switch skis to opposite foot after five minutes.	10 min.





Diagonal Stride (Review)	1) Coach demonstrates and reviews key points. 2) Skiers practise the skill with an emphasis on kick starting early. Measured Scooter: Mark off one track every 0.75 metres. Mark other tracks at 1 metre, 1.25 metre and 1.5 metre intervals. Have the skiers start in the first track. If they continually glide past each marker, they move to the next track, etc.	10 min.
	3) Repeat using Diagonal Stride with poles. 4) Emphasize recovery foot beside or in front. 5) Emphasize forward lean, keeping hips forward. 6) Next practise “arms only diagonal”. Keeping legs rigid, skiers stand upright and diagonally pole down the track. Repeat, leaning forward at an approximately 45 degree angle. Have the skiers think about which position is faster (leaning forward should be). 7) Repeat with a full extension of arms past hips. 8) Diagonal Stride with arms and legs back in the marked tracks again.	
Game Time	Glide and Slide: Prepare a circuit with a tracked uphill where the skiers can Diagonal Stride at least half way up, and a downhill where the skiers can make use of different downhill techniques. For each skier, set individual markers on the uphill tracks to indicate how far he/she can diagonal up with glide. The next time around the circuit, the skier tries to beat their mark.	15 min.





<p>Parallel Side Slipping (Review)</p>	<ol style="list-style-type: none"> 1) Coach or role model demonstrates and reviews key points. <p>Red Light, Green Light: The coach is the policeman, and is positioned at the top of the hill. The skiers are positioned along a start line on the slope near the top of the hill. When the policeman says “green light” the skiers begin Side Slipping down the hill. When the policeman says “red light” the skiers stop. When caught moving on a red light, skiers have to sidestep back to the start line at the top of the hill. The game ends when the first skier crosses the finish line at the bottom of the hill.</p> <ol style="list-style-type: none"> 2) As skills become more proficient, move the skiers to areas that have bumps and hollows. 3) Following the game, have skiers side slip two metres and stop; redirect skis slightly downhill; Snowplow Turn, side slip in other direction. 4) Repeat. 	<p>10 min.</p>
<p>Free Glide – High and Low Tuck (Review)</p>	<ol style="list-style-type: none"> 1) Coach demonstrates and reviews key points. 2) Skiers practise Free Glide on a steeper slope than used previously. 3) Coach or role model demonstrates and reviews key points. 4) Skiers Free Glide with an emphasis on hands forward and knees bent. 5) Begin with a High Tuck, then a Low Tuck. 6) Switch from one to the other on the same run down the hill. <p>Streamers: Place two different coloured streamers or surveyors’ tapes above the tracks. The streamers should be at a height that would just touch the back of a skier in a High Tuck. Skiers go down the hill in a Low Tuck staying below the streamers. Then they ski down the hill in a High Tuck, touching the streamers with their back, but not their head. The next step is for the skiers to do one colour in a High Tuck and the other in a Low Tuck. The streamers must be set up in such a way that they do not pose any danger to the skiers.</p>	<p>10 min.</p>





Game Time	Crows and Cranes. Divide the group into two teams: “Crows” and “Cranes”. Use a crepe paper flag, or have all of one team wear toques. On a signal, the entire group scatters over the playing area. On a signal from a whistle, the skiers freeze where they are. The leader now calls either “Crows” or “Cranes”. The team called is chased by the other team - e.g. if “Crows” is called, the “Cranes” chase the “Crows”. If caught, a Crow becomes a Crane. Freeze, chase, freeze, chase and so on, until one team is absorbed.	15 min.
Explore a Ski Trail	Skiers explore a designated trail under the supervision of the coaches. The coaches provide some one-on-one technique instruction.	20 min.
Wrap Up (in day lodge)	Conclude the session with hot chocolate, snacks and a short social time.	15 min.





PRACTICE PLAN 35 (LEVEL 4 – ON SNOW)

SKI RACE

The purpose of this activity is to introduce young skiers to a traditional cross-country ski competition. This could be a formal inter-club competition, or it could be organized by your club/group to simulate a real event in order to teach race rules and procedures. A formal competition is strongly recommended because it is much more exciting for the skiers and it provides an opportunity for the group to meet new ski friends.

Specific Objectives:

- 1) Have the participants involved in a special motivational activity.
- 2) Have the skier meet new ski friends.
- 3) Have the skier learn new sport skills.
- 4) Develop and improve the skier's balance and agility.

Key Teaching Points:

- Emphasize team work.
- Encourage and praise each child for taking part in and completing the task.
- Downplay winning, and emphasize an effective exchange, good technique and sportsmanship.
- Teach skiers the relevant rules and procedures:
 - ✓ Start procedures.
 - ✓ Tracking skiers on the course.
- Ski the course with the skiers prior to the race.
- Use the opportunity for one-on-one skill instruction.

Teaching Aids Needed:

- Refer to section 8 of this manual for tips on coaching a group at a competition.
- A wax box.
- Extra help from parents and other coaches (including transportation to and from the event).
- CCC Rules and Regulations.



**PRACTICE PLAN 36 (LEVEL 4 – ON SNOW)****Specific Objectives:**

- 1) Develop and improve the skier's balance and agility.
- 2) Review One Skate.
- 3) Review Two Skate.
- 4) Review and introduce Offset

Note: Skiers will require ski equipment for skating technique.

Key Teaching Points: **Offset**

- ✓ Emphasize transferring weight from ski to ski.
- ✓ Emphasize pushing sideways and not backwards.
- ✓ Emphasize faster turnover.
- ✓ Emphasize skis need to be moving at all times.
- ✓ Common errors:
 - centre of gravity stays mainly between skis.
 - skier glides too long (if they do they should be using one or Two Skate technique instead – body weight does not “linger” over glide ski as it does in One or Two Skate).
 - skis stop in snow – particularly on non-poling side.

Teaching Aids Needed:

- Help from parents and other coaches.
- Cones or other markers.

Skill	Description	Time
Ski Play (to warm up)	Varied speeds.	5 min.





<p>Balance and Agility</p>	<ol style="list-style-type: none"> 1) Skiers stand in place with skis in a “V” position. 2) Skiers balance on one ski, and touch the other ski with their hand. 3) Next the skiers balance on the other ski and touch the first ski with their hand. 	<p>5 min.</p>
	<ol style="list-style-type: none"> 4) Skiers edge the inside of one ski and then the other. 5) Repeat several times, occasionally edging both skis at the same time. 6) Skiers edge skis and sidestep. 7) Skiers sidestep or hop sideways as far as they can to see who can make the biggest mark in the snow when pushing off. Repeat several times and then reverse direction. 8) Skiers sidestep or hop sideways and slightly forward as far as they can. Emphasize turning the body in the direction of the hop and gliding after the hop. 	
<p>Game Time</p>	<p>Chain Tag: Establish a playing area with boundaries, with one skier as “It”. When “It” tags another skier, they hold hands and try and catch others. The skiers in the chain are not allowed to let go hands or move out of bounds, so the group must work cooperatively as the chain gets longer.</p>	<p>10 min.</p>
<p>One Skate (Review)</p>	<ol style="list-style-type: none"> 1) Coach demonstrates and reviews key points. Double Double Skate: Skiers pole with toes, knees, hips, body and shoulders aligned in the direction of the gliding ski on the first double pole. The skiers pole again on the same side. Half way through the second poling, weight is transferred and leg pushes off ski. 2) Emphasize long glide, under control. 3) Emphasize ankle and knee flexion on push off. 4) Emphasize pushing to side and not back. 	<p>10 min.</p>





Game Time	Towing Game: Use One Skate technique. A rope is tied to a belt or backpack frame that the skiers wear to pull objects around (toboggans, tires, etc.). Skiers may also pull each other around. If a skier is being towed, one or two large knots should be tied to the trailing end of the rope to make it easier to hang onto. At first the skier being towed should be in a tuck with skis as flat as possible.	10 min.
	If this is too easy for the pulling skier, additional skiers can hang onto the rope, or the skiers being pulled can Snowplow (after they start moving and there is some momentum). Emphasize to the pulling skier that they need to bend their ankles and knees to give a strong pull.	
Two Skate (Review)	<ol style="list-style-type: none">1) Coach demonstrates and reviews key points.2) Skiers practise the skill.	10 min.
Offset (Review and introduce)	<ol style="list-style-type: none">1) Coach demonstrates and reviews key points. One Pole Offset: Skiers use pole on poling side, take the other pole off. Emphasize good weight transfer. Emphasize push is sideways and not backwards. Emphasize ski comes off snow flat (not tail first). Switch pole to the other side and repeat.2) Next, using both poles, emphasize planting poles close to skis. Emphasize that elbows come to chest before straightening.	10 min.





<p>Game Time</p>	<p>This exercise should take place on one of the ski trails. Skating technique.</p> <p>Tracking: Coordinate skiers in a tightly packed, single-file line along the trail. Begin skiing. Every 30 seconds, the coach calls “Track” and the skier at the front of the line steps out of the way. This skier continues to ski (may have to Double Pole so as not to interfere), but at a slightly slower pace until the line of skiers goes by. The skier from the front of the line then jumps back into line at the end of the file of skiers.</p> <p>Pass: Continue the line of skiers as above, but change the command to “Pass”. In this game, the last person in line jumps out of the line and skis as fast as possible to the front of the line. In order for the last skier to pass the line of skiers, the coach may have to control the speed of the group by skiing in front. The “passing” skier then jumps back into the line behind the coach. Note this can be done on appropriate downhill sections as well.</p>	<p>30 min.</p>
<p>Wrap Up (in day lodge)</p>	<p>Conclude the session with hot chocolate, snacks and a short social time.</p>	<p>15 min.</p>





PRACTICE PLAN 37 (LEVEL 4 – ON SNOW)

SPRINT GAMES

Specific Objectives:

- 1) Introduce skiers to a speed “game” using skating technique.
- 2) Have FUN!
- 3) Determine annual Program Awards for sprints.

A classic technique sprint, followed by a skating technique sprint, is recommended for the Level 4 Sprint Games.

Refer to Practice Plan 11 - Level 2, Practice Plan 37 - Level 3 and section 8.3.3 for detailed information. Note some exceptions to the previous activities are listed below.

Key Teaching Points:

- Have the skiers go through the full routine for a classic technique sprint, increasing the expectations from the previous year.
- Have the skiers prepare for a skating technique sprint with help from coaches and parents.
- Have the skiers go through the full routine for a skating technique sprint, increasing the expectations from the previous year.
- Emphasize the comparison between a skier’s classic and skating “times”, as well as the “time” for the same distance/technique in previous years.

Tasks:

- Arrange ahead of time for two courses, one for a “skating” sprint event and one for a “classic” sprint event. If space does not allow for two courses, the classic tracks can be set down the centre of each of the four skating lanes.
- Explain the “rules” before each event - classic and skating.





PRACTICE PLAN 38 (LEVEL 4 – ON SNOW)

SKILL EVALUATION SESSION #1

Specific Objectives:

- 1) Review and evaluate each skier's ability to perform the One-step Double Poling, Step Turn and Parallel Side Slipping techniques against the Level 4 standard.
- 2) Provide one-on-one assistance and re-evaluate skiers whose skill level is below the Level 4 standard.
- 3) Conduct the assessment in an informal environment so that the skiers are not intimidated.

Note: Skiers will require classic equipment for this session.

Key Teaching Points:

- Plan the session so that areas with suitable terrain are available when needed, and the grooming is appropriate for this purpose.
- Coordinate the evaluation so that the skiers stay active.
- When evaluating skiers, the emphasis should be on the successful accomplishment of a skill. The standard should be achieved only if it is truly deserved.

Teaching Aids Needed:

- Extra help from parents and other coaches, including experienced colleagues who can assist with the evaluation.
- Clipboards and paper with plastic protection; pencils.
- Frame by frame video replay camera.
- “Skill Criteria and Evaluation Benchmarks - Level 4” (section 4.3.7) and “Skill Checklist - Level 4” (section 4.3.8), prepared ahead of time for finishing off the evaluations.

Skill	Description	Time
Ski Play (to warm up)	Varied speeds.	5 min.





Balance and Agility	<p>Flea Leaps: Skiers jump into the air (on their skis) and land softly in a balanced position.</p> <p>Rubber Leg: Skiers first stand tall on one leg/ ski and then relax it, letting it slump into a flexed position at the ankle and knee. Alternate legs.</p>	5 min.
Assess Level 4 Skills	<ol style="list-style-type: none">1) Coach demonstrates a technique.2) Skiers practise the technique while receiving on the spot feedback via video camera replay.3) Coach evaluates the skiers' skills and records their evaluation on the Skills Checklist.4) Assistance and re-assessment provided to skiers that did not meet the Level 4 standard (by experienced assistant coaches)	65 min.
Ski Play	Ski playground under the supervision of the coaches. Some one-on-one instruction in areas where skiers need improvement to meet the skill criteria.	20 min.
Wrap Up (in day lodge)	Remind the group to come prepared for skating technique at the next practice session. Conclude the session with hot chocolate, snacks and a short social time at the day lodge.	15 min.





PRACTICE PLAN 39 (LEVEL 4 – ON SNOW)

SKILL EVALUATION SESSION #2

Specific Objectives:

- 1) Review and evaluate each skier's ability to perform Free Skate, One Skate, Two Skate and Offset techniques against the Level 4 standard.
- 2) Provide one-on-one assistance to skiers whose skill level is below the Level 4 standard.
- 3) Conduct the assessment in an informal environment so that the skiers are not intimidated.

Note: Skiers will require skating equipment for this session. As a minimum, the skiers will require skating length poles and classic skis with glide wax from tip to tail (i.e. the grip wax removed from the grip zone).

Key Teaching Points:

- Plan the session so that areas with suitable terrain are available when needed, and the grooming is appropriate for this purpose.
- Coordinate the evaluation so that the skiers stay active.
- When evaluating skiers, the emphasis should be on the successful accomplishment of a skill. The standard should be achieved only if it is truly deserved.

Teaching Aids Needed:

- Extra help from parents or other coaches, including experienced colleagues who can assist with the evaluation.
- Clipboards and paper with plastic protection; pencils.
- Frame by frame video replay camera.
- "Skill Checklist" (section 4.3.8) prepared ahead of time for finishing off the evaluations.
- "Skill Criteria and Evaluation Benchmarks - Level 4" (section 4.3.7).

Skill	Description	Time
Ski Play (to warm up)	Varied speeds.	5 min.





Balance	Snakes: The skiers follow the coach, who leads the group through the ski playground, changing directions frequently, going over or around obstacles and using different terrain. The coach might also include different skills such as Step Turn, Offset, and Kick Turn.	10 min.
Assess Level 4 Skills	<ol style="list-style-type: none">1) Coach demonstrates a technique.2) Skiers practise the technique while receiving on the spot feedback via video camera replay.3) Coach evaluates the skiers' skills and records their evaluation on the Skills Checklist.4) Assistance and re-assessment provided to skiers that did not meet the Level 4 standard (by experienced assistant coaches)	60 min.
Ski Play	Ski playground under the supervision of the coaches. Some one-on-one instruction in areas where skiers need improvement to meet the skill criteria.	20 min.
Wrap Up (in day lodge)	Conclude the session with hot chocolate, snacks and a short social time at the day lodge.	15 min.





PRACTICE PLAN 40 (LEVEL 4 – ON SNOW)

YEAR END ACTIVITY

Specific Objectives:

- 1) Provide a fun finale to the season's activities.
- 2) Encourage teamwork through adventurous, cooperative activities.
- 3) Further develop the skier's cross-country ski skills.
- 4) Recognize enthusiasm, effort, skill achievement and respect for others.

Teaching Aids Needed:

- Technique and Program Awards, Progress Reports.
- This depends entirely on the activities that are used.
- Refer to sections 4.3 and 5.5 of the Introduction to Community Coach Reference Material, and sections 4.3.9 and 8.3.3 of this manual for a selection of suitable activities.





5.7 Nature and Environment

One of the objectives of CCC's skill development programs is to raise awareness and educate children with respect to nature and the environment. With a little creativity, educational information of this kind can be incorporated into practice sessions in ways that appear seamless. For example, the information on animal tracks can be smoothly integrated with the Orienteering Poker Ski game outlined in section 5.5 (Practice Plan 35); and information on the properties of snow can be introduced during a Backwoods Adventure as in section 5.4 (Practice Plan 14), section 5.5 (Practice Plan 30) and section 5.6 (Practice Plan 30).

Snow Crystals and Snowflakes

Snowflake observation will be of interest to your group and will provide your skiers with a better appreciation of nature as well as a better understanding of how waxes work. You may require a magnifying glass for this activity, as snow crystals are typically quite small.

Interesting Facts:

- Snow crystal** - a single crystal of ice. The classic snow crystal has six-fold symmetry due to the crystalline nature of ice. On occasion this can be twelve-fold symmetry if two six-branched crystals form and grow together. Snow flakes/crystals never develop with five-fold (or other) symmetry.
- Snowflake** - a more general term that can apply to either single or multiple snow crystals.
- Snow crystals form in the clouds, typically on a minute dust particle, when water vapor condenses directly into ice. The elaborate patterns of a snowflake form as the crystal grows. Snow crystals stay and grow in the clouds until they become too heavy, or, for other reasons, fall out of the clouds.
- Sleet** – a frozen raindrop (snowflakes are not frozen raindrops).
- The biggest influence on snowflake structure is temperature. Different types of snowflakes are formed as a result of different temperatures and different humidity.
- On cold days small, flatter snowflakes are formed with a flatter crystal structure.
- As the temperatures and humidity rise, larger snowflakes, with many-sided branches, are formed. As temperatures increase, the snow crystal takes on more of a six-sided columnar (or needles-like) shape, rather than the classic snowflake form.
- Fluctuations in temperature and humidity as well as bouncing around in the clouds can further influence the development of snow crystals.
- As fallen snow “ages” it undergoes a transformation. The points of the snow crystals begin to wear down and the snow becomes more compact. At first, when the points of the snow crystal are sharp, a harder wax can be used because the points stick into the wax easily. As the snow ages and the snow crystals become more rounded, a softer, stickier wax is required in order to get grip.

More information on snowflakes can be found on the internet.





Animal Tracks

Animals that skiers share the forest with during the winter season will vary from one region of Canada to another. Below is a description of some animals that are found in one region. To ensure the animals you identify for your activities actually represent the wildlife in your area may require some additional research on your part.



- ❑ **Lynx:** The elusive lynx is a specialized snow-belt cat with large fur-covered paws that are well adapted for travel in deep snow. Lynxes hunt by stealth, by ambush and by slow, careful stalking. Their usual hunting method is to sit patiently beside a snowshoe hare trail waiting for a hare to race by. Once they capture prey, they'll often build a snow cover or shelter over uneaten portions to protect it from other predators.

Distinguish lynx tracks from canine tracks (wolves, coyotes, foxes) by noting the round shape of the track and the absence of claw marks in the snow; the claws are drawn up into the toe pads when the animal is running or walking.



- ❑ **Moose:** Notice a series of large holes along the ski trails? These are the tracks of moose, the largest member of the deer family. In the winter, moose feed on the twigs of shrubs and trees. Each moose eats 10-20 kilograms of twigs every day. Red-osier dogwood and highbush-cranberry are their favorite foods. Twig ends browsed by moose have a ragged, ripped appearance because moose don't have upper incisors (in contrast to snowshoe hares which leave a clean cut when they browse). Small mammals that feed on conifer seeds help moose by keeping down the conifers that would crowd-out good moose food. Due to their large size, healthy moose have few predators except wolves that can hunt bulls, cows and calves during the winter months.

The neat pattern of alternating large holes you see along the ski trails are the tracks of moose.



- ❑ **Spruce Grouse:** Listen for the loud fluttering of wings and look carefully for a brown, chicken-like bird perched on a branch close to the trunk of a tree. Protectively coloured adults will often "freeze" in the trees leading to the name "fool hen". In winter, this species browses only in conifer trees requiring its gastrointestinal tract to increase in size to digest conifer foliage. Look for the three-toed pattern or chain of grouse tracks in the snow between the trees. The main predator of this forest-dwelling grouse species is the Northern Goshawk.

Look for the three-toed pattern or chain of grouse tracks in the snow between the trees.





- ❑ **Marten:** This species has golden brown fur and is often seen sitting on tree branches or stumps. It hunts in trees for squirrels and on the ground for small rodents, especially red-backed voles. Marten are very active during the winter, investigating rock crevices, debris piles and subnivean entrances beneath the snow.

The most common marten trail is the 2x2 loping pattern with hind prints registering over the fore prints. Palm and heel pads are rarely seen. Although they have five toes, only four show in the tracks.



- ❑ **Red Squirrel:** Red squirrels are noisy, feisty, energetic and protective. It is not uncommon to see a squirrel scolding and chasing intruders that wander into its territory (this includes you!). A food cache is stored on the ground under tree roots and inside crevices and holes to form large middens, which are easily identified by the large piles of cone scales and shafts nearby. On sunny warm days during the winter, squirrels will nip off terminal buds and search for cones on conifer trees, while on miserable days they will rely on their cached cones or look for small piles of cone bracts on stumps or logs. In an odd display of generosity, female red squirrels sometimes give their territories and middens to their young.

When a red squirrel hops, its smaller front feet land first with the larger hind feet landing in front of them.



- ❑ **Otter:** The weasel family is a diverse group of carnivores comprising small weasels like the least weasel and short-tailed weasel, as well as larger species like the marten, river otter and wolverine. The otter species spends most of its time in the water looking for fish, but it also goes ashore and can travel great distances overland. Otters are often seen in groups consisting of a female and young or a group of males of various ages. While beavers create a large amount of otter habitat (ponds, lodges and burrows), otters repay them by tunneling through beaver dams so that they can move between ponds and streams under the ice.

River otters have many trail patterns but the most common in winter is the slide. Look for a few bounding steps and then a long belly slide (nearly 30 cm wide) leading straight down a hill into the water.





- ❑ **Porcupine:** In winter, porcupines can be found perched high in conifer trees, slowly chewing on the bark. For signs of their whereabouts, look for porcupine quills on trails or at the bases of the trees frequented by these animals. Another sign of their presence is trees with large square/rectangular bare patches filled with running sap. Porcupines will taste-test trees resulting in many small patches at variable heights on one tree. The main predator of this large prickly rodent is the fisher, who will climb high into the tree, pull the porcupine from its perch and then flip it over to expose its quill-free tummy.

In deep snow, the short-legged porcupine turns into a snowplow, making a deep trail with the hind prints registering on or just in front of the fore prints. Look carefully at the trail drag and you will see tiny lines made by the quills.



- ❑ **Snowshoe Hare:** Snowshoe hares have large feet with fur between the toes to enable them to hop across the snow in winter so they can browse on twigs and bark. Their fur changes from white to brown in summer (hence their other common name – the Varying Hare). The main predator in winter is the lynx, but surprisingly the main predator of very young hares (those less than ten days old) is the red squirrel.

The characteristic “Y” pattern of the snowshoe hare shows two small fore prints, one in front of the other, and two large hind prints (side by side) ahead of the fore prints.



- ❑ **Small Mammals:** Small mammals like mice, voles and shrews are active during the winter beneath the snow (subnivean area). Watch for them emerging from their tunnel entrances in the snow and racing across the trail in front of you. Forest dwelling carnivores like owls and weasels are well adapted to hunt these species in winter. Owls use their sensitive hearing to detect small mammals beneath the snow, while weasels use their small size to tunnel under the snow and follow their prey (look for a tunnel entrance near a stump or log).
- ✓ **Deer Mouse:** The bounding tracks of a deer mouse in soft snow will show hind and fore prints merging together to form larger pairs of prints, with a tail drag between them.





- ✓ **Meadow Vole:** The bounding tracks of a vole show prints in pairs, with the hind foot registering on top of the fore print.
- ✓ **Common Shrew:** Look for the small trail pattern of a shrew with the larger, widely spread hind prints preceding the fore prints, and a trail drag following behind.





REFERENCES

Saar, P. Practice Plans. CCBC Ski League Manual, 2000, pp. 43-147.

Orienteering Poker Ski and Nature and Environment – Animal Tracks. Bulkley Valley Cross Country Ski Club.

Lamb, J. Ski Play, Ottawa. Ski Jumping Canada, 1984.

Gullion, L. Ski Games. Champaign, Illinois. Leisure Press, 1990.



SECTION 6 - PREPARING FOR YOUR PRACTICE COACHING SESSION



Coaching Tip: Practice doesn't make perfect - practice makes permanent.
Only perfect practice makes perfect permanently!

Source: NCCP Level 1 Coaching Theory Manual



This section on Preparing for Your Practice Coaching Session complements the information provided in section 7 of the Introduction to Community Coaching Reference Material, and is directed primarily at supporting you, as a developing coach, in your role working with children during the FUNdamentals stage of development.

This section is also intended to provide you with materials that will assist you if you choose to work with athletes in the Learning to Train stage, and to prepare you for the next step in the NCCP Coaching progression, the “Competition Coaching – Introduction” program.

6.1 Tips for Leading a Practice Session

The FUNdamentals stage is critical for learning skills. All basic technique skills, both classic and skating, should be learned by skiers before the end of this period of development. To achieve this requires well-planned and executed practice sessions. To assist you in delivering effective sessions, a checklist of tips for preparing/leading a practice session has been provided below:

- Begin with the checklist of important considerations in section 4.1.1. Successful coaching of the sport of cross-country skiing is highly dependent on appropriate pre-session preparations.
- Use the practice plan templates provided in section 5, and develop your own practice-specific plan (plus a backup plan for all outdoor sessions), taking into consideration the terrain you have to work with, the weather forecast, etc.
- Be prepared so that you have the option of being flexible.
- Determine in advance what teaching aids/equipment you will require, and have them ready ahead of time.
- Plan for the terrain you will need, where at the ski area you should hold the practice session, and how your group will practice each skill.
- Plan how you will explain and demonstrate each skill; select the main teaching points (two to three is a good number); use clear, concise instructions.
- Introduce skills using their correct names.
- Create progressions – complex tasks are often learned more easily when presented in steps.
- Keep in mind that the attention span of children is limited, especially in the cold.
- Keep the demonstrations and instructions in front of the group to a minimum – this step should take approximately 1.5 minutes.
- Detailed instruction and feedback should take place on a one-on-one basis while the group is working on a skill.





- Ensure that the participants can carry out basic movements before combining them with complex skills and manoeuvres.
- Choose games that reinforce skills learned during the practice session, and know where these games fit into the progressions.
- Plan how you will explain each game.
- Keep variety in the program; activities, games and locations should vary.
- Make good use of the time available.
- Arrange for an appropriate coach to skier ratio.
- Arrange for parent helpers to chart progress and assist with special activities when needed.
- Make corrections on an individual basis. Often those who are performing a task correctly will make unnecessary changes because of comments made to the group as a whole.
- Allow for variable learning speeds and individual differences.
- Always give feedback when a skier learns a skill; be positive and use variety.
- Keep in mind that learning is an individual challenge, and avoid comparisons unless they serve as a reward for progressing to a new skill.
- Keep children active – they learn by skiing!

Tips for Evaluating Your Practice Session

- Was there a positive, FUN atmosphere?
- Did you speak at least once to each participant? If you missed someone, make a point of talking to them at the next practice.
- Were all the children active throughout the session?
- Did each child make some progress towards learning a new skill?



**Key Parts of a Complete Practice In Community Sport**

Time	Practice Part	Key Contents and Tips
variable 2-3 min	Introduction	 <p>Before practice begins:</p> <ul style="list-style-type: none"> ✓ Arrive early. ✓ Inspect/prepare facilities. ✓ Greet each participant as they arrive, get a feel for their preparedness – both clothing and equipment. <p>At the beginning of practice:</p> <ul style="list-style-type: none"> ✓ Start on time. ✓ Ask participants to gather in front of you. ✓ Talk briefly about the goals of the practice. ✓ Give specific safety instructions. ✓ End with a team cheer.
5 min 5-10min	Warm-up Motor Skills	<p>Ski play to raise body temperature.</p> <p>Short activities/games that build overall motor skills.</p> <p>Never skip a warm-up. Develop a routine and build good habits.</p>
25 min 10 min	Main Part Game	<p>Sequence three or more exercises/activities together in a progressive fashion:</p> <ul style="list-style-type: none"> ✓ Use cooperative exercises/activities whenever possible. ✓ Avoid elimination activities, because participants who need the most practice get eliminated first (e.g. if you lose the ball you are out). ✓ If parent assistants are available, set up stations to minimize downtime and line-ups. <p>Play games that reinforce the techniques taught during the main session:</p> <ul style="list-style-type: none"> ✓ Use mini-competitions; participants like to “play” the sport!
20 min	Ski Play	<p>Play time on skis under supervision. Provide some one-on-one technique instruction.</p>
2-3 min	Conclusion	<ul style="list-style-type: none"> ✓ End with hot chocolate, snacks and a short social time at the Daylodge. ✓ Talk to each participant at least once during the practice session.





The Perfect Demonstration

A picture is worth a thousand words. This is so true in sport. Movement needs to be seen to be learned, with words used only as highlights. ***Planning a good demonstration is like planning a film!*** Here are the steps:

- 1) **Why the skill?** Name it! Then say simply and briefly how, where, and when it is used.
- 2) **Teaching Points.** Choose two to five teaching points to emphasize. Make up short, descriptive key words or phrases to highlight each.
- 3) **Teaching Aids.** Decide if an aid (a chart or video for example) would help. Use an aid only if it will add something important to the demonstration.
- 4) **Formation.** Design a formation so that everyone will see and hear the demonstration clearly. Ensure the athletes face away from distractions such as the sun, or other activities.
- 5) **View.** Decide on the best angle to show the skill - sideways, head on, from behind, or a mixture of these. A certain teaching point might fit best with a certain view!
- 6) **Demonstrator.** Choose someone who can perform the skill correctly at the athletes' present level. Be sure your demonstrator is willing!
- 7) **Repetitions.** Decide how many times you need to repeat the demonstration in order to cover all the points, but avoid confusion or boredom.
- 8) **Questions.** Make sure the athletes understand. Ask if they have any questions. Help the athletes recall the key words or phrases you used.

Three important tips to remember are:

- With younger or inexperienced athletes, use only one or two teaching points.
- The entire procedure should last about 70 seconds. Three minutes is the absolute maximum.
- Rehearse!!!





6.2 Self-Assessment Sheet

Practice Coaching #2: Skill Progression, Intervention and Communication

Criteria	Yes	No
Skill Progression		
The progression for skill development is appropriate for the age/ability of the participant		
Coach focuses on the appropriate key points for the skill to be developed		
Coach adjusts the activity for more advanced and less advanced abilities within the group		
Comments/suggestions:		
Intervention		
Coach scans the entire group constantly and intervenes with a variety of participants		
Coach looks for input/feedback from the participant		
Correction or reinforcement is clear and a visual is provided		
Correction or reinforcement is brief and participant returns quickly to activity		
Coach focuses on communicating <i>what to do</i> (not what NOT to do)		
Comments/suggestions:		
Communication		
Coach speaks in a calm tone of voice (i.e. does not yell at the participants)		
Coach uses language that the children can easily understand		





Coach refrains from the use of foul language		
Words and body language used in the correction or reinforcement are positive *		
When praise is given, it is specific, not general (e.g. “you are doing ___ well”, not “nice one!”)		
Criteria	Yes	No
Coach acts and speaks with enthusiasm *		
Comments/suggestions:		

*This looks like: Smiles; nods in the affirmative.

*This sounds like: Cheers; “Sally, you did ___ very well. Way to go!”; “Johnny, I see that you are improving at ___. Great job!”

*This feels like: “High fives;” safe pats on the back; a hand shake of congratulations (use these only if the child/youth is clearly comfortable with physical contact from you).

Counting Interventions During the Activity	Number
Duration of the activity in minutes (when participants are practicing, excluding explanation & demo)	
Total number of interventions with the entire group	
Total number of interventions with individual participants	
Total number of different participants with whom the coach intervened	

Remember, more is not necessarily better. The total numbers are only to give you an indication of how often you are intervening and whether you are moving among the group or focussing only on certain participants.



**Self-Assessment Sheet****Practice Coaching #2: Skill Progression, Intervention and Communication**

Criteria	Yes	No
Skill Progression		
The progression for skill development is appropriate for the age/ability of the participant		
Coach focuses on the appropriate key points for the skill to be developed		
Coach adjusts the activity for more advanced and less advanced abilities within the group		
Comments/suggestions:		
Intervention		
Coach scans the entire group constantly and intervenes with a variety of participants		
Coach looks for input/feedback from the participant		
Correction or reinforcement is clear and a visual is provided		
Correction or reinforcement is brief and participant returns quickly to activity		
Coach focuses on communicating <i>what to do</i> (not what NOT to do)		
Comments/suggestions:		
Communication		
Coach speaks in a calm tone of voice (i.e. does not yell at the participants)		
Coach uses language that the children can easily understand		
Coach refrains from the use of foul language		





Words and body language used in the correction or reinforcement are positive *		
Criteria	Yes	No
When praise is given, it is specific, not general (e.g. “you are doing _____ well”, not “nice one!”)		
Coach acts and speaks with enthusiasm *		
Comments/suggestions:		

*This looks like: Smiles; nods in the affirmative.

*This sounds like: Cheers; “Sally, you did _____ very well. Way to go!”; “Johnny, I see that you are improving at _____. Great job!”

*This feels like: “High fives;” safe pats on the back; a hand shake of congratulations (use these only if the child/youth is clearly comfortable with physical contact from you).

Counting Interventions During the Activity	Number
Duration of the activity in minutes (when participants are practicing, excluding explanation & demo)	
Total number of interventions with the entire group	
Total number of interventions with individual participants	
Total number of different participants with whom the coach intervened	

Remember, more is not necessarily better. The total numbers are only to give you an indication of how often you are intervening and whether you are moving among the group or focussing only on certain participants.





6.3 Giving Feedback

General Comments about Feedback

- Timing is everything: the individual needs to be open to hearing feedback, and near enough to hear what you have to say.
- Draw the skier's attention to some element external to his/her body, or to the anticipated effect of the movement (i.e. what happens to the pole or ski), rather than on the way the movement is being done.
- Allow skiers to practise a skill without too much interruption. The more you talk, the less they can practise!
- Repeating the same general comments such as "That's great!" or "Keep going!" is not enough. It is not wrong to make these comments; however, the most effective feedback goes beyond general encouragement.
- To promote the acquisition and development of skills, the information provided must be specific.
- To be useful, feedback must be accurate. To be accurate, the coach must: (1) have a good understanding of the skills the individual is working on; (2) have a clear reference point as far as correct execution is concerned; and (3) be in the right place/position to best observe the skier's performance.
- In the case of motor skills, a demonstration (i.e. non-verbal feedback or the execution of a very precise movement) is often useful.
- Although feedback is important and contributes to learning, avoid giving feedback too often, or too much at any one time.
- Keep in mind that it is the quality of feedback that determines its effectiveness, not the quantity.
- When providing feedback to athletes, coaches should aim for:
 - ✓ Positive feedback.
 - ✓ Specific feedback.
 - ✓ A good balance between descriptive and prescriptive feedback - descriptive feedback that is both specific and positive may influence the athlete's self-esteem in a positive way.





Types of Feedback

First determine whether the skier is making progress or not, and then decide what kind of intervention is best. This is what the different types of feedback would sound like:

Types	Definitions	Examples
Evaluative	The coach assesses the quality of the performance; he/she then makes some kind of assessment or judgment	<ul style="list-style-type: none"> • That's fine! • Good job! • No, not like that! • Not good enough!
Prescriptive	The coach tells the athlete how to execute the skill next time they practise it	<ul style="list-style-type: none"> • Throw it higher! (general) • Get your arm higher! (specific)
Descriptive	The coach describes to the athlete what he/she has just done	<ul style="list-style-type: none"> • The build-up was too slow (general) • Your legs were extended just as they should be (specific)

How Did You Do?

Ask yourself the following questions after a practice. Was my feedback:

- Specific, not general? For example, "You did _____ perfectly!" rather than "That's fine!"?
- Positive and constructive, rather than negative and possibly humiliating?
- Directly linked to the skill or behaviour that needed to be improved?
- Informative and relevant to the most important performance factors?
- Balanced, i.e. it contained information on what the skier has done well, as well as what still has to be improved. For example: "Your _____ (movement) has improved. The next thing to do is _____ (add another level of complexity or refinement to the movement)"?
- Clear, precise and easy to understand?





REFERENCES

Donahue, J. *The Perfect Demonstration*.

The Lesson Plan. *CCBC Leader Manual*, 2000, pp. 230.

Coaching Association of Canada, *NCCP Level 1 Theory manual*, Ottawa, 1989.

NCCP - Module A and B Competition – Introduction, Multisport Workshops.





SECTION 7 - EQUIPMENT SELECTION AND SKI PREPARATION



Coaching Tip: Encourage the education of the skier. Do not do everything for them, but progressively develop their ability to look after themselves.



This section on Equipment Selection and Ski Preparation complements the information provided in section 3 of the Introduction to Community Coaching material, and is directed primarily at supporting you in your role as a coach working with children in the FUNdamentals stage of development.

This section will also provide you with materials that will assist you if you choose to work with athletes in the Learning to Train (L2T) stage and beyond.

7.1 Ski Equipment

Following below are some general guidelines to assist you in determining the kinds of equipment that you need for a good ski experience, as well as what is appropriate for the children you are coaching.

7.1.1 Know the Terms

- Camber.** Camber is the longitudinal arc that is built into the ski.
 - ✓ The arc can be of varying degrees of stiffness.
 - ✓ A single camber ski will have a uniform stiffness throughout the camber.
 - ✓ A double camber ski will have a softer first camber and a stiffer second camber. A double camber is common only to high performance classic skis.
 - ✓ The camber is determined by the mould that is used to manufacture the ski.
 - ✓ A hard track ski and a soft track ski will have different cambers, even if the stiffness is equal.
- Flex or Stiffness.** This is a characteristic of the ski that indicates the amount of force that is required to press it down to a flat surface (the force required for the skier to set the wax in the snow when classic skiing). It is determined by the type of laminates and number of layers of laminates used in building the ski, and is often tested by the manufacturer who will then assign the ski a number in kilograms.
- Base.** This refers to the material used in the manufacture of the base of the ski. There are variations in bases; some are harder, softer, more porous and less porous. It is preferable to have a P-Tex base, rather than a less expensive substitute that doesn't hold wax as well.
- Wax Pocket.** This term describes the section of the base of a classic ski where grip wax is applied, enabling the ski to grip the snow when they place their weight on it.
- Structuring.** This describes the process used to alter the surface texture/finish to allow the ski to glide better on the snow surface. When this process is applied, patterns are pressed or cut into the base of the ski. The purpose of these patterns is to help break up the suction that occurs between the ski base and the snow.





- ❑ **Grinding.** Grinding is a process that uses a machine to renew the base of a ski by removing a thin layer of base material. It has two purposes: to make the base flat; and to press or cut a particular structure into it.
- ❑ **Metal Scraping.** Metal scraping describes the removal of base material with a hand-held sharp metal scraper. This is usually done on skis that have been damaged as skis are now flat and structured when they come from the factory.
- ❑ **Balance Point.** This is the point on the longitudinal axis of the ski where a ski will balance (from tip to tail) on a fairly thin object, like a scraper blade. This point helps determine where to place the binding.

7.1.2 Selecting the Right Equipment

Skis

In selecting skis, the most important step is to determine the purpose for which the skis will be used. An athlete in the Training to Win (T2W) stage of development will have a selection of up to five different kinds of skis (the types of skis are listed below). However, most skiers will not need this many pairs, and, unless they are a serious competitor, they should choose the type of skis that will be the most useful to them in the conditions in which they ski most often. Usually a committed skier (Training to Train stage (T2T) and older) will have one pair of skating skis and two pairs of classic skis. The classic skis should include a stiff-cambered ski for klister conditions and a soft-cambered ski for powder conditions.

Keep in mind that no ski is optimal in all conditions:

- ❑ **Medium Classic Ski (Hard Wax/Soft Klister).** For a hard-packed track, fresh to old snow/abrasive snow; and for a softer track and klister conditions. This ski has a short, slightly stiff camber and can be used for binder/hard wax as well as klister conditions.
- ❑ **Classic Ski (Soft Powder).** For new snow at approximately zero degrees, or for glazy fresh snow in a loose track. This ski should have a long, gradual wax pocket at the front. The ski is too stiff if it requires more than five or six layers of wax.
- ❑ **Classic Ski (Klister).** For a very hard track, dirty snow and klister conditions. This ski has a short, stiff wax pocket.
- ❑ **Skating Ski (Hard Track).** For a hard-packed trail. This ski is very stiff in the middle section, with tips and tails that are not as stiff.
- ❑ **Skating Ski (Soft Track).** For loose powder snow or slush. This ski is not as stiff in the middle section, with a softer tip and tail for floating over loose, deformed snow.

The first step is to establish which type of ski is best for you. Due to the fact that a person cannot “try out” skis in a ski shop, it is a good idea to borrow and experiment with your friend’s skis until you learn what the right flex and stiffness is for you. Note that most of your testing should be done on the flats and uphill. Try and duplicate the skis that work best for you by comparing them with the skis in the store. Begin by comparing the calibration (categorization) done by the manufacturer. Skis with the same specifications are usually similar to each other.





In addition, you should use the following camber tests to help with the comparison:

- ❑ **Skating Ski.** Place a pair of skis on a smooth flat surface. Stand on the skis with your weight equally distributed and your toes on the balance point. A skating ski should have no more than the middle third of the ski off the surface, extending 50% on each side of the balance point. If the ski has a soft camber, it will barely support your weight; if it is a hard track ski, it will be very stiff (the hard track ski should still be reasonably soft in the tip and tail sections). Now stand on one ski only. It should be possible to move a piece of paper freely under your foot. Repeat with the other ski.
- ❑ **Classic Ski.** Place the skis in the same position you did the skating skis - stand on both skis with your toes on the balance point. The purpose of this step is to measure the length of the wax pocket. To do this, your weight should be evenly distributed. Then slide a piece of regular paper through the length of the pocket. Ideally the pocket will be approximately 50 cm in length. Next, place all of your weight on one ski. This should pinch the paper between the ski base and the flat surface. Repeat with the other ski.

The most common error is to pick a ski that is too stiff. It is best to err on the side of skis that are slightly too soft than skis that are slightly too stiff. With a softer ski, you can reduce the length or the thickness of the wax application, and still maintain good performance. However, if a ski is too stiff, it is difficult to obtain good grip. This is even more pronounced in the case of beginning skiers who have not yet developed a good weight transfer to help them to flatten the ski on the snow effectively when they “kick”.

In addition to the “paper test”, you may wish to use a hydraulic clamp, or simply squeeze the skis to learn more about their camber. Then compare the camber from the skis in the store with the borrowed skis that worked for you.

When selecting classic skis, it has been traditional to use the ski length as a guide, and for the tip of the skis to reach to the bottom of the wrist when the arm is extended above the head. This can be used as a general guide to finding the right ski, but it is more important to select one with the right camber for your weight and technical ability. For adults, the length of a skating ski should be approximately 15 cm shorter than the traditional classic ski length.

Once the correct camber is determined, the skis should be inspected visually for any defects in the base. The visual inspection should include checking the thickness of the base, the grooves (straight, defects, etc.), and whether there are any lumps/bumps or other base irregularities. Also check for twists in the ski, and that the camber closes uniformly.

Boots

- ❑ Boots should be comfortable. A constrictive ski boot doesn't allow proper circulation. On the other hand, boots that are too large can lead to blisters and less control on hills.
- ❑ You will require classic boots for classic skiing and skating boots for skating.
- ❑ Good quality boots are worth the investment.
- ❑ There are two boot/binding systems - Salomon (SNS) and NNN. Both are good, and equally functional.





Poles

- ❑ As a starting point, classic poles should reach under the arm of the skier when they are standing on the floor. Poles used for skating should be the same height as the chin. These are good reference points and skiers can adjust from there. There is no advantage to using longer poles.
- ❑ Poles are generally made of fiberglass, carbon fibre or aluminum. The lighter the pole, the higher the price. Only elite racers can benefit from the lightest poles and often these are more prone to breaking than the less expensive models.
- ❑ Baskets generally have a “half moon” design. Rounded baskets are only used for skiing in deep snow that hasn’t been packed, such as off-track skiing.

7.1.3 Ski Equipment Considerations for Children in the FUNdamentals Stage of Development

Parents are unlikely to have the information they need to ensure their child has the appropriate ski equipment for a good ski experience. In addition, parents probably don’t know how to prepare their children’s skis for a practice. It is therefore very important that parent meetings are held annually before the ski season begins, in order to prepare them for their role in supporting their children.

It is preferable for children at Levels 1 and 2 in the skill development progression to have waxable skis, even if it is their first pair. The skis can be dual purpose (classic skis that can also be used for skating), but poles must remain “classic” length if only one pair is purchased.

Skating technique is usually introduced at Level 3. A child can learn skating technique skills while using classic, dual-purpose skis, but now they will require both skating length poles and classic length poles. For skating technique sessions, skiers using the classic, dual-purpose skis must have the grip wax removed from the kick zone and the entire length of the ski prepared with glide wax. For classic technique sessions, the kick zone must be in place again, and grip wax must be applied. It is also important that the skiers are using bindings that do not rub the track when the ski is on edge or when the skating technique is used.

By Level 4 the parent should be advised to provide their child with two sets of equipment (both skating and classic) if his/her ski skills and future involvement in the sport appear to warrant the investment.

Skis

- ❑ Classic skis should reach just below the wrist of the child’s outstretched arm, and the camber should be suitable for classic skiing. A basic camber test (“paper test”) should be performed to check that the camber is suitable. When the child is standing on one ski, the ski base





should fully contact the flat floor under the foot; when the child is standing on both skis at the same time, a piece of paper should be able to slide between the ski and a flat floor for about 15-20 cm. This movement indicates that the ski's camber is appropriate.

- Skating skis should be 3-4 cm above the head of the child, and the camber should be suitable for that technique. When the child is standing on one ski on a flat floor, it should be possible to pull a piece of paper out from under the foot with a gentle tug.
- Dual-purpose skis should be of a length mid-way between the length of a classic ski and a skating ski, but the camber must be determined by what is suitable for classic skiing.
- If the skis are not of the correct length and camber, the child will have difficulty mastering the technical skills necessary to become competent in the sport.

Poles

- Poles must have adjustable straps.
- If poles are too long or too short, the child will have difficulty mastering the technical skills necessary to become competent in the sport.

Boots/Bindings

- Select bindings that will not rub in the track when the ski is on edge or when skating technique is used.
- Boots must be comfortable. If boots are too large, they will be awkward to ski in and if they are too tight, feet will not stay warm.
- In addition to the annual club ski swap, a boot exchange program within your club can help reduce the cost of purchasing boots during the rapid growth years.

7.1.4 Binding Placement

The Wax Pocket

- The wax pocket for a medium classic ski should extend 10 to 15 cm behind the balance point, and 30 to 40 cm in front of it. For shorter skis, the length of the pocket would be shorter, but the ratio would be the same.
- A classic ski (klister) should have the same wax pocket, but that pocket would be stiffer.
- The wax pocket for a classic ski (soft powder) would be approximately 50 cm in length, of which approximately 35-40 cm would be in front of the balance point.
- Skiers should mark the wax pocket on the side of their classic skis (front and back extent of the pocket) so that they will know where the glide area ends and the wax pocket begins.





Figure 7.1: Camber Pockets

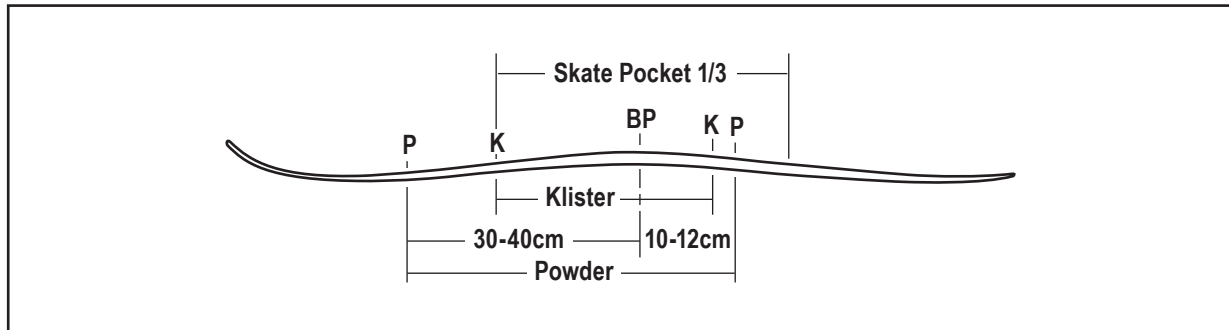

The Binding

- ❑ Often manufacturers will provide a template for mounting a binding. To mount the binding properly you first need to determine the balance point.
- ❑ Skating skis should be balanced to help the skier keep the tip of the ski up so that it is easier to lift it from the snow. It is usual to mount the boot hinge on the balance point, but before you mount the binding, find the balance point of the ski to make sure the front of the ski tips up (approximately 1 centimetre in front of balance point).
- ❑ With classic skis, it is optimal that the ski tip drops. It is usual to mount the boot hinge on the balance point, but before you mount the binding, balance the ski on the balance point to make sure the tip drops.
- ❑ When attaching the binding be sure to put some waterproof glue in the holes to seal the ski.





7.2 How to Care for Your Ski Equipment

7.2.1 Ski Care

Intermediate and advanced skiers whose equipment receives a lot of use should be in the habit of cleaning and re-waxing their skis for glide each day they ski. With classic skis the grip zone should be cleaned and re-waxed for each ski outing. This may appear to be costly in time and dollars, but if a skier becomes skilled in this area this step will be quick, and they will get good mileage from their wax and have better skis.

The quality of the running surface in the ski base deteriorates with use, whether it be the heat from waxing applications, small particles of grit that become embedded in the surface, or scratches in the base. From time to time the ski should be re-scraped or re-ground. Be aware of the base thickness you have to work with when reconditioning a ski. All you want to remove is a very thin layer. If you are uncomfortable with scraping or grinding, a vigorous brushing and fibertex is recommended.

When this is completed, you will need to re-saturate the gliding surface with wax. This is best accomplished using a soft wax first. “Hot scrape” the ski a couple of times. Next, use a harder graphite. Wax, scrape and brush a couple of times. This will give a long lasting base layer.

When traveling, skis should be hot waxed, but not scraped. A soft cloth or commercial ski protector should be placed where the ski bases touch near the tip and tail, and the skis should be securely fastened together. This will prevent grit getting caught between the skis and scratching the surfaces.

It is also important to prepare skis for summer storage. The skis should be cleaned and then hot waxed, but not scraped. The top and side surface of the skis should be cleaned with wax remover. Any nicks or gouges in the top of the ski should be sealed with glue. Tears in the base should be smoothed with fine sandpaper.

Skis should then be stored flat in a location where the temperature and humidity will remain moderate over the summer months.

7.2.2 Ski Care Considerations for Children

Children should be encouraged to develop an interest in how their skis are prepared and cared for, and to associate good ski-care habits with enjoyable ski experiences. This education should begin early – at six years of age.

At least one “ski preparation” workshop, geared to the age and experience level of the group, should be held annually, and proper ski care and preparation should be an ongoing part of every practice session.

To learn more about an appropriate progression of steps for teaching children these skills during the FUNdamentals stage of development, refer to section 5 - Level 1 (Practice Plan 3), Level 2 (Practice Plan 3), Level 3 (Practice plan 12) and Level 4 (Practice Plan 13).





7.3 Base Preparation, Glide and Grip Waxing

Ideal Tool Box for Coaching Children in the FUNdamentals Stage of Development

- ✓ a solid bench; portability is desirable
- ✓ a ski form that will hold the ski securely
- ✓ clamps
- ✓ extension cord
- ✓ good iron (controllable heat)
- ✓ heat gun and/or torch
- ✓ scrapers - metal, plastic, and groove scrapers
- ✓ brushes
- ✓ container for hot water
- ✓ corks
- ✓ wax remover
- ✓ fibertex
- ✓ fiberlene
- ✓ paper towels
- ✓ fiber paper (waxing paper)
- ✓ file and sandpaper
- ✓ miscellaneous: tape, basket, screws, flex plate for binding etc.

7.3.1 Base Preparation

New skis usually come with bases prepared for waxing. If this is the case, follow the instructions under “Application of Glide Wax”.

If your skis did not come fully prepared, or if you are preparing used skis for waxing, follow these fundamental steps:

- First, inspect the ski. Hold it up to the light and look down the base. Look for bumps, gouges, etc.
- Place the ski securely in the form.
- If there are bumps, tears, etc., choose one of the following:
 - ✓ take the ski to a place that does ski grinding and have the base ground;
 - ✓ make passes from tip to tail, in a continuous motion, with a metal scraper. This exercise





requires a steady hand and some experience. If you haven't done it before, you should begin by practicing on a pair of old skis before you try it on your good skis; or

- ✓ use a sanding block with 100 grit sandpaper and sand the ski base from tip to tail until it is flat. Make sure the sanding block is long enough to bridge any discrepancies in the base. Repeat this process using graduated versions of sandpaper (up to 300 or 320 grit) until the ski smooth.
- ❑ Take some fibertex and make a few passes from tip to tail.
- ❑ Generally, the ski will now be ready to wax.

7.3.2 Factors That Affect the Performance of Waxes

Keeping up with all the new wax products can be time consuming and expensive for a club coach, and this is not necessary. By using a fairly complete selection of one - and at most two - of the major wax brands, you can get good performance in almost all snow conditions. The wax box for a coach can be reasonably simple. For grip waxes, include a base binder, a green range, an extra blue range, a violet range, and a special red range. For klisters, include purple (or a binder for icy conditions), special red (for damp conditions), red (for slush) and universal. For glide, include a few non-fluoro paraffin glide waxes. A coach should be able to cover most situations with this collection of waxes.

Factors that affect the performance of all waxes are:

- ❑ **Trail Conditions.** The starting point for determining which wax to use is the ski trail itself. How well packed is it? How long has it been since it was groomed? How many skiers have skied on the tracks?
- ❑ **Air and Snow Temperature**
 - ✓ Manufacturers normally identify snow type and the air temperature range on their wax products. The next step for determining which wax to use is to take a reading of the air temperature in the shade.
 - ✓ If you are waxing for an important competition, you would take a reading at several points along the course, including the highest and lowest points.
 - ✓ If you plan to use snow temperature, keep in mind that it will remain the same once it reaches the freezing point (zero degrees Celsius), regardless of rising air temperature. When this happens it is necessary to switch to using air temperature.
- ❑ **Humidity.** Humidity is a critical factor influencing waxing decisions. Usually this information is included in the local weather forecast. If you are waxing for a competition, your club may have its own equipment for taking humidity readings, to complement what is provided by the weather forecast.
- ❑ **Type of Snow.** As snow ages, the points of the snowflake become rounded. The more rounded the snowflakes, the softer the wax that is needed. Snow also ages as a result of skier traffic. The more the trail is used, the softer the wax that is needed.
- ❑ **Application.** Care must be taken when applying wax. It must be applied in smooth, even





layers. If the wax is lumpy, performance will decrease and grip waxes will be prone to icing.

For future reference, you may wish to routinely record snow conditions, air temperature, how you applied the wax and how the wax worked.

7.3.3 Application of Glide Wax

The first step in preparing skis is to get the work area set up. Make sure your scrapers are sharp, your brushes are clean, there is good lighting, etc.

Waxing and Safety

- When ironed-in heating of either fluorocarbon or non-fluorocarbon glide waxes is required, the process must be conducted in a well-ventilated area.
- Excessive heating of the products must be avoided. The application temperature should be less than 115 degrees Celsius.
- Reliable respiratory protection in the form of a canister mask for organic vapours and dusts must be used by persons within the application area.

Place the ski in the ski form.

- Make certain the ski is fastened down.
- Preheat the iron and let it stabilize. Make sure you have enough cord length.
- The iron should be hot enough to melt the wax, but not hot enough that it begins to smoke.
- Clean the ski by using wax remover or hot wax and a sharp, plastic scraper.
- To clean a ski with hot wax, first melt a layer of soft glide wax onto the ski, and then scrape it off with a plastic scraper while it is still molten. For scraping the flat surface of the ski, use the regular, sharp edges of the scraper, but for scraping the sides of the ski, use the ends of the scraper or you will damage it.
- If the ski is dirty, you need to brush on wax remover, and then remove it with a plastic scraper before it evaporates.
- When the ski is clean, you can begin glide waxing.
- Lay a thin bead of glide wax on both sides of the groove. If you are preparing a classic ski, do this in the glide zone only, not in the grip zone.
- When melting wax, ensure there is good ventilation in the waxing room. Do not allow the wax to become so hot it “smokes”.
- Melt the beads of wax with one or two passes of the iron from tip to tail. Use long, continuous strokes (no pausing) from tip to tail. The long strokes prevent the ski from becoming too hot.





Do not allow the iron to stop in one place, or use a “scrubbing” motion.

- Scrape the groove and the sidewalls of the ski before it cools. Become familiar with using a round groove scraper for scraping the grooves.
- Let the ski cool to room temperature. This will take 20-30 minutes.
- Scrape the ski with a plastic scraper until all visible wax is removed.
- Brush with a nylon brush in order to remove any excessive glider from the base.
- If you are using a fluoro wax, the use of Fiber Paper (waxing paper) between the ski and the iron is recommended. Waxing paper allows you to use less wax (i.e. saves money), assures good distribution of the wax, and provides a buffer between the iron base and the ski base (it provides a better buffer than fiberlene because it is thicker):
 - ✓ Crayon a thick layer of wax onto the ski base.
 - ✓ The iron needs to be hot enough to melt the wax when the waxing paper is between the iron and the ski.
 - ✓ Begin at one end of the glide zone, and go slowly to the other end. Usually you will hold the waxing paper with one hand, and pull it along with the iron. However, when the iron is set to the correct temperature, you should be able to move the iron along by pulling the waxing paper. In this case the iron is floating on the molten wax layer.
 - ✓ Remember that you should not “scrub” with the iron.
 - ✓ After the first pass, check to see if the base has a complete cover. If not, touch it up now. Altogether, you should make two or three passes with the iron/waxing paper.
 - ✓ Always check that the base is not overheating. If you can't hold your hand on the base, it is too hot.
 - ✓ Remember that you will get better wax absorption using as high a temperature as possible (without actually “smoking” the wax). On the other hand you can sear a base with excessive heat if you are not careful.
 - ✓ As long as the waxing paper is clean you can continue to use it for the same wax type.
 - ✓ Usually the iron has to be set 20 degrees warmer for the same wax type if you are using waxing paper.
 - ✓ You do not need to use the waxing paper for the paraffin glide wax or for powders.
- Non-fluoro (paraffin) waxes cover a range of temperatures. If you are using a warmer non-fluoro wax, follow the application directions at the beginning of this sub-section, and make sure the wax layer is thick enough to completely cover the ski when it is being ironed in. Scrape when the wax has cooled.
- If you are using colder non-fluoro wax, use the same application process as you did above, but the removal of the wax will be different because of the chipping that occurs when the wax hardens. In this case, do the initial scraping while the wax is still warm. This will help to prevent chipping. When the ski has cooled, scrape and brush as normal.





7.3.4 Application of Grip Wax

- ❑ If skis have been glide waxed previously, the glide zones need to be scraped and brushed.
- ❑ Always scrape and brush from the border of the grip zone to the tips and tails of the ski. The reason for scraping and brushing in this manner is to keep the grip zone free of any material that could interfere with the adhesion of the grip wax.
- ❑ When the glide zones are finished, clean the grip zone with wax remover. Be careful not to get any wax remover on the glide zone.
- ❑ When the grip zone is dry, abrade it with sandpaper, using longitudinal strokes moving from the ends of the grip zone, and working towards the middle. Use 80 grit sandpaper for abrasive snow. Use 120 grit sandpaper for non-abrasive snow.
- ❑ Using a sharp plastic scraper, remove any hairs that might be attached to the base.
- ❑ If needed, a base binder can be applied now:
 - ✓ If you are planning to use a binder, it should be left outside freezing while you are getting ready to use it. Freezing the wax allows it to be rubbed on in thin layers, and avoids the big lumps that are difficult to spread with a cork.
 - ✓ Next, warm the ski with a heat gun or iron and spread the binder. It is best to use a cork and work the binder into the base for better adhesion.
- ❑ If you are planning to use hard klister as a binder, keep the ski at room temperature and warm the klister:
 - ✓ To warm up the klister and still keep it at a workable consistency, place the tube in a can of warm water (or use a heat gun). Another is to place it in the sun when the sun is sufficiently strong. Be careful that the klister doesn't become too warm or it will run everywhere.
 - ✓ Next, apply a thin layer of klister using the same procedure mentioned above for a base binder, and spread it over the grip zone.
- ❑ Before applying the grip wax over the binder, allow the binder to cool down outside:
 - ✓ Rub 3-4 thin layers onto the grip zone of the ski, smoothing out each layer with a cork as you put it on.
 - ✓ It is best to start at the outer ends of the zone and work towards the centre.
 - ✓ If the camber is correct, *and if the camber is marked correctly*, that will be enough.
 - ✓ If you do not have adequate grip, add one or two more layers.
 - ✓ If you have to build up a number of layers, it can be helpful to take the ski outside after the first few layers to cool it down. Then finish the job.
 - ✓ If you still do not have adequate grip, the next step is to apply a warmer wax in the centre of the wax pocket.
 - ✓ If the warmer wax proves to be too sticky, cover it with a thin layer of the grip wax that was used originally.





- ✓ Finally, if the grip is still inadequate, you should scrape it all off with a plastic scraper and repeat the process with a softer wax (klister).

Application of Klister

- The first step is to clean the grip wax pocket of the ski with wax remover.
- Next, warm the klister tube (use warm water in a can, your hand or a heat gun).
- Poke a small hole in the top of the tube.
- Squeeze short, thin strips on both sides of the groove, in a uniform manner, in the grip zone of the ski.
- The strips should be horizontal, from the groove out, rather than running the length of the ski. The wax will smooth out better if it is applied this way.
- Duplicate the amount of klister on the second ski.
- Spread it evenly using your thumb, a klister brush or the klister spreader that comes in the box.
- If the layer looks too thin, you can always add some more. However, keep in mind that klister is easier to add than remove.
- When the klister application is finished, allow the ski to cool for at least 10-15 minutes before using it. Perhaps the greatest cause of problems with klister is inadequate cooling and the subsequent icing.

7.3.5 Waxing Skis for Children

It is necessary for parents to prepare the skis for younger children.

Children six years of age and older can begin to prepare their own skis, but only under the close supervision of an adult.

By eight years of age, children should be learning to apply their own kick wax. If they have acquired basic waxing and ski preparation knowledge by ten years of age, they can also be introduced to klister.

However parents need to take responsibility for the glide waxing of the skis. If a parent is unable to prepare the skis themselves, a ski friend with waxing experience or a local ski shop should be able to provide assistance. For skiers at this level, glide waxing should be done at least twice a ski season. It should be done before the first ski session and then again during the middle of the ski season. If the skis receive a lot of use, they may require glide waxing more often.

Note that a wax kit that meets the needs of a young skier can be simple and still cover all snow situations.





Recommended Wax Kit

Cork and plastic scraper.

Paper towel.

Grip wax: one package of a recognized brand that covers the full temperature range (approximately six grip waxes).

Klister: universal klister.

Glide wax: one warm range and one cold range non-fluoro paraffin glide waxes.

The “kit” can be a small plastic box with a lid, a little cloth bag, a fanny pack, etc. This kit helps to reduce the chance of items being lost in the wax area during the ski session or workshop.





REFERENCES

Masson, A., *Waxworx*. Ski Trax.

NCCP Cross Country Skiing Level 2 Technical manual.

Wood, D., *Stay Tuned, Glide Waxing for Advanced Skiers*. Ski Cross Country.

Wood, D., *Stay Tuned, Ski Selection & Preparation*. Ski Cross Country.





SECTION 8 - INTRODUCING COMPETITION TO CHILDREN



Coaching Tip: In the hands of the right people, with the right attitudes, competition can be a positive, character-building experience. It provides one of the best opportunities for children to come in contact with rules and social conventions. It defines the need to get along well with others, and to be accepted as part of a team. It plays a prime role in promoting values such as tolerance, fairness and responsibility.

Source: Straight Talk About Children and Sport



8.1 Children and Competition

Competition is a fact of life! There is a wide gap, however, between a healthy, nurturing competitive environment that is ideal for young children, and the aggression-based environment that is seen all too frequently in children's sport activities. Because there is a "right" approach and a "wrong" approach, every parent and coach must, at some time, reflect on the best way to introduce children to competition. Children's first experiences with competition will have a significant influence on their attitudes towards such activities, as well as on the sport or sports towards which they are attracted. Before signing up a child for a cross-country ski competition, take a close look at the following guidelines. They are designed to help a child get started the "right" way.

The time to teach youngsters important values such as the spirit of competition and how to cope with defeat is in the formative years. They need to be taught at an early age how to celebrate accomplishments even if they don't win the competition.

Ken Shields: former coach, Canadian Men's Basketball Team

8.1.1 The Benefits of Competition

In the hands of the right people, with the right attitudes, competition can be a positive, character-building experience. Competition provides one of the best opportunities for children to be exposed to rules and social values. It defines the need to get along well with others and be accepted as part of a team. It plays an important role in promoting values such as tolerance, fairness and responsibility.

Competitive sport helps participants to:

- Learn to work as part of a team.
- Learn to manage success and disappointment.
- Learn patience and perseverance.
- Learn responsibility and time management.
- Learn to manage stress.
- Learn to interact and relate with a variety of other people in a variety of situations; e.g., team mates on trips, officials at competitions, coaches and other competitors
- Learn to set and achieve goals.
- Learn respect for others.
- Gain physical fitness, develop body awareness.





- Gain confidence in their abilities and improve their self-esteem.

Children tend to be attracted naturally to competitive sport. From an early age they try to jump higher, throw farther or climb higher than their brothers or sisters. Competition is not a problem for young children. Problems only arise when someone else - usually a poorly informed coach or an overly enthusiastic parent - distorts competition by over-emphasizing the value of winning.

Children don't join a team to sit around and do nothing. Sport is not enjoyable if they don't get much opportunity to play. Studies have shown that children would rather play for a losing team than be a member of a winning team and sit on the sidelines. If they're not playing, they'll lose interest quickly.

Straight Talk About Children and Sport.

8.1.2 Getting Started the Right Way!

FUNDamentals Stage of Development

The main emphasis should be fun and skill/speed development. Use unconventional race settings to optimize this development (e.g. obstacle courses, terrain parks, games). In this stage:

- Basic technical skills are a prerequisite.
- Encourage children to attend competitions as part of a club team.
- Ensure suitable ski equipment (boots, waxable skis, poles).
- Ensure the child is dressed appropriately for the weather, as well as the competition.
- Use varied terrain; include some unconventional settings (i.e. obstacle courses; terrain parks; skills races).
- Select events that recognize team effort and participation - not just winning.
- Select relays/races of different kinds, so that the winners are not always those that ski fastest.
- Downplay results; reward enthusiasm, improved skills, effort and respect for others.
- Four to six races a season; begin after four weeks on snow (after Christmas).
- Keep extended travel to a minimum; use local or neighboring club races of varied types (club fun races, relays, sprints, inter-school "fun" events and even regional or Provincial/Territorial Cup races *if* they are close to home, and *if* the skier has appropriate skills).
- Recommended distance races: 0.5 to 1.0 km (5 to 10 minutes); begin with shorter distances and increase over the ski season.





- Recommended sprint distances: 100 to 200 metres (skills race). Longer sprint races that fall outside the recommended race times may still be appropriate as long as those events are designed to emphasize skill development, thus reducing concerns about the use of inappropriate energy systems for the FUNdamentals stage of development. Typically, these events would be held on a ski playground sprint course that integrates several skill-challenging components that would disrupt the high racing tempo that is normally associated with sprint races. These are called “skills races”.
- Adapt race distances to race “time” guidelines for the stage of development.
- Select short races that encourage speed and good technique (not endurance).
- No racing if the temperature is -15 degrees Celsius or colder (plan alternative activities in case of cancellation).
- The club program for this age group should not focus on competitions. Competitions should be presented as just one more activity in a well-rounded ski program.
- All participants eight years of age and younger should receive a recognition award (such as a ribbon).

If young skiers require any assistance from their parents during a competition (from the time they enter the start enclosure until they leave the field of play after finishing the race), they are not ready to compete!

8.1.3 What Does Success Mean to a Child?

Children don't think like adults. They view success differently and these views differ with age, gender and the type of sport they play. British researcher Dr. Jean Whitehead asked 3,000 youngsters aged nine to 16 years to describe what success in sport means to them. She received these answers from primary school children.

- “I did my first back dive in front of my brother and my dad.”
- “I swam a length with nobody helping me.”
- “We were practising and I was the only one who could do it.”
- “I practised and practised, then one day I did it!”

These replies show that children don't see winning as the only kind of success. In fact, winning is most often cited last when children are asked about their reasons for participating.

In an article in *Coaching Children in Sport* entitled “Why Children Choose to Do Sport - or Stop”, author Whitehead writes: “Young children are more concerned with mastering their own environment and developing skills than beating others - at least until someone tells them that it is important to win.”





Up to about age ten, children believe that success is based upon effort and social approval. Because their capacity to assess their own ability develops more slowly, they cannot have clear expectations about how successful they will be in sport. They believe that those who try hard are successful, and if you are successful, you must have tried hard. Children in this age bracket tend to think of success as finishing the race, regardless of whether they placed first, second or 20th.

At about six to seven years of age, children start to compare their skills with those of other children. They start to wonder whether others can do the same things they can. Things that are those things that few others can do. It is not until about 12 years of age that children are able to tell the difference between skill, luck, effort and true athletic ability.

Because children are not good at judging their own ability, they depend on others to tell them how well they are doing in developing skills and how they compare to their peers. This places enormous responsibility on parents and coaches not to set standards that are too high.

The tendency to value winning above all else has been recognized as the cause of many problems in children's sport. When winning is kept in perspective, the focus becomes more appropriately placed on striving to win and the pursuit of victory. Successful coaches recognize that teaching children how to master new skills and strive for excellence will produce children who can compete against others and feel good about themselves.

Straight Talk About Children and Sport





8.2 Parents Code of Conduct

- Keep in mind that children are involved in organized skiing for their enjoyment, not yours.
- Remember it is the children who are competing in an event, not you! The youngsters at the start line aren't you! If they make a mistake, it is *their* error; if they win an award, it is *their* achievement. Glory or grief, it is *their* competition.
- Encourage skill improvement, sportsmanship and an honest effort by recognizing achievements in these areas.
- Cheer *all* the competitors. Recognize and applaud a good effort when it is deserved. Be supportive and positive to *all* the children competing in the event. Praise the efforts of *all* the young skiers after a competition, especially if they did not do well. Be sincere!
- Encourage your child when he/she is competing, but be careful what you say. Yelling instructions can make children nervous. Shout only general encouragement or key words that have been previously discussed with the coach and your child.
- Teach your child that the rules of the competition are mutual agreements, which no one should evade or break. Encourage your child to respect the rules and the officials who make decisions on rulings.
- Never “pace” your child during a competition. It is against the rules! A child could be disqualified as a result of this type of infraction. Remain stationary and off the actual competitive course as your child skis past you.
- After the competition, give the child peace, quiet, dry warm clothes and perhaps a drink.
- Be supportive of the coach and help him/her when you can. Coaches give their time and resources to provide skill development and ski activities for your child.
- Be supportive of and thank organizers and officials. They are volunteering their free time to provide your child with an opportunity to participate in a competition. Encourage your child to say thank you to at least one official before they return home.
- Remember to keep competition in perspective. It isn't a World Cup, or an answer to world hunger, or the Olympics. *Let it just be fun!*





8.3 Competition Model for Cross-Country Skiing

Research in Canada shows that one of the largest contributing factors to children dropping out of sport is insufficient “game time”. For our sport, “game” translates into the testing of skills against peers in relays, races, treasure hunts, sprints, etc. with an emphasis on “team effort”. It isn’t enough to simply do practice sessions with drills; children need to be challenged.

Ski Cross Country

A well-balanced skill development program for children in the FUNdamentals stage of development would include approximately one hour of “**game-time**” for every three hours of skill instruction. Imagine soccer practices week after week without the participants playing a “game” at some point during the season! Imagine basketball practices where the participants learn basic skills week after week without ever playing a basketball game – not even a house-league game! Formal skill instruction sessions are not enough to keep a child involved in sport.

Children need to be challenged. They need an appropriate ratio of “game-time” versus formal skill instruction in order to test their skills against their peers and to motivate them to continue to improve those skills. As a result, FUNdamental competitive activities are an important component of a successful skill development program.

As a general principle, children should get their first exposure to competitive activities in the context of games during practice sessions, or in a special event specifically organized for their age group. When they learn the skills to manage one level/type of competitive activity, they are ready to graduate to the next one.

8.3.1 The Different Race Formats

There are five race formats currently used in cross-country ski competitions. Four of these formats have “mass start” components, which emphasize “head to head” competition, and which allow spectators to follow the story of the race as it unfolds:

- Interval Start.** A time-trial format in which competitors usually start 15 or 30 seconds behind one other and compete against the clock.
- Relay.** A traditional relay format with teams of three or four persons. The first skier from each team starts at the same time, and then hands off to the next skier at the end of the first leg. This continues until each member of the team has skied the prescribed course.
- Team Sprint.** A two-person sprint relay. The first skiers on each team race the course, then hand off to their team mates, who then ski the course. The second skiers then hand off to the first skiers who ski the course again. And so on. Each skier will complete three legs before the race is over.





- ❑ **Individual Sprint.** This event begins with a time trial to rank the skiers. Following that is a program similar to a “round-robin tournament”, in which the “heats” usually have four skiers each. The two fastest skiers from each heat move on to the next round.
- ❑ **Mass Start.** All skiers start the race at the same time.
- ❑ **Pursuit.** Two races in one. Skiers will ski one part of the race using classic technique, and the other part using skating technique – changing over mid-way. Several variations are used.

According to a USA Today / NBC telephone poll, almost three out of four children ages ten to 17 years said they wouldn't care if no score was kept during a game.

Straight Talk About Children and Sport

8.3.2 An Appropriate Competitive Pathway

- ❑ **Games during Practice Sessions.** Falling tag, British Bulldog, etc. Refer to “*Practice Plans*” (section 5) and “*Games for Teaching Technique*” (section 4.3.9) for additional suggestions. Appropriate for children six years of age and older.

These activities are organized by the coaches leading the session.

- ❑ **Advanced Games.** Games organized for a specific age group – treasure hunt, relays using correct exchange procedures, etc. Appropriate for children six years of age and older depending on the skill level of the group. Ensure all participants are recognized.

These activities are usually organized by the coaches/parents involved with a particular group of children. If the club is large enough, there may be two or three groups of Level 1 skiers, Level 2 skiers, etc. The coaches/parents for each level can then join forces and share the work of coordinating the activity.

- ❑ **Racing Rocks! Activities** (Ski Tournament/Team Sprint/Double Cross). This type of event provides children with the opportunity to experience the fun and excitement of applying their cross-country ski skills in a variety of contexts - in an environment of adventure and intra-group competition - thereby providing a good introduction to organized competitive skiing. Refer to section 8.3.3 for details.

Racing Rocks! events are usually organized by the broader ski club. In this case the role of the coaches is to teach their group the skills that are required in order to have a positive experience.

- ❑ **Club Races.** Refer to the “*CCC Athlete Development Grid*” (section 2.4) and “*Getting Started the Right Way*” (section 8.1.2) for guidelines to help you select appropriate races for your skiers.
- ❑ **Regional Races.** Refer to the “*CCC Athlete Development Grid*” (section 2.4) and “*Getting Started the Right Way*” (section 8.1.2) for guidelines to help you select appropriate races for your skiers.





- ❑ **Provincial/Territorial Midget Championships.** A special competitive activity suitable for skiers in the Learning to Train stage of development. The objective of this event is to bring young skiers from a province or territory together for a weekend of cross-country ski competition and fun, encourage achievement through team effort and promote good ski technique.

8.3.3 Racing Rocks!

❑ Ski Tournaments

A Ski Tournament is a one-day festival of special activities targeting the needs of children in the FUNdamentals and L2T stages of development. As a minimum, it would be expected to include an individual sprint race (Mad Dash), a terrain park relay and several other activities. These additional activities might include a treasure hunt, three-legged race, monster skis race, Beat the Field, on-snow orienteering contest, opening and closing ceremonies, and so on.

The Mad Dash (individual sprint race) for this age range begins with a draw to determine the start positions of the skiers. Following are the “elimination heats”, which should not have more than four skiers each. The two fastest skiers from each heat move forward to the next round. The remaining skiers in that heat may move to a consolation round at the discretion of the organizers.

A Terrain Park Relay has teams of three or four persons and follows the same basic rules that traditional relays do. The first skiers from each team start at the same time and then hand off to the next skier at the end of the first leg. This continues until each member of the team has completed the prescribed course.

Guidelines for organizing a tournament:

✓ Promotion

- The tournament notice should include all the necessary information that the participants will require. It should be planned carefully, and there should be *no changes* after it is distributed. Set your registration deadline at least one or two days prior to the event so that you can make up teams as necessary and develop start lists. In the notice, include the start time, good directions to the location and the availability of a day lodge and/or washrooms. Don't forget to note any refreshments that will be provided and the accessibility (or not) of food and water, so that participants come prepared. Promote your event in local elementary schools and to other sport groups in your community. The intention is to encourage increased participation by those who are not members of ski clubs as well as those who are! The more kids you can get involved, the more fun they will have!

✓ Formats/Techniques

- **Mad Dash:** Individual sprint; free technique; random draw. All skiers should be offered the opportunity to participate in a minimum of two heats. If participation numbers are small, categories can include skiers of different ages provided the recommended distances for those ages are the same. However, recognition awards should be provided for every year of birth and for both genders.





Mad Dash for children eight and under: the competition should be held on a short obstacle course with obstacles to go around, jump, side step, go backward, etc.

Mad Dash for children nine to 13: the sprint course should be well packed and fast so that the majority of the skiers can complete it in 20 seconds or less. The course should be on a slightly declining slope.

Distances (boys and girls):

8 & under 50-60 metres

9 - 12 100 metres

- **Terrain Park Relay:** classic technique; three or four person teams; mixed genders. A minimum of two age categories must be offered; more categories if participation numbers warrant it. Ideally the competition should be held in a terrain park setting with obstacles, uphill, downhill, jumps, hoops, etc., but a more traditional competition course will work as well with some adaptations.

Distances (boys and girls):

8 & under 4 x 0.5 km

9 - 12 4 x 1.0 km

Classic tracks must be set on the side of the course for free technique events as this is an entry level competition and some of the participants may not have the technique skills or the equipment for skating.

✓ **Hosting Requirements**

- The stadium and trails need to be well packed, and prepared for both classic and skating techniques.
 - Organizers will need manual stopwatches, numbered bibs for every participant in the Mad Dash, relay bibs (made of durable paper) for the terrain park relay, clip boards, pencils and paper, course markers and an adequate number of race volunteers/officials to ensure the safety of the skiers.
 - A participant award should be provided to every child.
 - Prizes should be available for skiers with the best classic technique and the best skating technique – at least one for each male and female for each year of birth. Evaluation takes place throughout the day. A minimum of two NCCP Level 2 or higher coaches working as a team can be used as “judges” for selecting skiers for these awards.
 - Prizes should be awarded for the sprints, relays and other activities as well. These prizes can be as simple as a certificate or a candy. Be generous with the number of awards you give out.
 - Skiers may only enter in one age category for the duration of the event. When skiers initially register, they can enter in an older age category, but not a younger one.
- ✓ **Team Aggregate Award.** The following is an example of a team aggregate award. Each participating team accumulates points towards the Team Aggregate Trophy. Team points are earned as follows:





1	No. of participants in an individual start race	1 point per participant
2	No. of official teams in a relay event	6 points per team
3	No. of participants in a sprint race	1 point per participant
4	Top 4 placings in an individual start race (<i>this is in addition to points earned for participation</i>)	5, 4, 3, 2 points
5	Top 4 placings in a sprint race (<i>this is in addition to points earned for participation</i>)	5, 4, 3, 2 points
6	Top 4 team placings in an individual start race (<i>based on total time of the best four times</i>)	5, 4, 3, 2 points
7	Top 4 team placings in a relay event	10, 8, 6, 4 points
8	Top 5 - best classic technique	5, 4, 3, 2, 1 points
9	Top 5 - best skating technique	5, 4, 3, 2, 1 points
10	Top 4 placings in other activities	5, 4, 3, 2 points

Points are calculated for official teams only. The team with the most overall points wins a Team Aggregate Trophy (be creative – the trophy could be made of popcorn!)

❑ Team Sprints

A Team Sprint is a two-person sprint relay. The first skiers on each team start together and race the course. They then hand off to their team mates, who also ski the course. The second skiers then hand off to the first skiers who ski the course again. The race is over when each skier has completed two legs.

Organizers need to decide in advance whether the race will be skating technique only, classic technique only, or a mix of the two.

If participation numbers are small, categories can include skiers of different ages provided the recommended distances for those ages are the same. However, recognition awards (ribbons, cookies, etc.) should be provided for every year of birth and for both genders.

A random draw, with normal relay start positions (#1 is in the centre track, # 2 to the right of #1, # 3 to the left of #1, etc.) should be used. The competition begins with a mass start. The number of teams that can start at one time will depend on the width and layout of the course. As a result, the largest number of teams that can be accommodated in a single category may not be more than five or six. The start should have parallel tracks (one for each team) that are straight for at least five metres. Starters may not change lanes until they have reached the end of their start lanes. The finish line must be wide enough for three skiers to finish simultaneously. The exchange zone should be situated after the finish line, and scaled





down in length to fit the distance of the race and the age and skill level of the participants. Some manner of ski preparation pits or stalls should be provided close to the exchange zone where the finishing skiers can wait for their next turn, and they and/or their coaches can work on their ski equipment, etc.

The competition courses can be the same ones used by the club for individual (heat) sprints, but the distances must be short because the skier will be skiing the course twice in a short period. A terrain park or ski playground could also be used as long as there is sufficient width.

Distances for each leg of the event (boys and girls):

8 & under	Not more than 50 meters
9 - 10	Not more than 75 meters
11 - 12	Not more than 100 meters

❑ Double Cross

Since the introduction of skating, higher technology equipment and new race formats such as sprinting, pursuits and mass starts, cross-country skiing has picked up speed and grown in excitement. At the leading edge of this trend is “Xtreme X-Country”, which at a basic level involves learning to ski through jumps, bumps and other features in a “terrain park”, or ski playground. Xtreme X-Country emphasizes basic athletic skills such as balance, agility, strength and the ability to adapt basic sport skills to an unusual setting.

Organizers need to decide in advance whether the race will be skating technique only, classic technique only, or if skiers can use either technique. Other decisions might include the use of poles – or not, mixed age categories, boy/girl teams, etc. Numbered race bibs are essential.

The competition course requires an elevated start, and should be designed so that the skiers can build up speed during the early stages of the race. The objective is to have a fast, roller-coaster course that demands fast turns, jumps and shifts in technique. The best venue to do this may be your club ski playground or terrain park. Keep in mind that the course must be suitable for the age and skill level of the participants and safety is always the first consideration.

MUSIC is an important component of this activity.

Following are four possibilities for a Double Cross format:

- ✓ **DC Option #1:** set up three stations and four groups/teams of skiers. Each station should have a different course with different challenges. The teams then rotate from station to station, using the break in between to get hot chocolate, etc. Each participant contributes to points for their team by completing the assigned course at each station. The team as a group earns points by their combined times at each station. The number of points they earn as a group depends on their ranking in comparison to the other teams. This option requires timing and a team aggregate winner.
- ✓ **DC Option #2:** set up as many as four “barrel racing” loops, depending on the number of participants. Each loop has two skiers competing against each other, going in opposite





directions around the course. The top skier from each round moves on to the next round. The bottom skier moves into a consolation round. No timing required.

- ✓ **DC Option #3:** set up one competition course that is wide enough for two to four skiers to compete at the same time. These skiers start at the same time and compete head-to-head. The top skier, or top two skiers from each wave move onto the next round. The bottom skier or bottom two skiers move into a consolation round. For a fast action event, the second wave of starters can begin before the first wave is finished, depending on the judgement of the starter. Note that the start line needs to be adjusted to take into account the advantage of being on the inside if the course turns to one side or the other soon after the start. No timing is required.
- ✓ **DC Option #4:** if the competition course in option #3 is one continuous loop (except for the elevated start for the initial skier), a Team Sprint format could be used in order to encourage team work among the skiers.

Distances (boys and girls):

8 & under	75 metres
9 - 12	100 metres

Race Support: Clubs will need manual stopwatches, numbered bibs for every race participant, course markers and an adequate number of race volunteers/officials to ensure the safety of the skiers.

8.3.4 Guidelines for Organizing Other Club Events/Special Activities

Establish Objectives

- To create a positive competitive experience?
- To challenge children to test their ski skills against those of their peers?
- To encourage good ski technique?
- To encourage achievement through team effort?
- To provide a tournament component (one group/club will end up the overall winner)?
- Other objectives?

Organizational Tips

- Keep it simple.
- Keep children moving and avoid lapses in the day's schedule of activities, but provide them with opportunities to rest and acquire refreshments also.
- Decide on "cut-off" temperatures and alternative dates in case of cancellation due to weather problems.





- ❑ Enlist parents to help you organize the event, and provide them with appropriate information to work with. Establish a (parent) organizing committee and divide up the tasks among them.
- ❑ Talk to others who have held similar events to find out what works well and what doesn't work well.
- ❑ Incorporate variety into your program. Relays and sprints are favorites. For all formats, keep the competition distances short. Remember to emphasize speed and good technique at this age, *not* endurance.
- ❑ Children enjoy relays, but the drawback to this activity is that participants are often left standing in the cold waiting for their team mates to complete their leg. To get the best out of this format, keep the distances short and do not have more than three or four members per team.
- ❑ Points towards the overall team/club award/trophy should recognize the efforts of as many participants as possible. Recognize team effort, good technique and participation - not just winning.





8.4 Competition and the Community Coach

8.4.1 Tasks of a Community Coach – Regional Races

Coaches working with children in the FUNdamental stage of development are often concerned that they don't have the background to teach this part of the program. They therefore coordinate with their club head coach and/or other club junior racing team leaders for assistance and support. If your club is just getting started, however, and there isn't an established junior racing program to work with, you and your group of skiers can always tackle this challenge yourselves, and if you do you will discover that it is a very rewarding experience.

Early planning considerations should include:

- finding out what competitions will be held in your region and what the formats and race distances will be;
- selecting events that are appropriate for the age and skill level of the children you are working with. Use the “*CCC Athlete Development Grid*” (section 2.4) as your guide;
- selecting events that will be held within a reasonable distance of your home community. Children in this age range should not be travelling long distances to a competition unless their families are making the trip for older siblings anyway; and
- coordinating the trip for your athletes as a group (the learning experience will be less intimidating if your young skiers are accompanied by team mates with technical skills similar to their own).

Children should learn specific skills before they participate in a ski competition, the same as they learn specific skills before they earn a technique award. Points to cover should include the following:

- dressing appropriately for a competition;
- the equipment they will need for a competition (no-wax skis are not appropriate);
- becoming familiar with the course and stadium area before the race; what to look for; how to stay on the right course during the competition; how to decide which ski techniques to use on different sections of the course, etc.;
- where to pick up their bibs;
- how to test that their skis are working, and what to do if they are not;
- an appropriate warm-up procedure;
- when is the best time to go to the start area (not too early; not too late);
- the basic rules that apply to the race format that has been selected;
- the race procedures they need to understand with respect to the format that has been





selected. For example, if an interval start race has been chosen, the child needs to know how a “count down” works, how to stand in the start gate and what it means to have the field start at 15 second intervals. If a relay has been selected, they need to know the start procedures for a relay, how to make a correct exchange in the exchange zone, etc.

- there are two kinds of races:
 - ✓ **classic technique:** where the competitor can ONLY use diagonal stride, one-step double poling, double poling, step turn and downhill techniques. In this type of race skiers ski in the tracks provided; and
 - ✓ **free technique:** where the competitor can also use skating techniques. In this case, the course is usually groomed for skating, and there may not be any tracks set in which to classic ski.
- the importance of maintaining good ski technique during the race;
- an appropriate warm down procedure; and
- how to interpret results in terms of improving a “personal best”. That means that each child should evaluate their performance against their own goals for the event (did they ski a difficult downhill turn without falling, did they use herringbone technique where they should have used offset technique, etc.) rather than comparing their finish times against those of the other children in the field.

Coaching Tips:

- It is important to establish a minimum level of technical competency as a prerequisite for participation in a race.
- An established set of rules and regulations is used for all cross-country ski competitions in Canada.
- Coaches should, as a minimum, know the basic rules of their sport.
- The age categories at a cross-country ski competition should be the same as those used nationally for similar athlete development programs.
- Emphasize to parents that it is very important for their children to improve their performance through the development of good technique rather than endurance “training”.
- Traveling to a competition with their group or club “team” will be a highlight of the year for the young athletes in your program. It should be a rewarding “team building” exercise for your group as well as an opportunity for them to meet and mix with children their own age from other communities in the region.
- Trips should be coordinated to best utilize parental support.
 - ✓ Planning for the season should be done before the program starts up in the fall.
 - ✓ The responsibilities and expectations of the parents (with regard to supporting the program) should be made clear to them when they enroll their children.





- ✓ Tasks and responsibilities should be divided up early in the season. Consider individual situations while ensuring that a few parents aren't doing all the work. Some tasks do not require the parent to travel to a competition themselves.
- ✓ Special events/out of town competitions should be coordinated well in advance to allow parents to fit them into their schedules.
- ✓ If you plan ahead, you will get more support from the parents of your skiers.
- ❑ Create opportunities to teach sportsmanship, just as you would for teaching basic technique skills.
- ❑ If the temperature is colder than minus 15 degrees Celsius at race time, your athletes should miss this event.
- ❑ Teach your athletes to thank at least one official after the race is over.
- ❑ Provide your athletes with encouragement and positive feedback.
- ❑ Ask yourself these questions:
 - ✓ Did your team have fun?
 - ✓ Was it a positive experience for everyone?
 - ✓ Was I effective in saying something positive to each child before he/she left the event?

8.4.2 The Basic Rules of a Cross-Country Ski Competition

1. The competitor is responsible for arriving at the start and starting at the correct time.
2. Competitors must follow the marked course from start to finish and must pass all controllers and behave in a fair manner towards other competitors. A competitor who deviates from the designated course must return to the point of deviation before continuing.
3. Competitors have to cover the whole distance on their skis, wearing their assigned bib with the competitor number visible at all times and using only their own means of propulsion. Help from pacemakers (parents or coaches) and pushing are not allowed.
4. A competitor calls "track" if they wish to pass another competitor. This applies to athletes of ALL ages.
5. A competitor who is overtaken by another competitor must give way on the first demand except in sprint competitions and in marked zones. This applies in classic technique events even when there are two tracks, and in free technique (skating) events when the skier being overtaken may have to restrict their skating action. When overtaking, competitors must not obstruct each other.
6. Once the competitors enter a zone where corridors are marked they must remain in their chosen corridor unless they are overtaking another competitor.
7. The competitors must comply with the instructions of competition officials.





8. Any competitor withdrawing from the competition due to an accident or for any other reason must be reported to the officials at the Finish Line, and the bib returned.
9. Coaches and others are not allowed to run more than 30 meters beside the competitors.
10. A relay exchange is achieved by the arriving skier when they tap their hand on any part of their team mate's body, while both are in the relay exchange zone.
11. If an exchange contravenes the rules, both competitors must be recalled to the relay exchange zone where a correct handover must take place before the next competitor taking over can start.
12. The jury ensures that rules are enforced. They have the right to disqualify a competitor who has been found to have broken the rules





REFERENCES

Youngsters & Competition, Ski Cross Country, 1998, pp. 6.

NCCP Level 2 Technical Manual - Cross Country Skiing, 1995.

Parents Code of Conduct, Ski Cross Country, 1998, pp. 11.

Mundal, S. *How to Become a Good Senior Cross Country Skier*. C. Gaarder, translator. 1995.

BCR Program Leader Manual, 1996.

LeBlanc, J. and Dickson, L. *Straight Talk About Children & Sport*, 1997.

Scheier, A. *Skier Development Model Summary*, 1988.

CCC Rules and Regulations, 2004.

CCC Competition Model, May 2010.



SECTION 9 - TEACHING SKATING TECHNIQUE



Coaching Tip: The underlying rhythms of skiing manoeuvres are more important than the technical perfection of their components.

Source: Teaching Children to Ski



This section on Teaching Skating Technique is directed primarily at supporting you in your role as a coach working with children in the FUNdamentals stage of development. For a more comprehensive explanation on how to teach skating techniques to coaches and older athletes, refer to section 4 of the CCI-Learning to Train Reference Material.

9.1 Teaching Skating Technique

9.1.1 Skating Technique Checklists

To simplify the detection and correction of technique errors when you are out on the snow, a series of checklists has been developed.

Keep in mind that there are some aspects of good technique that are not included in these checklists - for example, smooth transitions and switching technique at the appropriate time. Skiers need to be relaxed, but at the same time have dynamic movements. They may have the proper body position and timing when skiing fast but give the overall impression of being stiff or tight – particularly in the shoulders and hips. The timing of the kicks and recovery movements may be correct but they also need to be dynamic. Determining if these factors are correct or not is much more of a judgement call than is commenting on body position, and thus doesn't fit into technique checklists easily.

Common Checkpoints

The following checkpoints are common to all skating techniques:

❑ Overall

- ✓ All techniques originate with the general athletic stance, modified for the specific technique being learned.
- ✓ Weight shifts fully from ski to ski.
- ✓ The skier is balanced on the gliding ski.
- ✓ Power is generated equally from both sides of the body.
- ✓ Motion of arms and legs is snappy and forceful.
- ✓ Hips and upper body stay generally oriented down the track.

❑ Lower Body

- ✓ The skier drives knee and hip forward allowing body to be vertically aligned over ski.
- ✓ The leg pushes to the side and slightly back.
- ✓ The gliding ski is flat for as long as possible before edging for push off.
- ✓ Pushes come from flexed hip, knee and ankle.
- ✓ Hips are forward over the glide foot.





□ Upper Body

- ✓ Poles are planted close to skis.
- ✓ The skier reaches high and forward with bent arms (elbows down and pointing slightly outwards).
- ✓ Shoulders are parallel to the ground.
- ✓ Compression occurs during the Double Pole-type motion.
- ✓ There is a slight forward body lean from the ankles.

Specific Checkpoints

The following checkpoints list the characteristics that are unique to each skating technique:

□ Offset

- ✓ Timing is keyed by a three-point landing (two poles are planted and new gliding ski touches snow at the same time).
- ✓ There is a Double Pole-type motion on the lead side, with staggered pole placement.
- ✓ The skier “falls” up the hill on the lead side, stepping onto a moving ski.
- ✓ Knee and hip are driven up the hill, and are aligned over the ski on both sides.
- ✓ The centre of gravity is constantly moving; there is no “lingering over glide ski” as in One Skate and Two Skate.
- ✓ The ankle, knee and hip joints are flexed as required by terrain.
- ✓ The skier executes a maximum leg push on each side, as with the other techniques.
- ✓ Leg push off (kick) is from an edged ski.
- ✓ At the completion of the leg push, the ski is raised slightly off the snow. The tip and tail of the ski leave the snow at the same time.
- ✓ Power comes relatively equally from the upper body and the pushing (kicking) leg.
- ✓ The upper body is dynamic, with a relatively shallow compression during the poling action.
- ✓ The follow-through of the arms and hands is short, and generally stops at or just past the hips (depending on slope of trail and skier speed).
- ✓ The upper body remains somewhat flexed forward, with back and upper body slightly rounded.
- ✓ Tempo increases as the slope of the hill increases.
- ✓ The slope of the hill dictates how wide a stance the athlete will take.

□ One Skate

- ✓ The skier executes a shallow Double Pole-type motion with each leg push.
- ✓ Arm and leg movements are the same on both sides of the body.





- ✓ The timing of the arm, body and leg movements is one of the most important features; the skier plants the poles (two points) when the legs are closest and just **before** stepping onto the new gliding ski (one point).
- ✓ The skier assumes a “high” position for the initiation of each Double Pole – hips are high, legs relatively straight, upper body is erect with slight forward lean.
- ✓ The upper body crunch and pole thrust are initiated together.
- ✓ Core muscles are engaged in the form of shallow upper body crunch.
- ✓ The skier begins to move over onto the new glide ski just before the arms reach the level of the hips.
- ✓ The Double Pole action and the skating push are complete as the new gliding ski hits the snow and the skier’s weight shift to that ski is completed.
- ✓ While the skier is gliding, the arms and trunk recover to the starting high position to initiate another Double Pole and skate.
- ✓ The Double Poling push initiated by the upper-body is energetic and powerful; the amount of trunk compression depends on terrain.
- ✓ The arm positioning throughout the poling motion is very similar to that in Double Poling in Classic technique.
- ✓ The follow-through of the arms and hands is short and stops just past the hips.
- ✓ Recovery of the arms after the completion of the Double Pole is rapid in order to position the arms forward to key the timing of the next side of the cycle.
- ✓ The recovery ski is raised only slightly off the snow.
- ✓ During the recovery of each leg, the foot passes underneath the hip of that side (feet come fairly close together).
- ✓ When placed on the snow, the gliding ski is pointed forward down the trail as much as the skier’s speed and the gradient of the track permit.

❑ Two Skate

- ✓ The skier executes a shallow Double Pole-type motion with each second leg push.
- ✓ Timing is the same as for One Skate, with poles being planted slightly before the recovery ski is placed on the snow.
- ✓ The technique is smooth and very rhythmic – akin to ballroom dancing.
- ✓ The method of propulsion on the poling side is identical to that of One Skate.
- ✓ The skier assumes a “high” position for the initiation of the Double Pole on the poling side – hips are high, legs relatively straight, upper body is erect with slight forward lean.
- ✓ As the Double Pole begins, the leg compresses and the hips are lowered slightly in order to load the leg and permit power to be generated as the leg extends.
- ✓ Core muscles are engaged in the form of shallow upper body crunches as the poling action is executed.
- ✓ Body compression results in a slight lowering of the body by the end of the poling motion.





- ✓ The return to the poling side is accomplished from the lower position with a skating push aided by the momentum of the arms swinging up, forward and over to the poling side.
- ✓ The arm recovery from follow-through to new pole plant is uninterrupted.
- ✓ The arm positioning throughout the Double Pole-type motion is very similar to that in Double Poling in Classic technique.
- ✓ The follow-through of the arms and hands is longer than in One Skate – past the hips or further, depending on speed, glide length and the skier's tempo.
- ✓ At the completion of the leg push, the left ski is raised slightly off the snow; the tip and tail of the ski leave the snow at the same time (if the binding is mounted in the correct position on the ski).
- ✓ During the recovery of each leg, the foot passes underneath the hip of that side (feet come fairly close together).
- ✓ The glide on the left and right skis is consistent.

❑ **Free Skate**

- ✓ The skier remains low with pronounced flexion at knees and ankles.
- ✓ Upper body remains low similar to the tuck position.
- ✓ The skier maintains good balance and makes a complete weight shift from ski to ski.
- ✓ The arms swing from side to side (or are in front of face depending on speed).



SECTION 10 - PRACTICE COACHING SESSION



Coaching Tip: If children do not have good technique, they will become discouraged with the hard work required to keep up with others.

Source: How to Become A Good Senior Cross-Country Skier



10.1 Self-Assessment Sheet

Practice Coaching #2: Skill Progression, Intervention and Communication

Criteria	Yes	No
Skill Progression		
✓ The progression for skill development is appropriate for the age/ability of the participants		
✓ Coach focuses on the appropriate key points for the skill to be developed		
✓ Coach adjusts the activity for more advanced and less advanced abilities within the group		
✓ Comments/suggestions:		
Intervention		
✓ Coach scans the entire group constantly and intervenes with a variety of participants		
✓ Coach looks for input/feedback from the participants		
✓ Correction or reinforcement is clear and a visual is provided		
✓ Correction or reinforcement is brief and participant returns quickly to activity		
✓ Coach focuses on communicating what to do (not what NOT to do)		
✓ Comments/suggestions:		
Communication		
✓ Coach speaks in a calm tone of voice (i.e. does not yell at the participants)		
✓ Coach uses language that the children can easily understand		





Criteria	Yes	No
✓ Coach refrains from the use of foul language		
✓ Words and body language used in the correction or reinforcement are positive *		
✓ When praise is given, it is specific, not general (e.g. "you are doing ___ well", not "nice one!")		
✓ Coach acts and speaks with enthusiasm *		
✓ Comments/suggestions:		

* This looks like: smiles; nods in the affirmative.

* This sounds like: cheers; "Sally, you did ___ very well. Way to go!"; or "Johnny, I see that you are improving at ____. Great job!"

* This feels like: high fives; safe pats on the back; a hand shake of congratulations (use these only if the child is clearly comfortable with physical contact from you).

Counting Interventions during the Activity	Number
✓ Duration of the activity in minutes (when participants are practicing, excluding explanation and demonstration)	
✓ Total number of interventions with the entire group	
✓ Total number of interventions with individual participants	
✓ Total number of different participants with whom the coach intervened	

Remember, more is not necessarily better. The total numbers are only to give you an indication of how often you are intervening and whether you are moving among the group or focussing only on certain participants.





Self-Assessment Sheet (working copy #1)

Practice Coaching #2: Skill Progression, Intervention and Communication

Criteria	Yes	No
Skill Progression		
✓ The progression for skill development is appropriate for the age/ability of the participants		
✓ Coach focuses on the appropriate key points for the skill to be developed		
✓ Coach adjusts the activity for more advanced and less advanced abilities within the group		
✓ Comments/suggestions:		
Intervention		
✓ Coach scans the entire group constantly and intervenes with a variety of participants		
✓ Coach looks for input/feedback from the participants		
✓ Correction or reinforcement is clear and a visual is provided		
✓ Correction or reinforcement is brief and participant returns quickly to activity		
✓ Coach focuses on communicating what to do (not what NOT to do)		
✓ Comments/suggestions:		
Communication		
✓ Coach speaks in a calm tone of voice (i.e. does not yell at the participants)		
✓ Coach uses language that the children can easily understand		





Criteria	Yes	No
✓ Coach refrains from the use of foul language		
✓ Words and body language used in the correction or reinforcement are positive *		
✓ When praise is given, it is specific, not general (e.g. "you are doing ___ well", not "nice one!")		
✓ Coach acts and speaks with enthusiasm *		
✓ Comments/suggestions :		

* This looks like: smiles; nods in the affirmative.

* This sounds like: cheers; "Sally, you did ___ very well. Way to go!"; "Johnny, I see that you are improving at ____. Great job!"

* This feels like: high fives; safe pats on the back; a hand shake of congratulations (use only if the child is clearly comfortable with physical contact from you)

Counting Interventions during the activity	Number
✓ Duration of the activity in minutes (when participants are practicing, excluding explanation and demonstration)	
✓ Total number of interventions with the entire group	
✓ Total number of interventions with individual participants	
✓ Total number of different participants with whom the coach intervened	

Remember, more is not necessarily better. The total numbers are only to give you an indication of how often you are intervening and whether you are moving among the group or focussing only on certain participants.





Self-Assessment Sheet (working copy #2)

Practice Coaching #2: Skill Progression, Intervention and Communication

Criteria	Yes	No
Skill Progression		
✓ The progression for skill development is appropriate for the age/ability of the participants		
✓ Coach focuses on the appropriate key points for the skill to be developed		
✓ Coach adjusts the activity for more advanced and less advanced abilities within the group		
✓ Comments/suggestions:		
Intervention		
✓ Coach scans the entire group constantly and intervenes with a variety of participants		
✓ Coach looks for input/feedback from the participants		
✓ Correction or reinforcement is clear and a visual is provided		
✓ Correction or reinforcement is brief and participant returns quickly to activity		
✓ Coach focuses on communicating what to do (not what NOT to do)		
✓ Comments/suggestions:		
Communication		
✓ Coach speaks in a calm tone of voice (i.e. does not yell at the participants)		
✓ Coach uses language that the children can easily understand		





Criteria	Yes	No
✓ Coach refrains from the use of foul language		
✓ Words and body language used in the correction or reinforcement are positive *		
✓ When praise is given, it is specific, not general (e.g. "you are doing ___ well", not "nice one!")		
✓ Coach acts and speaks with enthusiasm *		
✓ Comments/suggestions :		

* This looks like: smiles; nods in the affirmative.

* This sounds like: cheers; "Sally, you did ___ very well. Way to go!"; "Johnny, I see that you are improving at ____. Great job!"

* This feels like: high fives; safe pats on the back; a hand shake of congratulations (use only if the child is clearly comfortable with physical contact from you)

Counting Interventions during the activity	Number
✓ Duration of the activity in minutes (when participants are practicing, excluding explanation and demonstration)	
✓ Total number of interventions with the entire group	
✓ Total number of interventions with individual participants	
✓ Total number of different participants with whom the coach intervened	

Remember, more is not necessarily better. The total numbers are only to give you an indication of how often you are intervening and whether you are moving among the group or focussing only on certain participants.





10.2 Facility Safety Checklist



Facility: _____ Date: _____

Inspected by: _____

Item	Adequate	Inadequate	Corrective Measures*	Observations
Practice Area				
Ski Trails				
Daylodge and Waxing Area				
Equipment				
First Aid Kit & Procedures				
Others				

**Ensure corrective measures are taken if safety standards are inadequate.*







Facility Safety Checklist (working copy)



Facility: _____ Date: _____

Inspected by: _____

Item	Adequate	Inadequate	Corrective Measures*	Observations
Practice Area				
Ski Trails				
Daylodge and Waxing Area				
Equipment				
First Aid Kit & Procedures				
Others				
<i>*Ensure corrective measures are taken if safety standards are inadequate.</i>				







10.3 Assessment Tools for Community Coaches

Great coaches are continually looking for ways to improve. In order to be able to tell if you are improving, you will need to ask yourself and others “How am I doing?”

The following assessment tools are provided to help you check how you are doing as a community coach. You will see that they are clearly focused on your ability to provide a fun and safe environment in which children can learn through playing a sport. You will use some of these tools during your practice coaching sessions in the workshop, but you may also choose to use them throughout your season by asking a trusted parent or an assistant to fill them in for you, or by filling them in yourself.

A few words on receiving feedback from others:

- When you ask others for their feedback, remember to listen attentively to their observations and comments without expressing defensiveness. You may not always agree with their observations, but you have asked for the input, so it deserves to be considered with an open mind.
- If possible, try to gather feedback from more than one person, and look for commonalities among their comments.

It is your choice which comments you decide to implement and what you choose to ignore. The power to change your behaviours remains yours alone.

Coaching Tip:

The best way to encourage children/youth to receive your coaching feedback positively and improve their abilities accordingly is to model this behaviour. Coaches who regularly ask for feedback and who actively seek to improve their intervention skills are showing the children they coach that it is good to aim at getting better in whatever you do.

It is very true that a picture is often worth more than words alone.





10.3.1 Are the Children Having Fun?

While the children were participating, the following was observed:
(Tick once in the shape for each time it was observed)



A child smiled



A child laughed or giggled

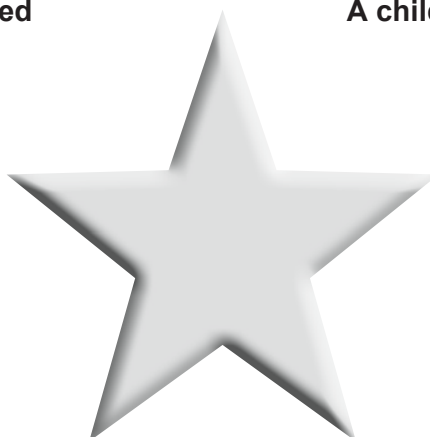

A child encouraged another
(cheer, pat on back, high five)

YOUR SELF-ESTEEM METER (count your ticks)

***Today, your coaching helped make a child feel good about
himself/herself _____ times.***

Way to go!





10.3.3 How Are You Acting During Competitions?

While the children were participating, the following was observed:
(Tick once in the shape for each time it was observed)



**The coach spoke harshly
or yelled at a child**



**The coach encouraged a child
(smile, cheer, pat on back, high five)**

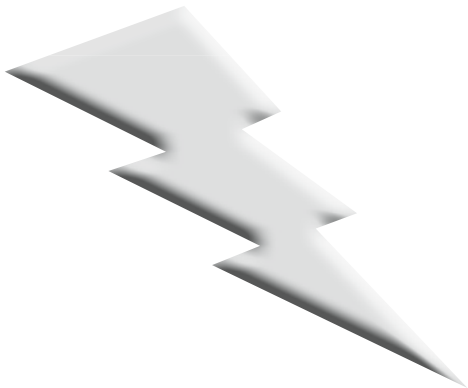

**The coach commented negatively
about or to the official**



**A child smiled,
laughed or cheered**





REFERENCES

Some images and pictures contained in this document are the property of CARDISPORT or HEMERA TECHNOLOGIES INC. and are copyrighted.





SECTION 11 - EVALUATION



Coaching Tip: Fluent action and confidence on skis will encourage children when they reach the developmental stage where they are self-conscious about their appearance in front of others.

Source: CCBC Ski League Manual



11.1 NCCP Community Coaching Certification Process

The NCCP is a competency-based program. This program trains coaches, and then permits trained coaches to become certified. Certification is based on demonstrating abilities to “do” certain things that are deemed important for meeting the needs of those being coached, thereby creating an environment that will both optimize athletic development and encourage individuals to make a life-time commitment to sport and physical activity.

In the new NCCP system a coach is described as:

- In Training** - when the coach has completed some of the required training for a context.
- Trained** - when the coach has completed all required training for a context.
- Certified** - when the coach has completed all evaluation requirements for a context.

The Introduction to Community Coaching and Community Coaching workshops provide you with the basic training you require in order to coach children in the Active Start and FUNdamental stages of growth and development.

- When you have completed the first workshop (Introduction to Community Coaching) you will be designated a “community coach in training”.
- When you have completed the second workshop (Community Coaching) you will be designated a “trained community coach”.
- At the end of the second workshop you will have completed most of the steps required for certification.
- Community Coaching certification is a prerequisite for entry into the next step in the NCCP progression (i.e. attendance at the first CCI workshop – the L2T (Dryland) workshop).
- Once you have acquired a particular status in the NCCP progression (i.e. community coach “in training”, “trained” community coach and “certified” community coach, it will be recorded on the Coaching Association of Canada (CAC) database as part of your coaching record.
- Your certification status will be valid for a period of five years, and can be extended by completing designated development activities, such as coaching seminars, practical assignments and additional coaching workshops.
- Your certification status can be revoked if you contravene the CCC Coaches Code of Conduct or NCCP Code of Ethics.

A complete explanation of the Community Coaching certification process, and the forms used in this process are available on the Cross Country Canada website. In addition, the following chart





identifies the key outcomes and evaluation components which comprise Community Coaching certification:

Outcomes	Evaluation Components
1. The coach makes ethical decisions.	a. Code of Conduct. The coach signs one copy of the CCC Coaches Code of Conduct and submits it to the Facilitator. b. Ethics Evaluation. The coach successfully completes the “Making Ethical Decisions (MED)” on-line evaluation from the Coaching Association of Canada.
2. The coach plans a safe, effective activity/ practice session.	c. Emergency Action Plan (EAP). The coach completes an appropriate EAP for an activity session and submits it to the Facilitator. d. Practice Planning. The coach prepares an appropriate written activity/practice plan and submits it to the Facilitator.
3. The coach analyzes ski technique.	e. Identifies Techniques. The coach correctly identifies the basic characteristics of common ski techniques. f. Critiques Technique. The coach correctly identifies aspects of basic techniques that require improvement, and correctly prescribes changes that will result in improvement.
4. The coach provides appropriate support to athletes.	g. Facility Safety. The coach completes a Facility Safety Checklist for a practice session and submits it to the Facilitator. h. Leading a Practice. The coach successfully leads a practice session placing an appropriate emphasis on key teaching principles and safety factors.
5. The coach supports athletes at a “special activity”.	i. Experience at an Age-Appropriate “Special Activity”. The coach supports a group of skiers at a Season Wind-up, Bunnyrabbit and/or Jackrabbit Fun Day, Ski Tournament or some other age-appropriate “special activity”.
6. The coach manages a skill development program for athletes in the FUNdamental stage of development.	j. Community Coaching Certification Test. The coach successfully completes a knowledge test demonstrating his/her understanding of the key coaching concepts covered in the community coach program.





7. The coach has personal technical competence.	<p>k. Technique Evaluation. The coach demonstrates a basic level of technical skill in each of the techniques covered in the Community Coaching workshop.</p> <p>Note: Coaches with a significant reason for being unable to complete the technical skill requirements have an opportunity to apply for an exemption.</p>
8. The coach has general coaching experience.	<p>l. Coaching Experience. The coach: completes one season of coaching; prepares for, assists with and/or leads a minimum of six activity/practice sessions (minimum 20 hours); and receives satisfactory reviews from the parents and athletes.</p>

11.1.1 NCCP Community Coaching Certification Steps

To acquire Community Coaching certification in cross-country skiing, you must successfully complete the following:

- ICC Workshop and assignments (see the checklist below).
- CC Workshop.
- Community Coaching Experience Form.
- Community Sport Making Ethical Decisions (MED) Online Evaluation.

Your Current NCCP Status?

To find out your current NCCP status, access your transcript details on the Coaching Association of Canada (CAC) website at: www.coach.ca. Your transcript provides a summary of the workshops and “experiences” in which you have been trained and evaluated. To do this, click on the link to “Check Certification Status”. Next, enter your Certification Card number (CC#) and your last name. If you do not know your CC#, you can request it via coach@coach.ca.

If you discover there is a problem with your certification records, please contact your Division Coaching Coordinator.

Community Coaching Experience Form

If you haven’t already done so, follow the instructions on the attached form, and, when it is completed, forward it to your Division Coaching Coordinator.





Community Sport Making Ethical Decisions (MED) Online Evaluation

Before you begin the evaluation process you will need:

- Your CC#.
- An account with the NCCP Database:
 - ✓ If you have your CC# but do not have an account set up with the NCCP Database, contact the NCCP database via email at coach@coach.ca.
 - ✓ If you encounter any problems signing up or do not remember your username and password, contact the NCCP Database Team at coach@coach.ca.
 - ✓ Remember to include your full name, CC# and e-mail address in the correspondence.
- The “Six Steps of Making an Ethical Decision”. Write them down! This information will help you complete your evaluation successfully.

Please be advised:

- The first time you access the evaluation, you will be prompted to confirm your enrolment. Click on the “Yes” button.
- The evaluation process will take at least one hour to complete. You may stop at any time and continue when it is more convenient without losing the work you have already done.
- You will have two opportunities to complete the evaluation successfully. If are unsuccessful both times, you will be required to participate in a “Making Ethical Decisions Module” in order to access the online evaluation again.

When you are ready to take the Making Ethical Decisions Online Evaluation for Community Sport, visit: <http://evaluation.coach.ca/course/view.php?id=53>.

Your Certification Checklist

- ICC Workshop**
 - ✓ Sign and submit Code of Conduct to Facilitator.
 - ✓ Complete and submit Emergency Action Plan to Facilitator.
- Between Workshops**
 - ✓ Develop a written Activity Plan or Practice Plan and use it with your group.
 - ✓ Complete one season of coaching. Prepare for, assist with and/or lead a minimum of six sessions (minimum 20 hours).
 - ✓ Support/lead a group of skiers at a Season Wind-up, Bunnyrabbit and/or Jackrabbit Fun Day, Ski Tournament or some other age-appropriate “special activity”.





❑ **CC Workshop**

- ✓ Submit written Activity Plan or Practice Plan to Facilitator.
- ✓ Complete and submit Facility Safety Checklist to Facilitator.
- ✓ Personal technique competence evaluated.
- ✓ Lead a practice session and receive feedback.
- ✓ Technique analysis skills evaluated.
- ✓ Complete Community Coaching Certification Test and submit to Facilitator.
- ✓ Submit NCCP Community Coaching Experience Form (evidence of 20 hrs of coaching and support for a group of skiers at a “special activity”) to Facilitator.

❑ **Post CC Workshop**

- ✓ Complete the Coaching Association of Canada’s (CAC) “Making Ethical Decisions” on-line evaluation. This step can be completed at any time following the Community Coaching workshop.
- ✓ Participants who have not completed their other certification steps by the end of the Community Coaching workshop will have an opportunity to complete the process afterwards provided this is done within 12 months of the date of which the CC workshop was held. Options for completing the unfinished tasks include:
 - submitting their NCCP Community Coaching Experience Form directly to their Division Office; and/or
 - submitting other outstanding forms to the Facilitator for review; and/or
 - arranging an evaluation opportunity with a qualified coach or Facilitator.
- ✓ The cost of the Facilitator reviewing and processing forms/documents following the CC workshop is included with the original honorarium.
- ✓ Possible costs relating to a subsequent on-snow evaluation are the responsibility of the club or individual.





11.2 Community Coaching Flowchart

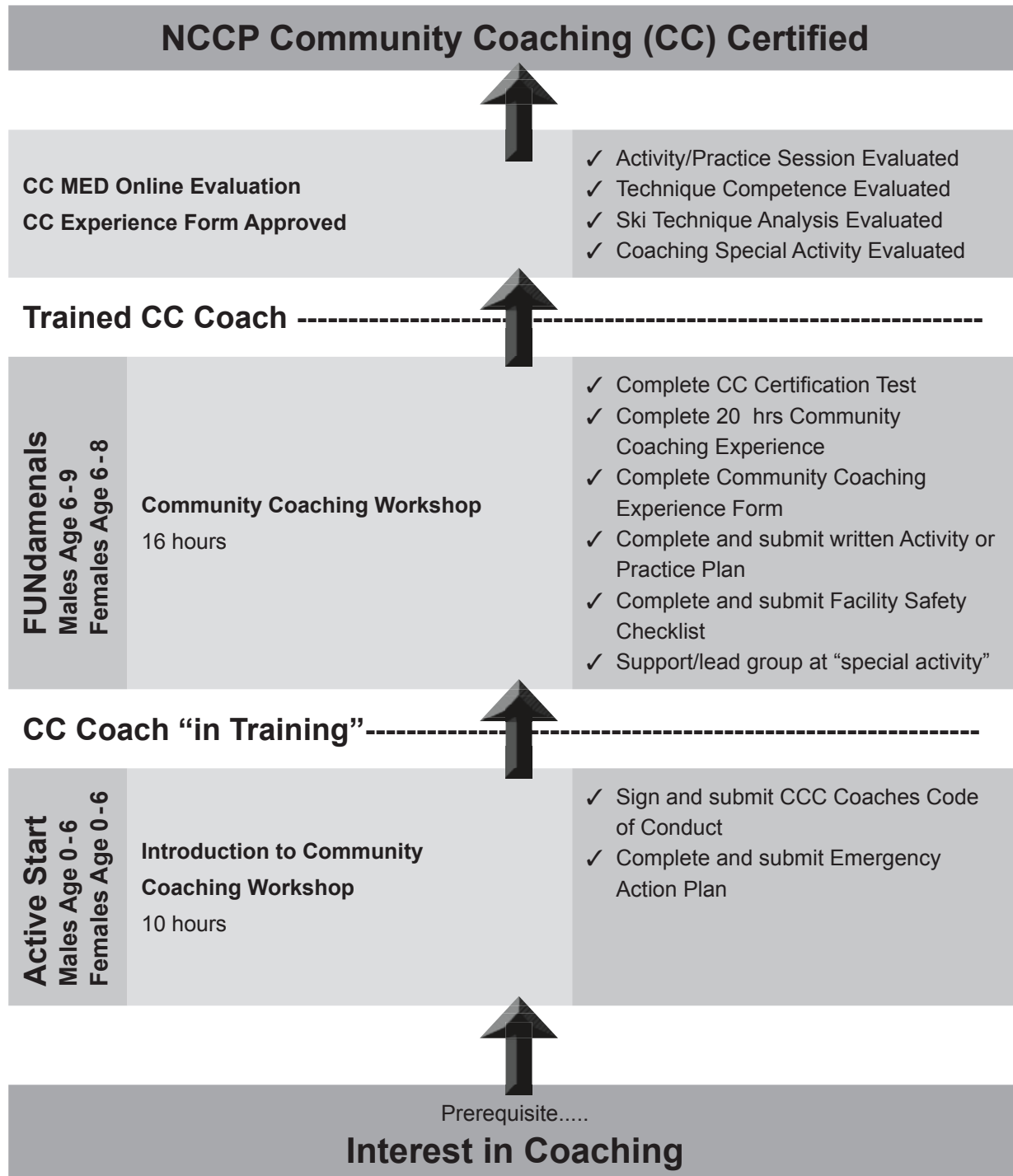



11.3 Recommended Training Standards for Coaches

One of the underlying principles of the NCCP is that “every child deserves a competent coach.”

All individuals coaching children should have a minimum of 25 hours of training to prepare them for their responsibilities. This would include both the Introduction to Community Coaching (ICC) workshop and the Community Coaching (CC) workshop.

Help keep kids in cross-country skiing by being prepared!

- ❑ **Active Start.** The minimum (required) training for coaching children in the “Active Start” stage of development is the ICC level (completion of the ICC workshop).
- ❑ **FUNDamentals.** The minimum (required) training for coaching children in the “FUNDamentals” stage of development is the CC level (completion of the CC workshop).
- ❑ **Learning to Train.** The minimum (required as of January 1st, 2012) training for coaching children in the “Learning to Train” stage of development is the CCI Learning to Train level, which involves completing CC certification and the CCI Learning to Train (Dryland and On-Snow) workshops.
- ❑ **Training to Train.** The minimum (January 1st, 2014) training for coaching athletes in the “Training to Train” stage of development is the CCI Training to Train level, which involves completing CCI Learning to Train program requirements and the CCI Training to Train (Dryland and On-Snow) workshops.







11.4 NCCP Community Coaching Certification Test



Date of Workshop: _____ Location: _____

Facilitator's Name: _____

Coach's Name: _____

The following is your "Community Coaching Certification Test". Please circle T (true), or F (false), OR the appropriate letter for each of these statements:

- 1) At six years of age children should be developing fundamental movement skills through specialization in one sport, rather than a variety of activities. T F

- 2) Athletes will never reach their optimal or genetic potential if fundamental movement skills and fundamental sport skills are not established before what age? A B C
 - A. Seven (female) and eight (male) years of age.
 - B. 11 (female) and 12 (male) years of age.
 - C. 14 (female) and 16 (male) years of age.

- 3) The first of two windows for optimal development of speed are: A B C
 - A. Six to eight years (females) and seven to nine (males).
 - B. Eight to 11 years (females) and nine to 12 years (males).
 - C. 13 to 15 years (females) and 14 to 16 years (males).

- 4) Basic motor abilities can be developed through games; therefore, during practice sessions for children six and seven years of age most activities should take the form of games. T F

- 5) In summary, the guide to ethical decision making is: T F
 - ✓ gather the facts;
 - ✓ determine if the situation is legal or ethical;
 - ✓ consider what might influence how you see the situation; and
 - ✓ use the NCCP Code of Ethics to guide decision-making.

- 6) Studies indicate that coaches who work with young participants in sport have little influence in helping them develop positive self-esteem. T F

- 7) The development of balance on skis is helpful in the development of good ski technique, but not essential, and is commonly over-emphasized. T F





- 8) A ski playground is only useful for teaching technique to children under six years of age. T F
- 9) In Diagonal Stride, a skier is on one weighted foot at a time. T F
- 10) The “scooter drill” is a good game to use to improve weight shift, but only if it is done correctly. T F
- 11) In Diagonal Stride, when the push foot returns forward, it touches the snow: A B C
A. Behind the heel of the glide foot.
B. Off to the side of the pole.
C. Beside or slightly in front of the glide foot.
- 12) In Double Poling, when you start to plant your poles, your hips should be aligned: A B C
A. Over the ball of the foot.
B. Over the heel.
C. Behind the heel.
- 13) In Offset technique, the skier's weight shifts quickly from ski to ski. T F
- 14) In Skating Technique, the kick leg: A B C
A. Pushes out to the front of the body.
B. Pushes out to the side of the body.
C. Pushes out to the back of the body.
- 15) In Skating Technique, the size of the “V” made by the skis should be as wide as possible. T F
- 16) In One-Skate Technique, a double pole plant occurs with each leg push. T F
- 17) In Two-Skate Technique, there is/are: A B C
A. One arm push for each leg push.
B. One arm push for every two leg pushes.
C. Two arm pushes for every leg push.
- 18) Skiing without poles is a good way to develop balance and weight transfer. T F





- 19) Six to eight sessions a season are sufficient to keep a nine year old child interested in the sport and provide him/her with a good foundation of sport specific skills. T F
- 20) Children under ten do not need “special activities” incorporated into a program in order to keep them interested in the sport. T F
- 21) Practice sessions held during the fall can provide a positive team-building experience for the skiers in your program. T F
- 22) When praising a skier on a technical skill, the praise should be general, not specific. T F
- 23) When giving feedback on a skill, a coach should emphasize what not to do. T F
- 24) When teaching a skill it is important to emphasize all aspects of the skill before letting the skier practice it. T F
- 25) An athlete-centred sport environment means that the coach does everything for the skier, i.e. waxes their skis for them all the time. T F
- 26) The camber is the surface texture/finish that allows a ski to glide better on the snow surface. T F
- 27) When selecting classic skis it is common to pick skis that are too soft. It is best to err on the side of skis that are slightly too stiff than skis that are slightly too soft. T F
- 28) The quality in the running surface in the ski base deteriorates with use and from time to time the ski should be re-scraped or re-ground. T F
- 29) Formal skill instruction sessions are not enough to keep a child involved in sport – they require an appropriate ratio of “game-time” (age-appropriate FUNdamental competitive activities) to challenge themselves against their peers. T F
- 30) As a general principle, children should get their first exposure to competitive activities in the context of games during practice sessions. When they learn the skills to manage one level of competitive activity they are ready to graduate to the next one. T F

Please submit this test to the Facilitator when it has been completed.







11.5 NCCP Community Coaching Experience Form



NCCP CC #: _____ Last Name: _____

First Name: _____ Street: _____

City: _____ Prov.: _____

Postal Code: _____ Tel: _____ Email: _____

Date of Birth (d/m/y): _____ Male or Female English or French
(circle one) (circle one)

1. Complete one season of coaching experience. Prepare for, assist with and /or lead a **minimum** of six activity/practice sessions including one "special activity". **Minimum** of 20 hours of coaching including preparation time.

Beginning date: _____ Ending date: _____

Age range: _____ Name of Ski Club: _____

Receive a satisfactory evaluation from a club leader (i.e. Club Head Coach, SDP Programmer) who has gathered comments from skiers and parents involved with the program).

2. Assist/lead a group of skiers at a Season Wind-up, Ski Tournament or some other age-appropriate "special activity".

Date, name and location of "Special Activity": _____

Receive a satisfactory evaluation from a club leader (i.e. Club Head Coach, SDP Programmer) who has gathered comments from the skiers and parents involved in the activity.

Please sign the following statement and have it verified by a leader from your ski club (Head Coach, SDP Programmer, Club Executive):

I, _____ have completed the NCCP Community Coaching experience requirements for cross-country skiing.

Date Signature of Applicant

I verify that _____ has completed the NCCP Community Coaching experience requirements for cross-country skiing.

DATE Signature of Club Official

Please forward to your Division Office







11.6 Evaluation Form



Community Coaching Workshop Cross-Country Skiing

Date of Workshop: _____ Location: _____

Facilitator's Name: _____

Please fill in this form and hand it in to the Facilitator before you leave. Your comments are important to the ongoing development of the National Coaching Certification Program.

Please answer the following:

The workshop gave me a better understanding of why sport experiences are important for children.

1	2	3	4	5
<i>Strongly disagree</i>				<i>Strongly agree</i>

The workshop provided me with a better understanding of the growth and development characteristics of children and the implications for coaching different age groups.

1	2	3	4	5
<i>Strongly disagree</i>				<i>Strongly agree</i>

Having completed the workshop I can more effectively respond to an ethical situation in a way that is consistent with the NCCP values and philosophy.

1	2	3	4	5
<i>Strongly disagree</i>				<i>Strongly agree</i>

I developed a better understanding of the key teaching points and progressions for classic techniques.

1	2	3	4	5
<i>Strongly disagree</i>				<i>Strongly agree</i>

I developed a better understanding of the key teaching points and progressions for skating techniques.

1	2	3	4	5
<i>Strongly disagree</i>				<i>Strongly agree</i>





Please answer the following questions:

What sections of the workshop did you find particularly useful?

Would there be anything you would like to see added to this workshop?
If so, what would it be?

Are there any additional comments or suggestions you wish to add?

Thank you for your feedback, and best wishes in your coaching.





APPENDIX A - COACHING ATHLETES WITH A DISABILITY



Coaching Tip: Every child deserves a competent coach.
Source: National Coaching Certification Program



A.1 Introduction

Cross-country skiing is a sport that can be enjoyed by all regardless of the type of disability - physical or intellectual.

To a large extent, everything in Cross Country Canada's able-bodied Long Term Athlete Development model is applicable to athletes with a disability as well. It is the starting point for the development of all cross-country skiers. Therefore, this section focuses solely on factors that need to be considered when working with athletes with a disability - either modifications or additional factors that need to be addressed.

Cross Country Canada, its divisions and clubs provide programming for both athletes with congenital physical disabilities and athletes with physical disabilities acquired later in life. In addition, sport specific technical training is provided to coaches who work with athletes with intellectual disabilities.

A.1.1 Coaching Athletes with a Disability

Individuals with a disability need lifelong access to trained and knowledgeable teachers and coaches when they engage in physical activity and sport for their health and enjoyment, particularly if they want to learn a new sport. For this reason, Cross Country Canada's NCCP program includes a coach education stream specifically for training and certifying coaches for this purpose.

Teachers and coaches working with athletes in the Active Start, FUNdamentals and Learning to Train stages need to be versed in sensitization tips and techniques on introducing athletes with a disability to sport situations. It is essential for them to be able to create a positive learning environment and adapt equipment, skills and rules in order to get individuals involved and keep them involved in sport.

Coaches working with athletes in the Training to Train, Learning to Compete and Training to Compete stages need: to be specialists in working at the developmental level; to understand how to adapt physiological activities and skill development; and to have a good knowledge of classification and competition rules.

Coaches training athletes at the Training to Win stage need to have: advanced sport specific technical knowledge; knowledge of adaptations for physiological and skill development; knowledge of disability characteristics relating to cross-country skiing and the interface with equipment if specialized equipment is required; and knowledge of IPC classification and competition rules in order to be effective in their role.

A.1.2 Glossary of Terms

- ❑ **Access** refers to the availability of programs, services and facilities to persons with a disability. It also refers to attitudes and support systems that ensure that athletes with a disability can be participating and contributing members of communities. A program, service, or facility is said to be accessible if it can be utilized by someone with a disability.





- ❑ **Accessibility** refers to the promotion of the functional independence of individuals through the elimination of barriers.
- ❑ **Acquired Disability** means the disability was not present at birth.
- ❑ **Canadian Paralympic Committee (CPC)** refers to the national governing body of the Paralympic Movement in Canada. The CPC delivers programs that strengthen its objectives, including sending Canadian teams to the Paralympic Games. It also empowers persons with physical disabilities, through sport, at all levels. To view the CPC website go to www.paralympic.ca.
- ❑ **Congenital Disability** means the disability was present at birth.
- ❑ **Disability** is a reduction of functional ability resulting from impairment. Additional information on the different types of disabilities can be found on the IPC website at www.paralympic.org.
- ❑ **Impairment** is an anatomic, physiological or functional loss, which may or may not result in a disability.
- ❑ **Inclusive** (in the context of this section) means everyone can participate equitably.
- ❑ **Intellectual Disability** refers to a condition of arrested or incomplete development of the mind characterized by impairment of skills and overall intelligence in areas such as cognition, language, and motor and social abilities. Although reduced level of intellectual functioning is the characteristic feature of this disorder, the diagnosis is made only if it is associated with a diminished ability to adapt to the daily demands of the normal social environment. An intellectual disability can occur with or without any other physical or mental disorders.
- ❑ **International Paralympic Committee (IPC)** refers to the global governing body of the Paralympic movement. The IPC organizes both the Paralympic Winter Games and Paralympic Summer Games and serves as the International Federation for nine sports, for which it supervises and co-ordinates a World Championships and other competitions. The IPC is committed to enabling Paralympic athletes to achieve sporting excellence and to developing sport opportunities for all persons with a disability from beginner to elite levels. In addition, the IPC aims to promote the Paralympic values which include courage, determination, inspiration and equality. To view the IPC website go to www.paralympic.org.
- ❑ **Peak Strength Velocity (PSV)** is the maximum rate of increase in strength during the growth spurt. The age of maximum increase in strength can be described as the age at PSV.
- ❑ **Peak Weight Velocity (PWV)** is the maximum rate of increase in weight during the growth spurt. The age of maximum increase in weight can be described as the age at PWV.
- ❑ **Physical Disability** refers to difficulty moving or coordinating a part of the body, muscle weakness, tremors and, in extreme cases, paralysis in one or more parts of the body. Physical disabilities can be congenital, such as muscular dystrophy; or acquired, such as tendonitis. Physical disabilities affect an individual's ability to:
 - ✓ perform manual tasks, such as hold a pen, grip and turn a key, type on a keyboard, click a mouse button or twist a doorknob;





- ✓ control the speed of one's movements;
 - ✓ coordinate one's movements;
 - ✓ move rapidly;
 - ✓ experience balance and orientation;
 - ✓ move one's arms or legs fully, e.g., climb stairs;
 - ✓ move around independently, e.g. walk any distance, easily get into or out of a car, stand for an extended period;
 - ✓ reach, pull, push or manipulate objects; and/or
 - ✓ have strength or endurance.
- ❑ **Sighted Guide** is another athlete who skis with an athlete with blindness/visual impairment. In a competition guides are required to wear a bright bib with the same number as the visually impaired athlete they are guiding, and to guide them by voice only except in very specific situations where the race rules allow otherwise.
- ❑ **Sit-skis** are two cross-country skis with an accessible chair attached to the top of them. They are used by athletes who have spinal cord injuries, leg weaknesses or amputations.





WORDS WITH DIGNITY

The following terms are suggested to describe persons with disabilities.

INSTEAD OF	USE	INSTEAD OF	USE
disabled, handicapped or crippled	person with a disability or people with disabilities	physically challenged	person with a physical disability
crippled by, afflicted with, suffering from or deformed	person who has or person with	mental patient, mentally ill, mental or insane	person who has or person with (e.g. a mental illness or schizophrenia)
lame	person who has a mobility impairment	learning disabled or learning difficulty	person with a learning disability
confined, bound or restricted to a wheelchair	person who uses a wheelchair	visually impaired (as a collective noun) or blind	people who have a visual impairment
deaf and dumb, deaf, deaf mute or hearing impaired	person who is (e.g. deaf or hard of hearing)	disabled sport	sport for athletes with disabilities
retarded or mentally retarded	person with an intellectual disability	disabled community	disability community
spastic	person with cerebral palsy		

Remember, appropriate terminology changes with the times.

If in doubt, ask.





A.2 Important Factors Influencing the Development Process for Athletes with a Physical Disability

Research points to a number of key factors that influence the development of athletes with a disability. Building programs around these factors will help athletes experience both optimal development in their chosen sport and lifelong involvement in physical activity.

Types of Disability

Athletes may be born with a disability (i.e. congenital disability), or they may acquire a disability later in life.

- ❑ **Congenital Disability.** Children with a congenital disability may not have the same opportunity to learn FUNdamental movement skills as able-bodied children because they may not have the same opportunities for vigorous, physical play during their early years (the Active Start stage of development). This is sometimes due to long periods of hospitalization and the lack of suitable physical education programs, but it may also be due to parents or caregivers being overly protective, a situation that can also occur with an acquired disability. It should be recognized that children with congenital disabilities progress through LTAD stages the same way, and with similar timelines, as able-bodied children.
- ❑ **Acquired Disability.** Athletes who acquire their disability later in life, and are then introduced to cross-country skiing, will likely have progressed through the first three or four LTAD stages already, depending on when their disability occurred. They may have to relearn some FUNdamental movement skills with their new body, but they can expect to progress through these skills at a much faster rate than the first time they went through them.

Athletes with a disability pass through the same stages as able-bodied athletes, although the ages and rate of progress may differ.

Source: No Accidental Champions

The Ten Year Journey

Athletes with congenital disabilities follow a development pathway similar in length to that required for able-bodied athletes, while athletes with a disability acquired later in life may reach the international level as a competitor in less than ten years post injury, depending on their level of development pre-disability.

The FUNdamentals

Children with a disability should acquire FUNdamental movement and sport skills (physical literacy) through fun and games, the same way able-bodied athletes do. This needs to be achieved prior to puberty.





Children have difficulty acquiring these skills because:

- ❑ Overly protective parents, caregivers, rehabilitation facility staff, teachers and coaches shield them from the bumps and bruises of childhood play.
- ❑ Most school systems don't have well-developed, adapted physical education programs.
- ❑ Coaches/programs are reluctant to include children with a disability in their activities because of a lack of resources and a lack of knowledge about how to integrate them.
- ❑ Creativity and extra effort are required to integrate an individual with a disability into a group activity where FUNdamental skills are practised and physical literacy is developed.

It is important for the acquisition of daily living FUNdamentals to take place as soon as possible after the onset of a disability. The ability to perform basic transfers from vehicle to chair, and chair to sit-ski should be acquired prior to learning basic sport skills, especially if the individual has low upper body strength. Coaches should be aware of this because support is often focused on arranging basic living elements (i.e. transportation, finding new schools, doctor appointments, surgeries, etc.) rather than developing these important skills.

The physical literacy skills needed by children with a disability vary greatly depending on the nature and extent of their disability. They should include all the same skills learned by able-bodied children (modified as required), as well as the additional skills required for effective use of assistive devices.

Regardless of their previous physical skill, individuals who acquire a disability often have to learn new physical literacy skills in order to use a sit-ski, use a prosthetic limb or accommodate a restricted range of movement. Even if the athlete is an adult, it is critical that he/she learn the FUNdamentals of new movement and sport skills (with the new body), so that those skills can be applied to a wide range of sports and recreational activities.

NOTE: Approximately 25% of children with disabilities will require help with everyday activities, including personal care (e.g. bathing, dressing, feeding, moving about within the home), because of a medical condition or health problem.

Specialization

Disability sports are late specialization sports. It is critically important that children with congenital or early-acquired physical disabilities be exposed to the full range of FUNdamental movement skills before specializing in a sport. Similarly, adults with an acquired disability should master their new FUNdamental movement skills before specializing in a sport.

It is also important that children with an intellectual disability be exposed to the full range of FUNdamental movement skills before specializing in a sport.





Age Factors

Some congenital disabilities are known to influence childhood/adolescent development and the timing of puberty (i.e. children with spina bifida are known to experience puberty earlier than their peers). However, although the timing of puberty may vary, the sequence of development that the child/adolescent goes through is likely to remain the same.

It is important to note that due to the variations in the timing of puberty (and therefore peak height velocity), it is probable that there will be variations in the ages at which windows of optimal trainability occur. However, in the absence of definitive data to indicate otherwise, athletes with congenital disabilities should follow the same development pathway and timelines as able-bodied athletes. For those who have suffered a traumatic injury (acquired disability), no research has been done to determine when optimal training occurs.

Much more research is needed before a full understanding of these areas is achieved.

Children with intellectual disabilities often enter puberty early but complete the process later than their peers.

Trainability

Very little is known about periods of optimal trainability for individuals with a disability. In the absence of information to the contrary, it is therefore suggested that for children with a congenital disability, the ages of optimum trainability, as shown in section 2.5 of this Reference Material, be adjusted based on the observed age of puberty. Whether or not there are optimal periods of trainability during post-injury rehabilitation still needs to be investigated.

Medical operations and drug therapy may also delay Peak Height Velocity (PHV), Peak Weight Velocity (PWV) and Peak Strength Velocity (PSV), either as a result of training interruptions or a lengthy recovery period (months to years).

Athletes who acquire a disability after adolescence will already have gone through the periods of optimal trainability pre-disability, and an assessment will be required in order to determine what the athletes' training needs are.

More research is needed to understand optimal athlete development.

Source: No Accidental Champions

Training and Competition Partners

For athletes with a disability, training and competition partners are an essential and integral part of their sport experience. Therefore, it is important that the support for the training and competition partners be equal to the support for the athletes (with a disability) themselves. It is also important to match athletes and partners appropriately. For skiers in the early stages of





development, finding a ski partner with comparable ski abilities is usually adequate. However, as skiers strive for higher levels of performance, it is important to have training and competition partners that are paired more closely based on physique, skill level and fitness. Recent retirees from National Ski Team and college/university racing teams often transition well into these roles.

To continue to improve sport performance, athletes' training and competition partners need to be equally committed to the sport, and they need to be recognized as athletes in their own right. As athletes with a disability improve, they may need to replace their existing - and sometimes long-term - partners with partners whose athletic performance can keep pace with theirs. Athletes cannot improve and become successful at higher levels of competition if they seriously outperform their partners or become incompatible with a partner who is working with them.

Athletes with visual impairment cannot usually travel, train or race without a sighted guide.

Athletes with severe disabilities may not be able to participate in sport beyond the recreational level. If they are able to participate in competitive cross-country skiing they may require a custodian or companion to look after their daily needs while they are traveling, training or at races. Daily living support for athletes who require it allows them to focus more on their training and performance and less on daily logistics. On the other hand, a lack of daily living support will make their progression up the LTAD stages challenging, and may even result in health issues (e.g. untreated pressure sores).

Physical, Mental, Cognitive and Emotional Development

Sport can play an invaluable role in helping individuals with a disability develop self-confidence and self-worth, as well as in learning how to set and achieve personal goals.

Teens with disabilities are particularly vulnerable, and may have difficulty forming a healthy self-image. Teens with disabilities that are physically apparent will be very aware of how their appearance differs from society's desirable image. As a result, peer relationships and fitting in with a peer group are critically important to help them to establish their own unique identity.

Although self-esteem and self-image are promoted by participation in sport, few school sport programs are adapted to children and teens with disabling conditions. To better understand the disabilities of student athletes, teachers and coaches should refer to the International Paralympic Committee (IPC) website at www.paralympic.ca, or participate in NCCP training for coaches of cross-country skiers with a disability.

Consideration of mental, social and emotional development is particularly important when working with athletes with an intellectual disability. The development of characteristics and implications for coaches needs to be interpreted in light of each athlete's mental and developmental age, rather than chronological age.





Periodization

There is little or no research evidence that periodization for athletes with a disability is substantially different from that for able-bodied athletes. However, there is some evidence to indicate that:

- ❑ quadriplegic athletes do not have the ability to raise their heart rate, and as a result all adaptation is in the peripheral muscles; and
- ❑ quadraplegics have problems with regulating their body temperature (including an inability to sweat when hot), and athletes with spinal cord injuries above T6 may experience automatic dysreflexia - a sudden rapid increase in heart rate and blood pressure that poses a serious health risk.

These factors may need to be taken into consideration when using periodization as a planning technique.

In the LTAD context, periodization connects the developmental stage the skier is in to the requirements of that stage. It is therefore an essential component of optimal sports programming and athlete development at all levels

Facilities

In order to offer cross-country ski programs to individuals with a disability, it is important to have access to a ski facility that is accessible to them. For example, ski trails need to be marked differently because a moderate downhill for an able-bodied skier may be a dangerous downhill to a visually impaired skier or sit skier. Another example would be the need for a warm building at the trail head, as the body mechanisms that keep athletes with some disabilities warm may not be as efficient as those of an able-bodied skier.

Equipment

Specialized equipment may be required. A sport-specific example of this would be sit-skis or kneeling sleds, which are commonly used by skiers with disabilities. Individuals starting out rarely have this equipment, however, and this is a costly investment for clubs to undertake. To help meet this challenge, interested groups or individuals are encouraged to contact their provincial sport organizations (divisions of Cross Country Canada) for information on what is being recommended for that region. Equipment considerations include the following:

- ❑ **First Contact/FUNDamentals and Learning to Train.** Children need equipment designed for their age, size, strength and skill. This is critical to making early experiences positive and will pay off by encouraging a life-long love of physical activity and sport, which in turn benefits their health.
- ❑ **Training to Train through to Training to Compete.** It is essential for the equipment to be fitted to the athlete properly for optimal performance during the “excellence” stages. For example, sit skis and kneeling sleds need to be custom made in order to fit each athlete’s high performance requirements.
- ❑ **Training to Win.** The sport scientists who work with athletes at this level have to develop partnerships with equipment manufacturers in order to design the innovative world-





class equipment that is required to give athletes a competitive advantage in international competition.

- ❑ **Correct Prosthesis.** For those athletes who require them, selecting the correct prosthetic limb is essential for optimal performance. For example, most individuals who ambulate throughout the household and community will find that a solid-ankle cushion heel (SACH) prosthetic foot is efficient and meets their needs, while most competitive athletes would prefer to use the newly-developed dynamic response prosthetic foot (the dynamic response foot deforms under a load but retains the memory of its pre-stressed configuration and returns it to its original shape upon removal of the load).

Skilled Technicians and Sport Scientists

In all LTAD stages, skilled technicians play an important role in ensuring the equipment and ski preparation needs of athletes are met. In particular, skilled technicians are needed to give athletes pursuing personal excellence a competitive advantage by taking information from sport scientists and finding suitable methods of applying it to the athletes they are working with.

Sport scientists make a major contribution to physical literacy through research in the areas of optimum acquisition of skills, establishment of effective learning environments and the identification of activities and teaching methods that enhance the learning of FUNdamental movement skills. However, a particular emphasis needs to be placed on finding out more about the early skill learning of children or adults with a disability, about which little is currently known.

At the Training to Train, Learning to Compete and Training to Compete stages of LTAD, sport science can best contribute through optimization of performance techniques and a better understanding of the individualization of the interface between the athlete and their adaptive sporting equipment. This may also include strapping methods. In addition, refinement of training loads based on periodic evaluations of physiological status and development of sound sport psychology programs, both based on the developmental age of the athletes, is important.

Injury patterns have been identified for certain groups, with wheelchair athletes typically sustaining upper extremity injuries, blind athletes sustaining lower extremity injuries and cerebral palsy athletes sustaining both. Common problems affecting wheelchair athletes include autonomic dysreflexia, difficulty with thermoregulation, pressure sores, neurogenic bladder, premature osteoporosis, peripheral nerve entrapment syndromes and upper extremity injuries. Cerebral palsy athletes often have injuries involving the knee and foot due to problems with spasticity and foot deformities. Amputee athletes sustain injuries to the stump, spine and intact limbs.

At the Training to Win stage, athletes need state-of-the-art physiological, biomechanical and psychological testing and training prescriptions. Coaches, athletes and parents need to understand existing sport science, and sport scientists need to undertake original and applied research on sport performance techniques, training methods and equipment designed to give these athletes a competitive advantage at the international level.

Intellectually disabled athletes may also have underlying ocular and visual defects, congenital cardiac anomalies and atlantoaxial instability that predispose them to injuries.





Competition Calendar Planning

- ❑ **International Competition.** At the international level, cross-country skiing is governed by the International Paralympic Committee (IPC), in conjunction with the IPC Nordic Skiing Technical Committee, which uses modified rules of the International Ski Federation (FIS) for all sanctioned competitions. This Committee also uses modified rules of the International Biathlon Union (IBU) for governing sanctioned competitions in the sport of biathlon.

International competition is open to athletes with a physical disability and blindness/visual impairment. A person in a wheelchair, depending on functional disability, uses a sit-ski. Athletes with blindness/visual impairment ski with a sighted guide. Male and female athletes compete in short distance, middle distance and long distance races ranging from 2.5km (female sit-ski and relays) to 20km (male standing and visually impaired). They also participate in team relays using both classic and skating techniques. The first international competition was held at the 1976 Paralympic Winter Games in Örnsköldsvik, Sweden. By 2006, 24 countries were competing in the cross-country skiing and biathlon arena. Individual sprint events are now beginning to appear at World Cup and World Championships events.

Internationally, Canadian athletes compete in one of three categories: visually impaired, standing and sitting. Domestically, two categories are offered - standing and sitting.

Domestic Competition. At the domestic level, cross-country skiing is governed by Cross Country Canada. Athletes need access to competitions with well trained ancillary personnel such as officials, classifiers and guides, plus custodians for severely disabled athletes, to make sure that their needs are met.

Providing enough competitions to allow for optimal development opportunities is a major challenge due to the small number of athletes in the system and the fact that they are divided into many groups according to different disability types. Divisions and clubs have to be creative to ensure that athletes get opportunities that are suitable for their age, skill and fitness levels. The percentage classification system helps to reduce the scale of this challenge.

The structure of cross-country ski competitions encourages the integration of able-bodied skiers and skiers with a disability at Provincial Cup, NorAm, National Championships and Canada Winter Games competitions.

- ❑ **Local Competition.** Local, fun events with little or no focus on results can provide a non-threatening environment for introducing athletes to competition. This is also an effective way to gain exposure in the community for club programs for athletes with a disability.





Figure 1: Competitor Pathway for Athletes with a Disability

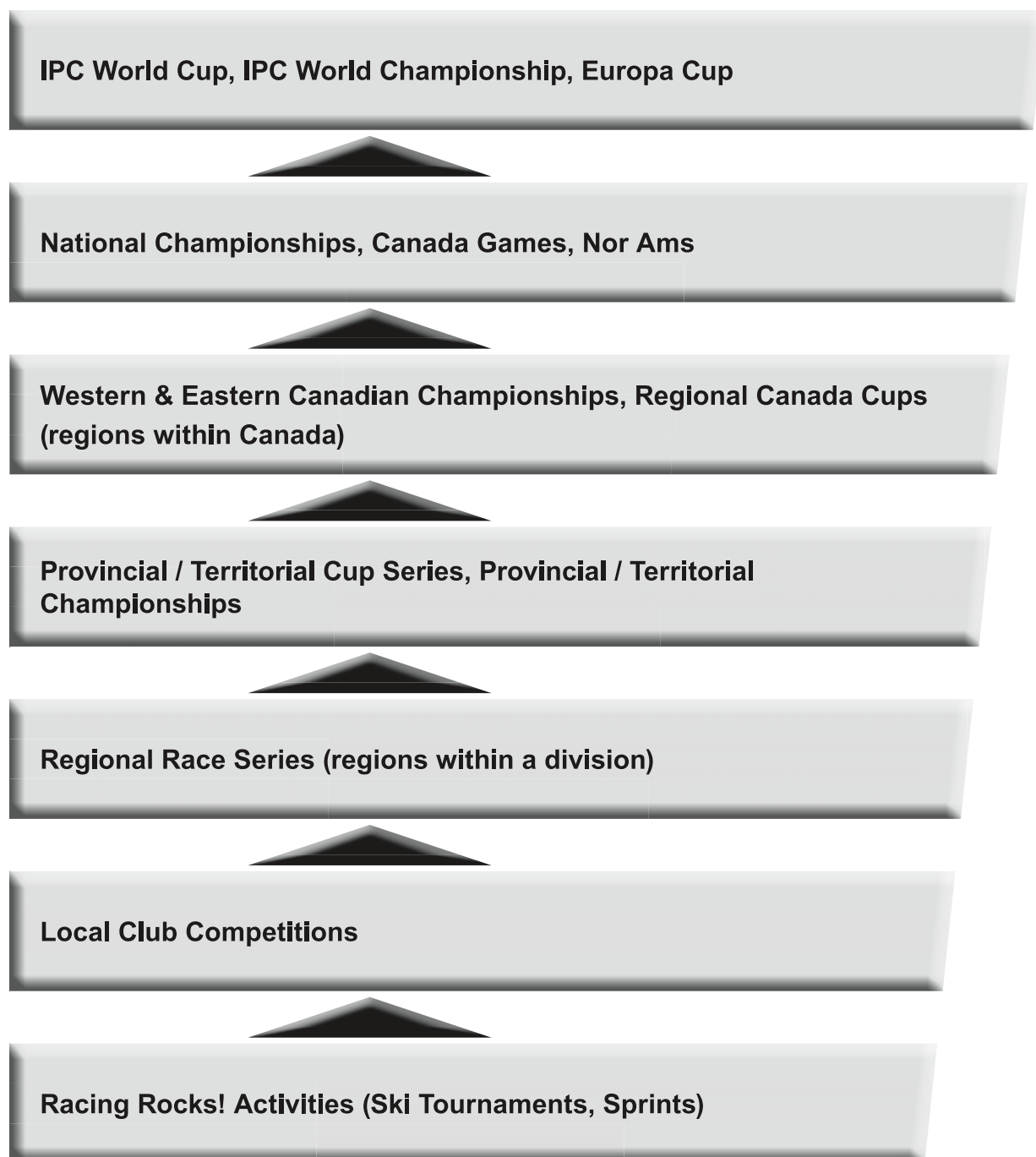



A.3 Stages of LTAD for Athletes with a Disability

While there are many similarities between athletes with a disability and able-bodied athletes, there are also some differences that can change the LTAD process.

To better understand LTAD for athletes with a disability, it is important to keep the following points in mind:

- ❑ Athletes with congenital disabilities progress through the LTAD stages at the same age as able-bodied athletes.
- ❑ The lifelong importance of an “Active Start” for children with a congenital disability cannot be over-emphasized.
- ❑ Athletes who acquire their disabilities still need to make an active start and learn (or re-learn) fundamental movement and sport skills, but they do this following their injury (which can occur at any age), using new techniques and equipment in order to maximize the potential of their remaining physical capacities.
- ❑ Athletes who acquire their disabilities may pass through the various LTAD stages at significantly different ages and much more quickly than those with congenital disabilities, and faster or slower than one another following their injury – depending on a number of factors.

The period following acquisition of a disability is understandably one of transition and great change for most individuals. Some activities in which they were previously engaged may no longer be open to them in the same way, and they may not be aware of the many sporting and recreation activities that are available. The purpose of the Active Start/Awareness and FUNDamentals/First Contact stages is, therefore, to inform individuals of the range of activities in which they can participate and to provide ways for them to experience those activities.

Research indicates that sports may only have one opportunity to create a positive environment and recruit prospective athletes. For the individuals, it may be a big step to make the first approach to a sport. If they don't have a positive first experience, they may be lost to the sport - and to a healthy lifestyle.

LTAD considerations are essentially the same for athletes with congenital disabilities as they are for able-bodied athletes.





A.3.1 LTAD Progression Chart

Active Start / Awareness	Males and females 0 – 6 years (congenital disability) <i>or</i> <1.5 years since accident or onset (acquired disability)
FUNdamentals / First Contact	Males 6-9 and females 6-8 years (congenital disability) <i>or</i> About 2 years since accident or onset (acquired disability)
Learning to Train	Males 9-12 and females 8-11 years (congenital disability) <i>or</i> About 3 years since accident or onset (acquired disability)
Training to Train	Males 12-16 and females 11-15 years (congenital disability) <i>or</i> About 5 years since accident or onset (acquired disability)
Learning to Compete	Males 16-20(+/-) and females 15-19(+/-) years (congenital disability) <i>or</i> About 7 years since accident or onset (acquired disability)
Training to Compete	Males 20-23(+/-) and females 19-23(+/-) years (congenital disability) <i>or</i> About 8 years since accident or onset (acquired disability)
Training to Win	Males 23(+/-) and females 23(+/-) years (congenital disability) <i>or</i> >8 years after accident or onset (acquired disability) + >2 years of international racing experience
Active for Life	This stage can be entered at any age There is a better opportunity to be Active for Life if physical literacy is achieved before the Training to Train stage

Time can vary considerably depending on the individual's response to the acquired disability and their pre-disability athletic and/or skiing experience.





A.3.2 Active Start/Awareness

Able-Bodied or Congenital Disability	Acquired Disability
Ages: males and females 0 – 6 years (congenital disability)	< 1.5 years since accident or onset (acquired disability)

The goals outlined in this section supplement the goals and specific tasks for the corresponding LTAD stage in the able-bodied model for cross-country skiing.

The goals include:

Congenital Disabilities

- Emphasizing activities that are gender-neutral and inclusive to pro-actively encourage active living, because people with a disability tend to be less active than their peers.
- Integrated programming with CCC's Skill Development Program for children – the Bunnyrabbit Program.

Acquired Disabilities

- Developing a plan to make cross-country skiing known to prospective athletes.
- Educating individuals with a disability, and their families, about cross-country skiing opportunities that are available to them.
- Providing demonstrations and/or initiation opportunities in an appropriate setting, with qualified coaches.
- Introducing adaptive skiing equipment such as athletic sport prosthesis and sit-skis.
- Assisting individuals who wish to try out the sport to find ski equipment that is appropriate for them in size, weight and design.
- Encouraging CCC clubs to offer programs for athletes with a disability.
- Creating a positive sport environment.
- Encouraging individuals with a disability to try out a variety of sports.
- Improved collaboration between coaches and medical professionals in order to monitor skiers appropriately and ensure their safety.

Note: For individuals with a late-acquired disability, the Active Start/Awareness stage usually merges with the FUNdamentals/First Contact stage, as progress is normally rapid (depending on the individuals' stage of LTAD development in this or other sports pre-injury).





A.3.3 Fundamentals/First Contact

Able-Bodied or Congenital Disability	Acquired Disability
Ages: 6 to 9 years (males), 6 to 8 years (females)	About 2 years since accident or onset of disability

The goals outlined in this section supplement the goals and specific tasks for the corresponding LTAD stage in the able-bodied model for cross-country skiing.

The goals include:

Congenital Disabilities

- Integrated programming with CCC's Skill Development Program for children – the Jackrabbit Program.

Acquired Disabilities

- Educating athletes on the importance of having good mental skills to help them deal with their new challenges and develop themselves as athletes; introducing mental training techniques.
- Athletes successfully re-learning the FUNdamentals with their new/modified body (late-acquired disabilities). The length of this process is dependent on the individual.
- Assisting individuals to find ski equipment that is appropriate for them in size, weight and design (ongoing).
- Providing cross-country ski skill development opportunities in an appropriate setting, with qualified coaches.
- Athletes exploring a variety of sports before specializing.
- Improved collaboration between coaches and medical professionals in order to monitor the skier appropriately and ensure their safety.
- Encouraging interested individuals to become members of a CCC club.





A.3.4 Learning to Train

Able-Bodied or Congenital Disability	Acquired Disability
<p>Ages: 9 to 12 years (males) 8 to 11 years (females)</p> <p>Change in height cue is to be utilized as a guide to appropriate programming towards the end of this stage</p>	<p>About 3 years since accident or onset of disability</p>

The goals outlined in this section supplement the goals and specific tasks for the corresponding LTAD stage in the able-bodied model for cross-country skiing.

The goals include:

- Integrated programming with the CCC's Skill Development Program for children – the Track Attack Program.
- Building upper body strength to improve mobility, so that the individual can be involved in sport activities.
- Developing balanced antagonistic muscles (both sit-ski and standing skiers).
- Adapting dryland training techniques appropriately for skiers with a disability.
- Educating coaches and athletes about strapping.
- Increasing participation in complementary sports such as rowing, track and cycling.
- Incorporating NCCP CCI-L2T (On-Snow) Reference Material - including the appendix for coaching athletes with a disability.
- Reviewing Canadian Paralympic Committee website: www.paralympic.ca.

A.3.5 Active for Life

This stage can be entered at any age, but ideally it will follow the Learning to Train stage or take place when an athlete leaves the competitive stream.

There is a better opportunity to be Active for Life if physical literacy is achieved before the Training to Train stage.





A.3.6 Athlete Development Pathway Chart

Responsibility	LTAD Stages	Critical Success Factors	4 to 8 (9) years	(8) 9 to 11 (12) years	(11) 12 to 15 (16) years	(15) 16 to 19 (20) years	(19) 20 to 23 years	23 + years	Outcome
National Sport Organization (NSO)	Training to Win	<ul style="list-style-type: none"> NCCP Certified coaches Athlete selection criteria Athlete training programs Sustainable competitions International competition Sport science support Customized equipment 							National Level Athlete
	Training to Compete								
	Learning to Compete								
Provincial/Territorial Sport Organization (P/TSO)	Training to Train	<ul style="list-style-type: none"> NCCP certified coaches Athlete selection criteria Athlete training programs Sustainable competitions 							Provincial Level Athlete
	Learning to Train								
CLUB	FUNDAMENTALS/ First Contact	<ul style="list-style-type: none"> NCCP trained coaches Regular training/ practices Sustainable leagues and competitions Disability knowledge/ understanding 							Club Level Athlete (Active for Life)
	Active Start/ Awareness								
Athlete enters the para-sport system									



**A.3.7 NCCP: AWAD Stream**

ATHLETE & COACH DEVELOPMENT PROGRESSION		
LTAD Stage	NCCP Context	AWAD Stream
Training to Win (T2W)	Competition Coaching: High Performance (CCHP)	TBD
Training to Compete (T2C)	Competition Coaching: Development Advanced (CCDAG – T2C)	TBD
Learning to Compete (L2C)	Competition Coaching: Development (CCD – L2C)	
Training to Train (T2T)	Competition Coaching: Introduction (CCI – T2T)	9) T2T (On-Snow) Workshop 8) T2T (Dryland) Workshop 7) CCI (Dryland) AWAD Module 6) CCI (On-Snow) AWAD Module 5) L2T (On-Snow) Workshop 4) L2T (Dryland) Workshop
Learning to Train (L2T)	Competition Coaching: Introduction (CCI – L2T)	
FUNDamentals/First Contact	Community Coaching: (CC)	3) CC AWAD Module 2) CC Workshop 1) ICC Workshop
Active Start/Awareness	Community Coaching: Introduction (ICC)	





A.3.8 Athlete Development Grid

LTAD Stage	Responsibility	Requirements	Key Objectives
Active Start / Awareness <ul style="list-style-type: none"> Demonstration and initiation into sport by Rehabilitation Centre, publicity, specific AWAD associations and special activities. Physical educators, physical therapists, friends, family, volunteers... 	<ul style="list-style-type: none"> Sport for Disabled Organizations (SDO). Assisted and customized delivery through CCC clubs and other key stakeholders. Centralized leadership and programming (i.e. Feel the Rush). 	<ul style="list-style-type: none"> A ski area that is accessible to athletes with a disability. Appropriate ski equipment. NCCP trained coaches for athletes with a disability. No previous experience. Medical practitioner support. Transportation to and from ski area. 	<ul style="list-style-type: none"> Making access to cross-country skiing known. Ensuring a positive environment. Encouraging participation in many sports. Athlete participation in Ski S'Kool Days, Club Open House Days. Athlete participation in introductory, club-delivered, skill development programs.
FUNDamentals / First Contact <ul style="list-style-type: none"> Initiation to cross-country skiing by other athletes, Rehabilitation Centres, word of mouth, publicity, SDOs and special activities. CCC community coaches, physical educators, physical therapists, friends, family, volunteers.... 	<ul style="list-style-type: none"> SDO. CCC Clubs. 	<ul style="list-style-type: none"> Accessible ski area. Appropriate ski equipment. NCCP trained coaches for athletes with a disability. Rehabilitation. Regular practices during snow season. Up to 100 hr/yr on snow. 0 to 1 year of experience (acquired disability). Medical practitioner support. Transportation to and from ski area. 	<ul style="list-style-type: none"> Ensuring a positive environment. Educating the athlete and their family on stages of development, other sports. Athlete participation in club-delivered skill development programs. Athlete participation in introductory competitions such as Ski Tournaments.





LTAD Stage	Responsibility	Requirements	Key Objectives
Learning to Train	<ul style="list-style-type: none"> • CCC Clubs 	<ul style="list-style-type: none"> • Accessible ski area. • Appropriate ski equipment. • NCCP trained coaches for athletes with a disability. • Regular practices during snow season. • Up to 200 hr/yr (50 % on snow; 50% off-season). • 0 to 2 years of experience (acquired disability). • Medical practitioner support. • Transportation to and from dryland and on snow sport facilities. 	<ul style="list-style-type: none"> • A positive environment. • Athlete participation in intermediate-level, club-delivered skill development programs. • Athlete participation in Learn-to-Ski Clinics and entry level camps specifically for athletes with a disability . • Successfully introducing athletes to structured competition through observation and through participation in low-key competitions.





A.4 Considerations for Working with Athletes with a Disability

A.4.1 General Considerations

Persons with One-Sided Disabilities

Someone who has the use of one hand or arm only faces a number of challenges when using a typical building. For example, locked doors require the use of two hands. Bathtub and hand rails are left or right sided and may be situated on the “bad” side of the user. This disability is even more of a problem for those individuals with poor balance or poor muscle control who need to use their one good hand to maintain body stability.

Persons with disabilities on one side often have a problem in both their arm and leg. This condition makes them vulnerable to accidental falls because of their reduced balance and their inability to check imbalances. Additional body support is needed in situations where the individual’s posture is unstable or changing – for example, when using stairs or toilet facilities. In these cases, good footing is needed at all times.

Persons in a Wheelchair

There is a wide variation in the physical capabilities of persons who use wheelchairs. Some individuals have weak arms and can’t propel themselves over floor surfaces such as soft carpets or slight inclines. Others have strong arms and can stand for short periods of time, given adequate grab rails.

The seated position of the person in a wheelchair creates an eye-level and an area of reach that differs greatly from that of a standing, able-bodied person. Everything that must be reached, such as shelving, notices or switches, and everything that must be seen into or through, such as windows, mirrors and drawers, needs to be lower than those for a standing person.

Someone using a wheelchair requires considerably more space to manoeuvre than an able-bodied person does (see Figure A.1 & A.2). Moreover they are limited to a smaller number of acceptable floor conditions. A standard wheelchair is 24 inches wide, 42 inches long and requires a circle 60 inches in diameter in order to turn completely around. The most frustrating and handicapping situations experienced by those in wheelchairs involve mobility, and the barriers created by steps, stairs, poor flooring surfaces, narrow doorways and heavy doors. A wheelchair can navigate a 76 cm door with ease. However doors are often 26 inches [66 cm] wide and a wheelchair can barely squeak through.

People in wheelchairs can often use the bathroom facilities even if they aren’t designed to accommodate wheelchairs. However, negotiating the doorway in order to reach the facility is frequently problematic as the entrance way can be as narrow as 24 inches [61 cm].

Often persons that use wheelchairs lack feeling in their legs, and they can easily hurt themselves by leaning against a hot radiator or bumping into sharp objects.





Figure A.1: Space for a 3-point turn

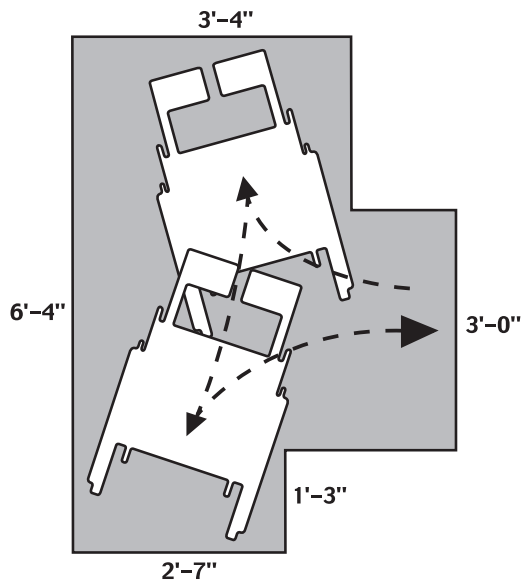
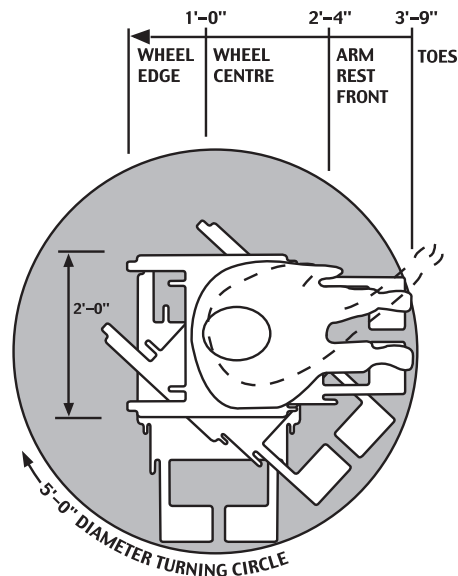

Figure A.2: Space required for complete turn



Persons who are Visually Impaired

- ❑ Speak directly to the individual. Don't ask their spouse or guide if they want "cream in their coffee" - ask them. They will not have problems with ordinary table skills and can manage without help. What they will want to know is who is in the room with them. Speak to them when you enter a room they are in, and when they are entering a room, introduce them to the others in that room. Don't avoid words like "see". They will use these words too.
- ❑ People who are visually impaired may use a long white cane or dog-guide to walk independently, or they may ask to take your arm. Let them decide if they want your help. Don't grab their arm; rather, let them take yours. They will keep a half step behind to anticipate curbs and steps. In many places, the law requires drivers to yield the right of way when they see the white cane.
- ❑ A partially open door to a room, cabinet or car can be a hazard. Be alert to this risk.
- ❑ Don't mention the "wonderful compensations" of visual impairment. Their sense of smell, touch and hearing didn't improve when they lost their sight. They rely on these senses more and therefore may get more information through them, but that's all. They will likely discuss their blindness with you and answer questions if you're curious - but this is an old story to them. They have as many other interests as you do. They are just a person who happens to be visually impaired.

Functional Facilities

The basic requirements for a functional facility for the population at large are accessibility and usability: everyone should be able to reach a desired area within a building and once there they should be able to use the facilities provided. For a cross-country ski facility, accessibility involves not only movement within the building but also movement from the street or parking area through the building entrance to the stadium and ski trails.





A building that provides wheelchair access is one that is accessible to most people who are disabled but mobile.

Major Problem Areas

Parking lots, building entrances and toilet facilities are the functional areas in which persons with a disability seem to have the greatest problems. Specific areas of concern include the following:

- Steps, narrow doorways and doors that are positioned too close together for wheelchair access.
- Toilet facilities that are difficult for a person in a wheelchair to access due to:
 - ✓ insufficient space (particularly in the stalls);
 - ✓ fixtures that are designed for persons in a standing position; and
 - ✓ doorways that are too narrow.
- Taps and doors: arm amputees (especially double arm amputees) often have difficulty turning taps and opening doors.
- Snow piled at the edge of a parking lot: the snow piles can prevent persons with a disability from reaching the ski area/ski trail without assistance.

A.4.2 Considerations Specific to Cross-Country Skiing

Getting a Program Started

- Ensure that the type of disability and level of ability of each participant in your program are known before activities get underway.
 - ✓ Ask the parents / guardian to meet with their family doctor to ensure the individual is able to ski, and to fill in a comprehensive medical form provided by your club.
 - ✓ Undertake an initial assessment prior to the ski season will also allow you enough time to prepare or modify equipment to meet the needs of the individual skier.
- Keep a copy of the medical record at the ski area if the skier is on special medications or is subject to seizures. This will be useful to the paramedics in the event of an incident.
- If necessary, prepare novice skiers with a pre-ski season conditioning program so that they can participate comfortably in the on-snow practice sessions.
- Meet your skiers at the same location for every practice session and be prepared to assist with their equipment if needed.

The Teaching Area

Introduction to skiing should begin on a flat, well packed snow surface.

Ideally, the ski facility in your community will be wheelchair accessible. If not it can usually be accessed with some assistance. If a person with a disability needs assistance from the parking





lot to the area where they will be skiing, you can use a rope or strap that is approximately 2.2 metres long to pull them.

Beginner sit-skiers will not be able to ski more than one kilometre without assistance. Most trails will be skiable as long as there is assistance to push them on the uphill and brake them on the downhill.

Practice Session Tips

- Determine the abilities of the participants without isolating them or singling them out.
- Be sensitive to the individual's needs and abilities, and gear your expectations accordingly.
- Focus on fun and participation!
- Use common sense - don't put the athlete at risk of physical injury or exhaustion.
- Encourage independence, and focus on abilities, not disabilities.
- Encourage and facilitate two-way communication appropriate to the capability of the individual participant.
- Seek additional human resources if you need to modify equipment or technique.

Figure A.3

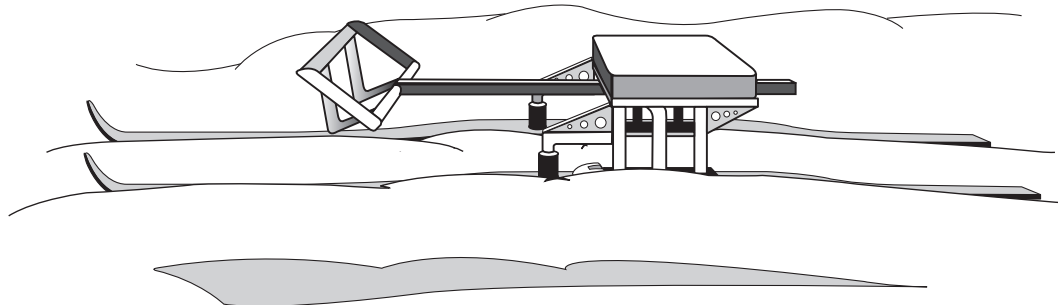

Persons Requiring Sit-skis

The sit-ski (Figure A.3) is the cross-country skiing version of a wheelchair. In order to properly address the particular needs of a person who normally uses a wheelchair, you will need to know and understand the nature of the person's disability. For example, the person using the wheelchair may not be paralysed - they may have a high leg amputation or angulated fractures and be unable to wear a prosthetic.

To better understand the nature of the disability, ask yourself the following questions: (1) can the individual move one or both legs, and (2) do they have the use of their abdominal muscles?

1. If the individual can move his/her legs, then he/she will be able to balance and twist his/her body with strength. In this case you will be able to teach the individual Double Poling directly. Even the bending of the knees is the same as for an able-bodied skier.





2. If the individual cannot move his/her legs and cannot control his/her abdominal muscles, then he/she will have the greatest challenge and require the most adaptation to his/her technique in order to ski. A high level break or paralysis causes both forward-backward and side-to-side instability. These individuals are unable to regain a vertical position once they have flopped forward onto their knees, so mechanical assistance is needed to keep them upright. A wide (ten centimetre) elastic strap fastened to the back and seat of the sit-ski seat can provide support from the knees to just below mid-chest height.

Note: an athlete in a sit-ski is confined to poling (either Double Poling or Off-set Poling). Guidelines for determining pole length are the same as for a standing skier. Side-to-side instability is controlled by having a sit-ski seat which hugs the skier and is quite rigid. This rigidity can be accomplished by having a sled with high sides and straps.

After several years in a wheelchair, individuals with a disability may lack flexibility. For example, they may not be able to touch their hands behind their back. Because of this their range of flexibility and their ability to balance with their arms outstretched should both be tested. Flexibility exercises should therefore be part of their lesson plan from the beginning. Massage therapy is usually recommended if the person intends to become proficient and have a full range of motion.

The first time out you should have an assistant to help you move the person from the wheelchair to the sit-ski. Most people with a disability do not like to be lifted, so they should be asked first to see if they would like assistance. If they wish to be lifted, they should be asked to explain how they would like the manoeuvre done, as they will have done this many times before. At all times you should be careful of your own back while lifting, holding or righting sit -skiers.

Figure A.4

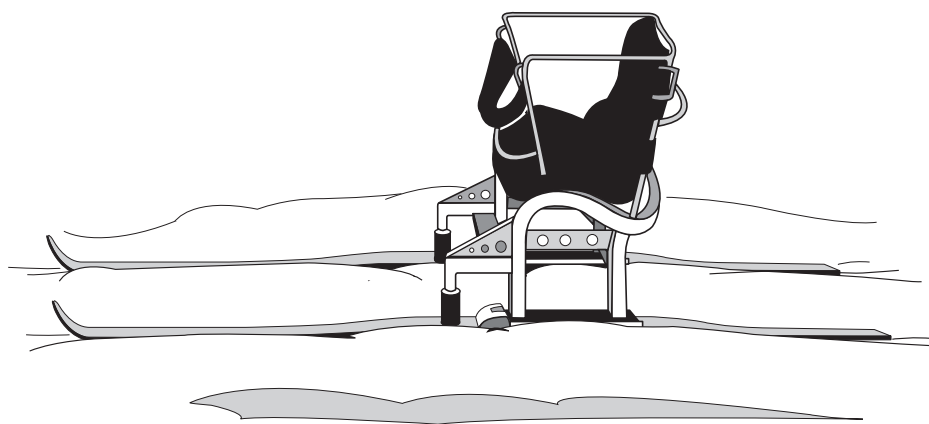

Teaching Tips:

- ❑ The arms provide the only power. For beginning skiers, they will collapse onto the chest to compensate for the lack of strength. With good instruction, practice and specific training to increase strength in the arms, shoulders and abdominal muscles (if useable), the sit-skier will be able to achieve the same power that able-bodied skiers achieve.
- ❑ Sit-skiers can only slow or stop their sleds by digging in the hand-grip ends of their poles (preferred braking method) or the tips (basket) of the poles. Beginner skiers should therefore have their sleds adjusted so that they can reach the ground easily. Alternatively, they can be tethered when going downhill, with you or an assistant coach snowplowing behind the sit-ski.





- ❑ Cornering on downhill turns is a matter of balance, body position and braking. Skiers with a strong upper body will be able to use their outside pole to push quickly, in a jabbing motion, to force the sit-ski tips inside the fall line and the ski tails to the outside. Good balance is needed to keep the sit-skier upright and to avoid the tendency to jerk as the skis grab (in the same way that able-bodied skiers need to learn to feather or side slip with parallel skiing).

Persons with Leg Amputations or Weak Legs

- ❑ Double Poling is the easiest technique for an amputee to learn. The One-Step Double Pole technique is easily learned by the leg amputee skier because the leg is frequently used in a locked position. The arms provide most of the power. The arms will collapse onto the chest to compensate for the lack of leg power. With practice and training, an increased strength in abdominal muscles and a powerful leg kick can be developed.
- ❑ In general, athletes with a disability will start skiing with the prosthetic leg bent and the other leg stiff. The body will be in an upright position with no weight shift from leg to leg. Occasionally, the prosthetic leg will collapse as the prosthetic joints don't lock. Weight transfer with the foot going ahead of the other can be achieved by the amputee skier. The prosthetic leg can be pushed ahead of the other foot. A skier with a prosthetic can step around on curves of fairly steep terrain without any problems. The Step Turn allows control of speed and direction without use of the Snowplow technique. Compared to able-bodied skiers, the body position is more upright to enable the knee to be locked while stepping.
- ❑ Disabled skiers will normally begin to perform skating techniques with their feet wide apart in order to lock the leg. With the feet wide apart in this way, the skis move towards the trail edge rather than down the track. In addition, there is a lack of weight transfer and the skis are providing very little glide on either foot. Most of the skier's momentum is supplied by the lower arms. This expends a lot of energy unnecessarily. With instruction and practice, skating techniques can be performed with weight transfer so that both feet move underneath the body. The gliding motion can be graceful without strain.
- ❑ Steep hills will force amputee skiers to adopt a more upright than is desirable. The need to lock the leg will cause an ataxic gait pattern and upright body position. Technique modification should occur such that the motion of skiers with disability is fluid and energy-conserving. Whenever the skiers become tired or challenged with unfamiliar steepness in terrain, a reversion to the gait pattern may occur.

Persons with Visual Impairment

Teaching Tips:

- ❑ First determine the extent of an individual's visual impairment as this will affect your teaching methods.
- ❑ Persons with visual impairments may initially have issues with balance, timing and the judgement of speed. However, with practice, they can overcome these problems.
- ❑ A visually impaired skier should have a guide who skis where they specify - either in front, back or side.





- ❑ Specific verbal cues about the direction and terrain are essential. Using clock references - for example, "Turn at 2 o'clock" - are especially helpful.
- ❑ Physical assistance (see illustration at right) is important initially because it helps develop the correct stance. For example - touching the skier's arm to help him/her feel proper form and motion. Assistance can gradually be reduced to verbal instructions.
- ❑ Be prepared before starting down a hill. Ensure that both the skier's body and skis are positioned correctly!
- ❑ Use standard progressions when teaching, and pace your teaching according to the individual skier's capacities.
- ❑ Be alert to the skier's needs - cold, fatigue, etc.
- ❑ Give lots of encouragement.

Figure A.5



The following conventions are in place for visually impaired skiers, their coaches and guides:

- ❑ The "Trail Safety" guidelines for cross-country skiing (section 6.4 of the Introduction to Community Coaching Reference Material).
- ❑ A skier with no sight should ski in the right-hand track at all times.
- ❑ When skiing on narrow trails, the coach/guide needs to warn their skiers of overhanging branches.
- ❑ Avoid passing on downhills.
- ❑ If snowplowing down a long hill, the coach/guide should explain to their skiers when and how much to slow down.
- ❑ If a skier falls, the coach/guide should encourage him/her to get up quickly to minimize the hazard on the trail. They shouldn't hesitate to help a skier get out of harm's way!
- ❑ When coaching/guiding, you should take the time to describe the surroundings and the terrain. When necessary, stop completely, step out of the track and chat for a few minutes.
- ❑ Use brief commands as follows:

Situation	Command
In an emergency or if your skier is headed for trouble	SIT DOWN!





Situation	Command
On the flats, if a turn is required	GENTLE OR SHARP LEFT/RIGHT TURN
After completing the turn	STRAIGHT AHEAD
Warnings regarding dips or bumps in terrain	DIP COMING UP - NOW! or HUMP COMING UP - NOW!
If part of track is wiped out, but other track is still good	BAD TRACK - FOLLOW LEFT (OR RIGHT) SKI
If one ski is out of the track (left ski in right track or vice-versa)	STEP RIGHT or STEP LEFT
In ski lingo, hills are slack or steep; long or short; uphill or downhill	LONG STEEP UPHILL or SHORT GENTLE DOWNHILL
For a long down hill run with a left turn or right turn	DOWN HILL - TUCK – NOW! or LEFT OR RIGHT TURN – NOW!
The passing command is	TRACK!

Persons with Hearing Impairments

Teaching Tips:

- Hearing impairments don't normally interfere significantly with a person's ability to cross-country ski.
- Persons with severe hearing impairments are sight and touch oriented. When necessary, you can gain their attention by using a specific arm or hand gesture or by touching an arm.
- Some skiers with a hearing impairment may experience problems with their balance. In this case you should advise them that tilting their head back can totally disrupt their equilibrium and cause severe dizziness and nausea.
- Skiers with hearing impairments may not respond to noises in the environment around them such as the sounds other skiers make (for instance, yelling "Track!").
- On public ski trails, including competitions, a hearing impaired skier may choose to identify themselves as such by wearing a bib. The bib will alert others to their needs.
- Your teaching effectiveness will improve if you are assisted by someone trained in sign language.





- Demonstrate clearly when teaching about technique, equipment or waxing.
- Always face the skier you are teaching and speak as clearly as possible. Many individuals with a disability can lip read.

Persons with Especially Poor Co-ordination and Balance

Teaching Tips:

- Use a shorter, wider ski.
- Use progressions, and guide participants through them at a slower pace.
- Give specific, clear instructions – your skiers may have poor body awareness.
- Teach hill maneuvers on a short, slight incline.
- Give your skiers lots of encouragement.





A.5 Modified Games

Description	Effect
Lighter, softer, larger ball	Slows game and allows more time to prepare for and execute skill
Shorter, lighter, striking implement	Allows greater control for weaker and less skilled skiers
Larger striking implement, larger goal or target area	Reduces number of misses and increases opportunity for success
Lighter, softer, smaller balls	More easily caught and retained
Bean bags substituted for balls	Not as elusive as balls and may be easier to throw for skiers with poor hand function
Partially deflated balls for dribbling and kicking	Slows movement of the ball and allows more time to prepare and execute the skill activities

Description	Effect
Skills such as: rolling a ball off a lap for kicking, striking a soccer ball with a floor hockey stick instead of the foot	Increases success and opportunity to be involved in game play
Tasks simplified; for example, drop and catch the ball rather than bounce it consecutively	Increases success and opportunity to be involved in class activity
Props used to enhance skills; for example, a towel extends the reach for tag games	Increases level of success and motivation for participation

Equipment Modifications

❑ Balls:

- ✓ Lighter balls...beach or sponge.
- ✓ Larger balls...monster balls.
- ✓ Balls with tails...foxtails, balls with ribbons attached.
- ✓ Suspend the balls...beach, sponge or cosom balls.
- ✓ Tether the balls...to a walker or a chair.





- ✓ Use brightly coloured balls.
- ✓ Under-inflate the balls.
- ✓ Use scarves, bean bags or koosh balls as alternatives.

❑ **Targets:**

- ✓ Use larger targets or goals.
- ✓ Move targets closer.
- ✓ Raise or lower the target.
- ✓ Use targets with an auditory cue.





REFERENCES

Cross Country Canada, *Long-term Athlete Development Guide for Athletes with a Disability*, 2009.

Canadian Sport Centres, *No Accidental Champions – Long-Term Athlete Development for Athletes with a Disability*, 2006.

Cross Country Canada, *Cross Country Skiing - A Sport for Life*, 2007.

Central Cross Country Ski Association, *Adaptive Nordic Ski Instruction Manual - CXC Adaptive Cross Country Skiing*, 2009-2010.

Active Living Alliance for Canadians with a Disability, *Words with Dignity*.

To learn more about the following sport organizations, visit:

Biathlon Canada: www.biathloncanada.ca

Canadian Paralympic Committee: www.paralympic.ca

Canadian Blind Sports Association: www.canadianblindsports.org

Canadian Cerebral Palsy Sports Association: www.ccpsa.ca

Canadian Deaf Sports Association: www.assc-cdsa.com

International Paralympic Committee: www.paralympic.org

Special Olympics Canada: www.specialolympics.ca





Dear Coach,

The Coaching Association of Canada is pleased to offer you an interactive Web site that enables you to check your accreditation online. Go to www.coach.ca where you can:

- track your progress through the NCCP;
- update your coaching profile;
- print out copies of your coaching card or a transcript of your coaching courses;
- visit the Coaching Tips and Tools section;
- and so much more!



Coaching
Association
of Canada



National
Coaching
Certification
Program